

Equip for
EXCELLENCE
across every field!



Custom-designed
sports uniforms
& teamwear



High-performance
sports equipment



Tailored school
& corporate
merchandise



Reliable on-time
delivery & free
metro shipping

Providing schools, clubs, and organisations with the best in
sports uniforms, equipment, and teamwear since 1978.

SG SLATER.GARTRELL
SPORTS

SG SLATER-GARTRELL SPORTS

Our friendly team are there for you.



Kevin Gartrell



John Gartrell



Robert Gartrell



Mike Wilkie



Chris Pivac



Dani Gartrell

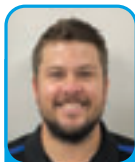

Daine Fisher



Julie Boyden
Life Member



Bill Van Vliet
Life Member



Simon Allison

Contact one of our team members via email: sales@slatertrellsports.com.au

Retail Outlets

MIDLAND

66 Helena Street, Midland 6056

Retail Shop Sales Tel: (08) 9274 5788

Schools & Clubs Tel: (08) 9274 5788

Email: sales@slatertrellsports.com.au

www.slatertrellsports.com.au

Incorporating: Midland Sports Warehouse
ABN 66 075 692 369

Mail Orders: PO Box 2000, Midland 6936

Business Owners

Kevin Gartrell: 0417 102 883

John Gartrell: 0418 657 788

Robert Gartrell: 0419 560 461

Michael Wilkie: 0413 387 641

Specialist Contacts

North of the River School Sales:

John Gartrell: 0418 657 788

South of the River School Sales:

Simon Allison: 0408 645 788

School Sales:

John Gartrell: 0418 657 788

Country School Sales:

Michael Wilkie: 0413 387 641

Office/Account Enquiries:

Dani Gartrell: (08) 9274 5788

Club Sales & Retail Sales:

Michael Wilkie: 0413 387 641

Chris Pivac: 0404 082 623

Synthetic Turf Consultant:

John Gartrell: 0418 657 788

Chris Pivac: 0404 082 623

Warehouse:

Daine Fisher: (08) 9274 5788

HOW TO ORDER

TELEPHONE

Retail Shop Sales: (08) 9250 8053

Schools & Clubs: (08) 9274 5788

Country Free Call: 1800 245 788

(Mon - Fri 8.00am - 5.30pm) (Sat - 8.00am - 1.00pm)

South of the River School Sales: 0408 645 788

North of the River School Sales: 0418 657 788

Email: sales@slatertrellsports.com.au

DELIVERY TIMES AND COSTS

METRO AREA

From: Mandurah - Yanchep - Toodyay
Delivered by your school Rep. FREE of Charge.

COUNTRY

From: Exmouth - Albany - Kalgoorlie - 2 Days
Delivered via School or Club Courier Contract.

From: Pilbara - Kimberleys - 3 Days
Delivered via School or Club Courier Contract.

	PAGE No.		PAGE No.
Agility & Speed	110	Manufacturing	180
Air Horns	13	Markers	182
Archery	3	Marquees	185
Athletics	5	Measuring	19
Awards	21	Medallions	23
Badminton	25	Medical	186
Ball Carts	38	Megaphones	20
Baseball	29	Modcrosse	224
Basketball Backboards	39	Mouthguards	189
Basketball Towers	40	Netball	190
Basketballs	35	Outdoor Education	194
Bean Bags	10 & 60	Physical Education Aids	198
Bibs	41	Pickleball	205
Board Games & Books	43	Post Padding	132
Bocce	198	Pumps & Compressors	37
Books on Sport	48	Rebounders	206
Boxing	96	Resistance Training	88
Classroom Kits	197	Resuscitation Equipment	171
Coaching	44	Ribbons	21
Coaching Balls	67	Rugby	207
Cricket	50	Scoreboards	213
Custom Swim Caps	233	Shot Put	6
Discus	5	Shuttles	26
Display Flags	185	Skipping Ropes	92 & 99
Early Childhood	59	Soccer	214
First Aid	87	Sofcrosse	224
Fitness & Speed	88	Softball	29
Fitness Machines	104	Speedminton	226
Floorball	126	Squash	225
Foam Shapes	85	Stand Up Paddle Boards	231
Football	128	Starting	13
Frisbee Golf	152	Starting Blocks	15
Frisbees	198	Stickers	22
Games	140	Stopwatches	227
Goals	144	Storage	228
Golf	151	Sunscreen	230
Gridiron	208	Surfboards	173
Gymnastics	154	Swimming	233
Handball	156	T-Ball	29
Heart Rate Monitors & GPS Tracking	158	Table Tennis	241
High Jump	8	Teamwear	263
Hit Shields & Tackling Bags	160	Tennis	248
Hockey	162	Timers	254
Hoops	10	Touch	209
Human Physiology	168	Trampolines	254
Hurdles	16	Treadmills	106
Hygiene	167	Trophies	23
Identification	170	Tug-O-War	14
Inflation Devices	37	Volleyball	255
Javelins	17	Vortex	199
Juggling	86	Water Bottles & Carriers	259
Kayaks & Conoes	172	Water Polo	258
Lacrosse	224	Weights	96
Life Saving	171	Whistles	260
Line Marking	174	Winners Podiums	12
Long Jump	11	Yoga	259

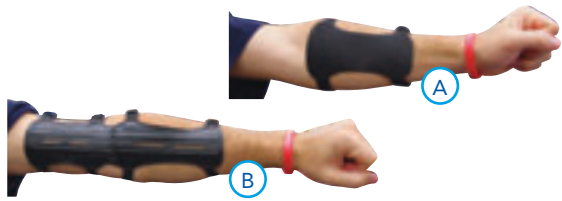

ARM GUARDS

Arm Guard with fully adjustable elasticised straps.

- 1001 A. Junior Arm Guard
- 1002 B. Senior Arm Guard
- 1003 Long Arm Guard

ARROWS

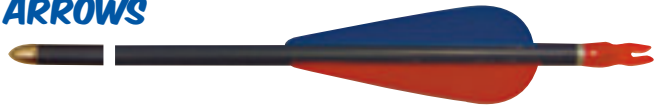

- 1010 Aluminium Set of 12 - 74cm

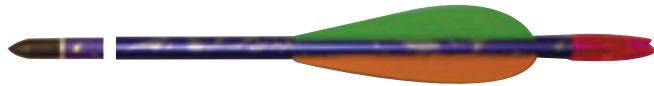

- 1011 Easton Jazz - Carbon Set of 12 - 71cm
- 1011X Easton Jazz - Carbon Set of 12 - 76cm



- 1020L Arrow Rest Left Handed Each
- 1020R Arrow Rest Right Handed Each

STRINGS



- 1030 60" String
- 1031 66" String
- 1032 93cm String
- 1033 112cm String
- 1034 130cm String



BUTTS & TARGETS

- 1040 A. Target Face 800mm x 800mm
- 1041 B. Target Face 1200mm x 1200mm
- 1042 C. Target Butt 1200mm x 1200mm

BOWS

- 1050 A. Bow 93cm
- 1051 B. Bow 112cm
- 1052 C. Bow 130cm
- 1053 Fibreglass 60"
- 1054 D. Target Take Down 66"

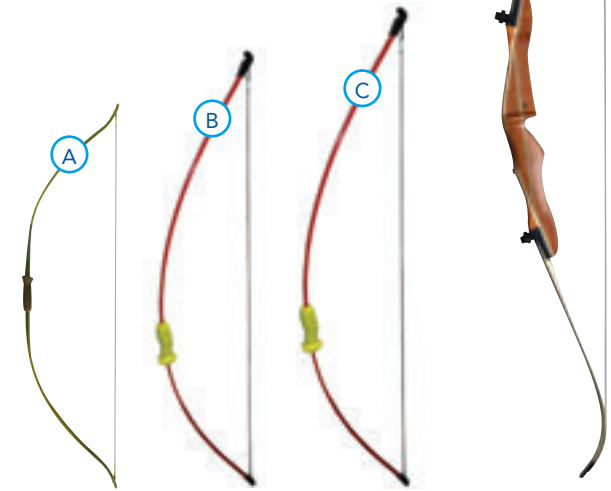

LEISURE BOW KIT 112CM - MEDIUM

- 112cm (44") Fibreglass bow kit
- Recurve Bow for kids recommended for Juniors up to 10 years old

Kit includes:

- 1 x 3 piece bow + String
- 2 x Wooden Arrows
- 1 x Arm Guard
- 1 x Quiver
- 1 x Target Mat (23cm x 23cm)

- 30001 Medium

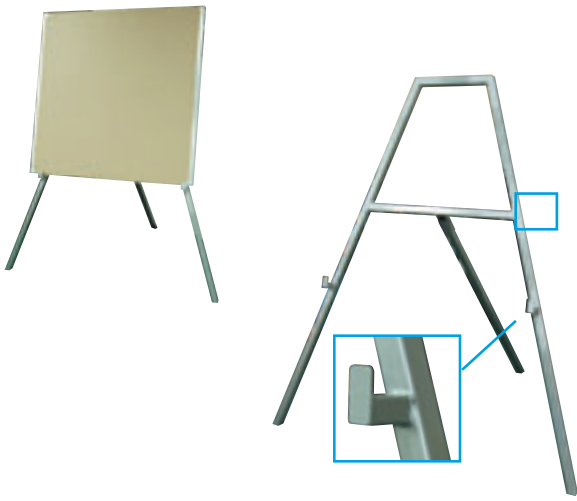

ARCHERY TARGET STAND

New and improved heavy duty archery stand, constructed from metal.

1070 Target Stand

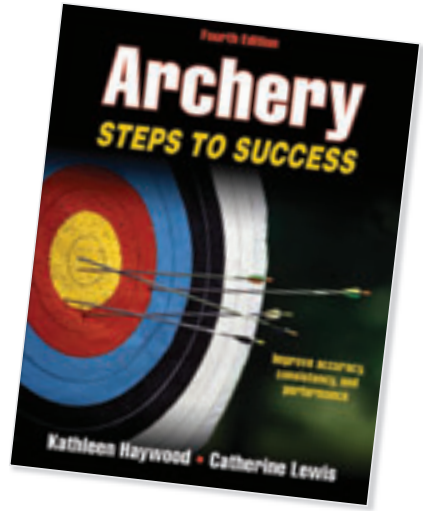

STEPS TO SUCCESS BOOK

2108 Steps to Success



FEATHER VANES

10903IN Feather Vane 3" **100 Pack**
 10904IN Feather Vane 4" **100 Pack**



FLETCH GLUE

1091 Fletch Glue



PLASTIC NOCKS

1092 Plastic Nocks **10 Pack**



FINGER TABS

1093 Finger Tab Leather



RUBBER DISCUS

Moulded rubber training discus ideal for schools & practice use. (Colours may vary)

1100	350g
1101	500g
1102	750g
1103	1kg
1104	1.5kg
1105	2kg



SYNTHETIC DISCUS

Alliance Synthetic Discus is perfect for the novice to intermediate thrower. The galvanized steel rim with durable ABS plates makes these discs last the distance. The Rim weight is 70%

1110	750g
1111	1kg
1112	1.5kg
1113	2kg



COMPETITION DISCUS

The Sportland IAAF approved Discus Synthetic is available in 4 different weights with a 85% rim weight. This discus is perfect for the high level thrower with durable ABS plates.

1121	1kg
1122	1.5kg
1123	1.75kg
1124	2kg



WOODEN DISCUS LOW SPIN - 70% RIM WEIGHT

Alliance Wooden Discus low spin - 70% Rim weight. Steel rim with solid laminated wooden sides.

ATDWLS1750	1750g
ATDWLS2000	2000g



WOODEN DISCUS

Alliance Wooden Discus conforms to WA specifications. Available in 4 different weights. Hollow wood side plates & high quality rims.

ATDW750	750g
ATDW1000	1000g
ATDW1500	1500g
ATDW1500	1750g
ATDW2000	2000g



ELEMENTARY SOFT PVC DISCUS

These Elementary Discus' are made from a single piece of soft PVC making them ideal for junior use.

They are colour coded for easy weight reference, with hi-visibility colours making them readily identifiable.

Specifications:
Suitable for indoor use
Colour coded by weight
Material: Soft PVC

ATDE200	200g	Red
ATDE350	350g	Green



MULTI THROW TRAINING DISCUS

Multi-Throw discus is an ultimate device for multi-sports throw training like Shotput Throw, Hammer Throw & Discus throw. It is made of soft PVC. Available in assorted colours and weights.

ATDMT400	400g
ATDMT600	600g
ATDMT800	800g



FOAM DISCUS

130mm Diameter with tough, durable outer coating.

1131	Foam 115g
------	-----------



SAFETY PRACTICE DISCUS

160mm Diameter.

1130	Safety 220g
------	-------------



DISCUS CARRY BAG

1175 Discus Carry Bag



SHOT PUT CARRY BAG

1176 Shot Put Carry Bag



SHOT PUT STOP BLOCK

An ideal way to set up a temporary shot put field anywhere on grass. Comes with spikes to fix in position. The curved steel band is 122cm long x 10cm high. The 3 spikes are 12cm long.

1192



METAL SHOT PUTS

1140	1kg
1141	1.5kg
1142	2kg
1143	3kg
1144	4kg
1145	5kg
1146	6kg



COMPETITION IRON SHOT PUT

- Machine rounded precision competition shot puts.
- Shot put diameter meet Little Athletics competition specifications.

ATSPC0.5	500g - 65mm Dia - Pink
ATSPC1	1kg - 80mm Dia - Navy Blue
ATSPC1.5	1.5kg - 80mm Dia - Yellow
ATSPC2	2kg - 80mm Dia - Orange



SHOT PUT ELEMENTARY SOFT

Take your indoor athletics to the next level with these Elementary Soft PVC Shot Puts. This solid shot put, made from PVC, provides a non-bounce and non-collapsible design for optimal performance. Designed for indoor athletics. Solid indoor shot with PVC cover. Non bounce and non squishy.

ATSPE200	200g
ATSPE400	400g
ATSPE600	600g

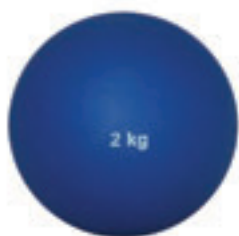

INDOOR SHOT PUT PVC NON BOUNCE

Solid indoor shot with PVC cover. Non bounce and non squishy.

1170	1kg
1171	2kg
1172	3kg



FOAM SHOT PUT

100mm Diameter with tough, durable outer coating.

1174 Foam 180g



SAFETY PRACTICE SHOT PUT

95mm Diameter.

1173 Safety 500g



TURNT SHOT PUT

TSP01	4kg - Red
TSP02	5kg - Bottle Green
TSP03	6kg - Sky Blue



ALLIANCE STARTING BLOCK TROLLEY

ALLIANCE Starting Block Trolley with heavy duty wheels that have a locking device to make it safe to use. This strong sturdy trolley can easily carry 10 starting blocks. Powder Coated Steel Cart

Red, Heavy Duty Wheels, 1180mm x 725mm x 1420mm, Weighs 20.4KG

SBT001



COMBO SHOT PUT & DISCUS TROLLEY

Solid heavy duty metal construction. Rubber tyres. Very easy to manoeuvre. 1.6m long approx.

1179



JAVELIN STORAGE TROLLEY

Javelin Storage Trolley with durable 15cm rubber wheels. Holds up to 18 Javelins and has a easy to turn swivel handle.

1355



ALL IN ONE ATHLETICS TROLLEY

1224



SHOT PUT TROLLEY

Durable 15cm rubber wheels. Easy to turn using handle. Holds 15 shot puts

1177



DISCUS TROLLEY

Solid heavy duty metal construction. Rubber tyres. Holds up to 36 discus and is very easy to manoeuvre. 1.4m long approximatly.

1178



IAAF APPROVED

TURNED IRON HAMMER THROW

Hammer throw sport involves a spherical metal ball of weight that is attached to a wire which is fastened to a handle. Hammer throw is a competitive sport for both Men & Women.

- 30010 3kg - 97mm (Blue)
- 30011 4kg - 102mm (Orange)
- 30012 5kg - 115mm (Yellow)
- 30014 6kg - 115mm (Red)



PORTABLE DISCUS CAGE

This fully portable cage can be used for discus and other sports and is a terrific cost effective answer to safety issues when you don't have permanent equipment. Supplied in easy to assemble kit form, it includes four galvanised steel bases, poles and net. Each pole is 3m long and the netting is 45mm square x 2mm thick mesh. PVC band edging around perimeter plus four eyelets on top band to slide over pole points. Total net size is 14m x 3m.

2457

Please allow 4-6 weeks for manufacturing.

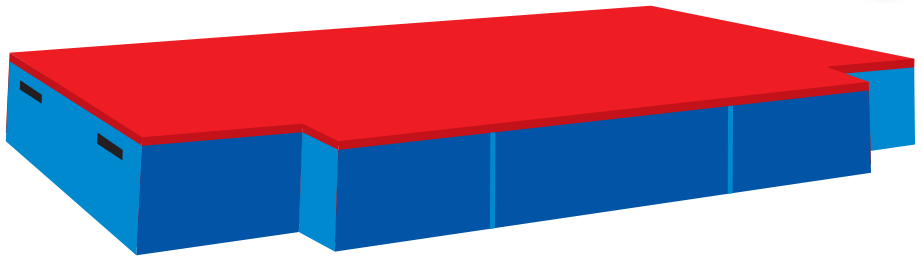
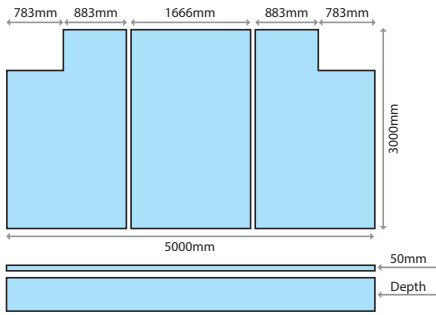

SG400 T-SHAPE HIGH JUMP MATS

Model: SG400
 Size: 5000mm (L) x 3000mm (W) x 500mm (D)
 Base Units: 3
 Wear Pad: 1
 Foam: Air Cell Centre with 3 grades of foam.

1200

SG450 T-SHAPE HIGH JUMP MATS

Model: SG450
 Size: 5000mm (L) x 3000mm (W) x 600mm (D)
 Base Units: 3
 Wear Pad: 1
 Foam: Air Cell Centre with 3 grades of foam.

1201

SG500 T-SHAPE HIGH JUMP MATS

Model: SG500
 Size: 5250mm (L) x 3000mm (W) x 700mm (D)
 Base Units: 3
 Wear Pad: 1
 Foam: Air Cell Centre with 3 grades of foam.

1223

SG820 BLOCK FOAM CENTRE HIGH JUMP MATS

Model: SG820
 Size: 5000mm (L) x 3000mm (W) x 500mm (D)
 Base Units: 3
 Cover: Box Type Cover
 Foam: Single High Density

1202

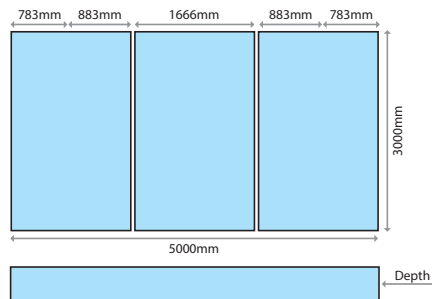

SG830 BLOCK FOAM CENTRE HIGH JUMP MATS

Model: SG830
 Size: 3600mm (L) x 2400mm (W) x 600mm (D)
 Base Units: 3
 Cover: Box Type Cover
 Foam: Single High Density

1203



LANDING BUN

1204 Landing Bun HD 1800 x 1200 x 500mm

LANDING BUN COVER

1208 Landing Bun Cover 1800mm x 1200mm x 500mm

LANDING BUN TOP MATS

- 1209 Landing Bun Top Mat with Foam 4 Bun - 500mm Deep
- 1210 Landing Bun Top Mat with Foam 3 Bun - 500mm Deep
- 1211 Landing Bun Top Mat shell no Foam 4 Bun - 500mm Deep
- 1212 Landing Bun Top Mat shell no Foam 3 Bun - 500mm Deep



SCISSOR MATS

Single Unit - Mesh or Vinyl Top

1205 Total mat size 2.5m x 2m x 150mm

Single Unit - Mesh or Vinyl Top

1206 Total mat size 3m x 2.5m x 150mm

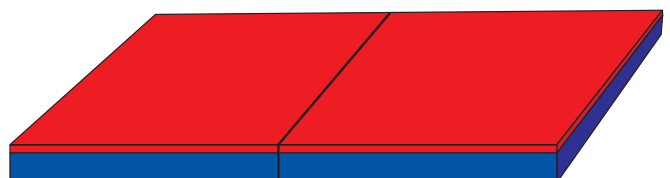

Double Unit - Mesh or Vinyl Top (Includes Velcro to Join)

1207 Total mat size 5m x 2m x 150mm

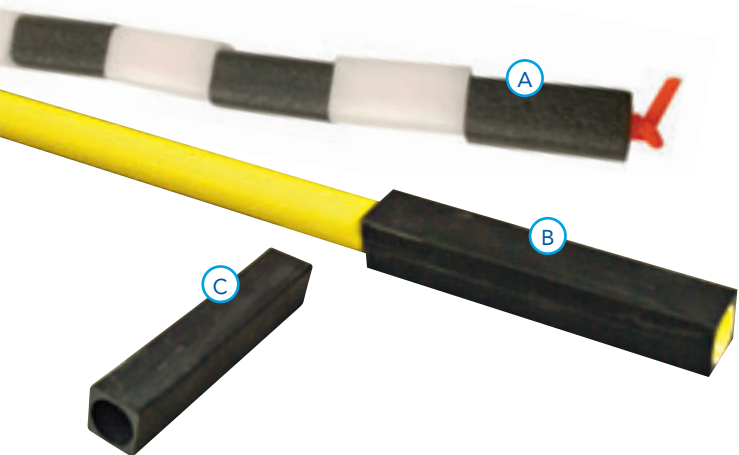

HIGH JUMP BARS

1214	A. Bar Elastic	
1215	B. Bar Fibreglass	
1216	C. Bar Ends	Pair



HIGH JUMP MAT TROLLEY

1213	For Landing Bun HD 1800 x 1200 x 457mm
------	--



HIGH JUMP STANDS GOLD SNR & JUNIOR

ATHJUG	Pair
CRAJ01 Cross Bar Rest Replacement	Pair



HIGH JUMP MEASURING STICK

1217

HIGH JUMP MEASURING TOOL

1217MT



SPARE CROSS BAR REST

1218	Pair
------	------

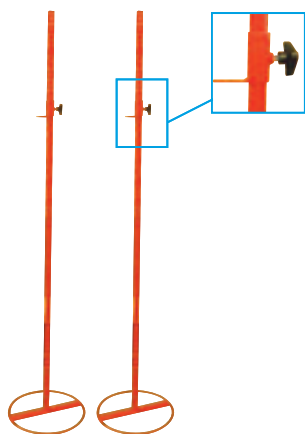

HIGH JUMP STANDS NO SPIKE

1220	Pair
1218S Cross Bar Rest Replacement	Pair



Lightweight aluminium uprights, cast aluminium crossbar platforms, uprights from 30cm to 210cm, 45cm square roll away steel base.

HIGH JUMP STANDS JNR IAAF REGULATION

1221	Pair
1218 Cross Bar Rest Replacement	Pair



HIGH JUMP STANDS DELUXE IAAF REGULATION 69-250CM

1222	Pair
1222R Cross Bar Rest Replacement	Pair

Please visit www.slatergartrellsports.com.au for up to date pricing.



FLAG BUNTING 30M

Bunting per 30m Length
(Contact us for custom colour combinations).

1254F	4 Colour Y, G, R & B
1254K	Solid Black
1254R	Solid Red
1254G	Solid Green
1254B	Solid Royal Blue
1254Y	Solid Yellow
1254W	Solid White
1254M	Solid Maroon
1254N	Solid Navy Blue



POST TREADIN FENCE POST

Ideal for temporary fencing and flag bunting.
Unique rugged foot design for ultimate durability.

TREADINSA023



BEAN BAGS

Colourful Vinyl or Nylon Beanbags

1252R	Vinyl Red
1252G	Vinyl Green
1252B	Vinyl Blue
1252Y	Vinyl Yellow
1253R	Nylon Red
1253G	Nylon Green
1253B	Nylon Blue
1253Y	Nylon Yellow

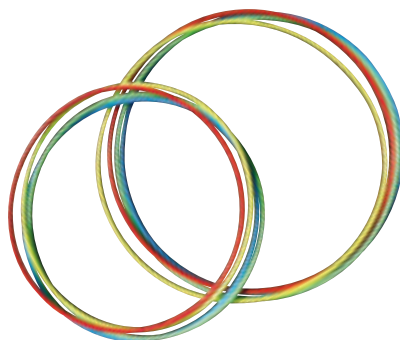

PLASTIC HOOPS

Available in 24" (61cm) or 30" (76cm)

1256R	24" Red
1256G	24" Green
1256B	24" Blue
1256Y	24" Yellow
1257R	30" Red
1257B	30" Blue
1257G	30" Green
1257Y	30" Yellow
1258R	24" Red (5 Pack)
1258B	24" Blue (5 Pack)
1258G	24" Green (5 Pack)
1258Y	24" Yellow (5 Pack)
1259R	30" Red (5 Pack)
1259B	30" Blue (5 Pack)
1259G	30" Green (5 Pack)
1259Y	30" Yellow (5 Pack)

HOLLOW PLASTIC HOOPS

Available in 24" (61cm) or 30" (76cm)

1267R	24" Red 61cm
1267G	24" Green 61cm
1267B	24" Blue 61cm
1267Y	24" Yellow 61cm
1268R	30" Red 76cm
1268B	30" Blue 76cm
1268G	30" Green 76cm
1268Y	30" Yellow 76cm
1269R	24" Red (5 Pack) 61cm
1269B	24" Blue (5 Pack) 61cm
1269G	24" Green (5 Pack) 61cm
1269Y	24" Yellow (5 Pack) 61cm
1270R	30" Red (5 Pack) 76cm
1270B	30" Blue (5 Pack) 76cm
1270G	30" Green (5 Pack) 76cm
1270Y	30" Yellow (5 Pack) 76cm



FLAT HOOPS

Available in 60cm or 75cm

SCHF6003	60cm - Red
SCHF6004	60cm - Blue
SCHF6006	60cm - Yellow
SCHF6011	60cm - Green
SCHF7503	75cm - Red
SCHF7504	75cm - Blue
SCHF7506	75cm - Yellow
SCHF7511	75cm - Green

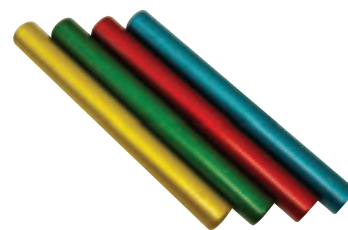

RELAY BATONS SETS

Lightweight anodised aluminium relay batons.
290mm length. Incl: 1 x Gold, Green, Red & Blue.

1250	Junior 32mm Diameter - Set of 4
1251	Senior 38mm Diameter - Set of 4



RELAY BATON SINGLE

Lightweight anodised aluminium relay baton.
290mm length.

1250JB	Junior Black
1250JR	Junior Red
1250JRB	Junior Royal
1250JY	Junior Yellow
1250JG	Junior Green
1250JBR	Junior Brown
1250JS	Junior Silver
1250JGD	Junior Gold
1251SB	Senior Black
1251SR	Senior Red
1251SRB	Senior Royal
1251SY	Senior Yellow
1251SG	Senior Green
1251SBR	Senior Brown
1251SS	Senior Silver
1251SGO	Senior Gold



LONG JUMP TAPE STAKE

1263 Each

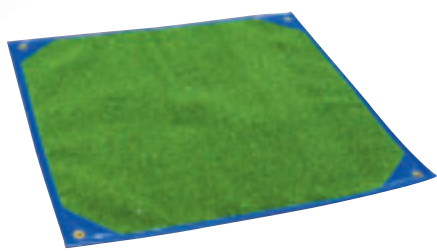

LONG JUMP TAKE OFF MAT SYNTHETIC TURF

1262 900mm x 900mm



LONG JUMP TAKE OFF MAT TWO TONE

1304 900mm x 300mm



BASE PEG

1264 Each



FIELD MARKER SET

Metal upright discs 9cm high, with black numbers 1-20 on one side only. Can be used for marking the start of the run up for long jump, high jump etc. or for any other temporary marking requirement.

1190 \$52.00



METAL ATHLETICS MARKERS

20 numbered athletic markers with carrier, constructed from hard wearing stainless steel.

1191 \$315.00



NUMBERED MARKING FLAGS 1-20

Numbered 1 to 20 on both sides and made from durable plastic approx 30cm high. Carry bag included.

44130



FLAG RACE FLAGS

Ideal for sports carnivals or classroom activities.

- 1255R Red Flag Each
- 1255G Green Flag Each
- 1255B Blue Flag Each
- 1255Y Yellow Flag Each
- 1255K Black Flag Each
- 1255W White Flag Each



MONARCH 4L METAL PAINT BUCKET

Ideal Bucket for Flag Race.

1661933



ATHLETICS SECTOR TAPE - 50M

Made from 50 MM wide polypropylene webbing
Ideal for marking athletic sectors, courts and field boundary lines.

Total length of tape: 50m
AST001 White



PATRICK CROWD CONTROL BARRIER - 100M

SPABCC100



ATHLETICS OFFICIALS FLAG

Officials flag for indicating variety of situations for different events. Flag is 40 cm x 40 cm and made of thick tetron cloth. Visible from long distances. Heavy duty plastic pipe with padded foam handle. Available in: White, Yellow & Red.

- AOF001 White
- AOF002 Yellow
- AOF003 Red



SG ALUMINIUM WINNERS DIAS PORTABLE WITH WHEELS

Constructed from Aluminium, this Portable Dias is easy to manoeuvre.

- 1261 3 Position Dias - 1, 2 & 3
- 1261X4 4 Position Dias - 1, 2, 3 & 4



LANE MARKER CONE SET 1 - 10

Set of 10 Lane Markers numbered 1-10 in White. Made from Fibreglass. Marker Size: Top: 430mm x 430mm. Base: 460mm x 460mm. Height: 46.5

LMC001

\$560.00



HART VICTORY PODIUM

Stand proud on the HART Victory Podium for all your awards and medal presentations. The durable podium is made of aluminium and powdercoated for First, Second and Third Places.

2-623 Set of 3



ALLIANCE WINNER STANDS

The ALLIANCE Winner Stands are a great way to celebrate your victories. The stands are constructed with durable fibreglass and features a rubber top to ensure stability and grip when you stand.

Specifications:

- Fibreglass stand with rubber top for grip
- Standing weight capacity: 150kg (per stand)
- Packing: 3 pieces can be inserted together and packaged in one box to save space.

ATAWS



ELECTRONIC STARTING GUN

- 3 in 1 sound functions: Starting pistol sound for Track & Field; Whistle for Team Sports and Siren for Swimming
- Support for Race Clock
- Can choose to signal start with LED light as well
- Included: 1 x electronic starting pistol, 1 x screw driver, 1 x communication cable for PA system usage
- Uses 3 x 1.5V AA Alkaline batteries
- Note: Batteries are NOT included in package
- The gun needs to plug into a speaker (3.5mm jack) Look at our range of compatible amplifiers in related products section
- Padded storage case included

1279



ELECTRONIC STARTING GUN WAIST AMPLIFIER 3.0

The Electronic Waist Gun Amplifier is used with the Alliance Electronic Starting Gun and features a great 15W volume output with Play, Stop, Rewind and Forward functions.

Specifications:

- 15 Watt output and volume control
- Includes a microphone headset
- Clip on belt mic for projection when starting device is not in use
- Built-in micro-SD for storage
- Built in rechargeable lithium battery lasts up to 4-7 hours when fully charged
- The Waistband Amplifier is a rechargeable amplifier which clips onto your belt for ultimate portability for events and sports carnivals
- Suitable for use with the Alliance Electronic Starting Gun
- Dimensions: 92mm (H) x 85mm (L) x 32mm (W)

ATSGEA3



ELECTRONIC STARTING GUN & ELECTRONIC STARTING GUN COMBO WAIST AMPLIFIER 3.0

1280



STARTING GUN ELECTRONIC PORTABLE AMPLIFIER

- Wireless – Plug starting gun into transmitter and then amplifier can be placed where needed
- Comes with microphone so announcements can also be made over amplifier
- To be used with electronic starting gun

12780



STARTING CLAP BOARD

12781



AIR HORN COMPLETE KIT STANDARD

Acoustic horn signal. Push button plastic top air horn. Includes aerosol can in kit.

- 30015 A. Air Horn Complete Kit
- 30016 B. Air Horn Refill Can
- 30017 C. Replacement Horn



EAR MUFFS

Block out the noise with these quality ear muffs.

1276



AIR HORN COMPLETE KIT DELUXE

Acoustic horn signal. Push button plastic top air horn. Includes 300ml aerosol can.

- 1274 A. Air Horn Complete Kit
- 1275 B. Air Horn Refill Can 300ml



AIR HORN PUMP ACTION

Pump action operation with high sound output.

1271



TUG-O-WAR ROPE

Heavy Duty Tug of War Rope 20m long. (2.5cm Dia)

- 126022 22 Metre
- 126030 30 Metre

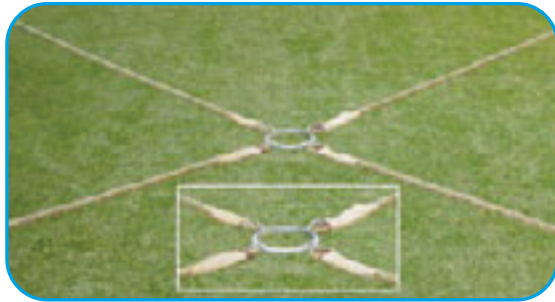

**TUG-O-WAR ROPE
JUTE 4 WAY**

Each rope is 5m Long.

12604W

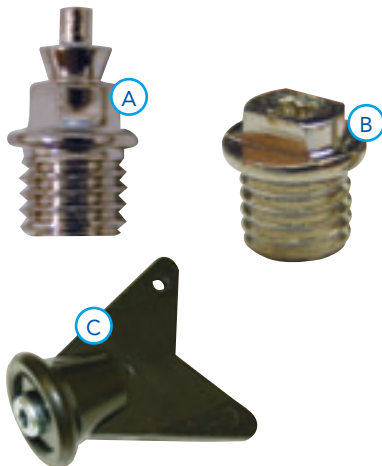

RUNNING SPIKES

- 1265 A. Christmas Tree 7mm 18 pack
- 1266 B. Running Spikes Blanks 12 pack
- 1267 C. Key for Spikes
- 1268 Running Spikes 5mm 12 pack
- 1269 Running Spikes 9mm 12 pack
- 1270 Running Spikes 12mm 12 pack



Charger: Fully automatic battery charger supplied, just connect and forget until the next time it is used.

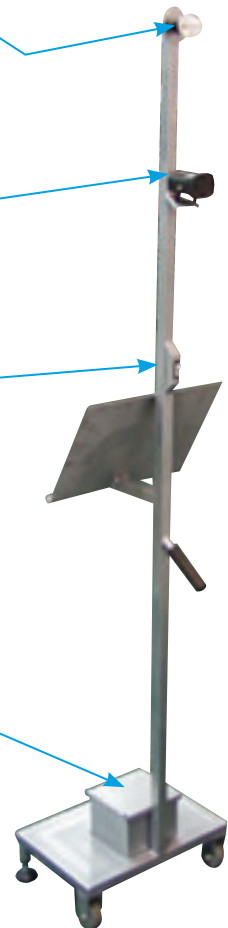

**PORTABLE STARTING
STAND AND LIGHT**

Constructed from steel, this heavy duty starting stand comes with a bright halogen light, loud 119DB piezo siren, 12V battery and charger, file holder and wheels making it easy to manoeuvre.

1284



**MASSIVE RANGE OF
RUNNING SPIKES
AVAILABLE.**

PLEASE CONTACT YOUR SALES REPRESENTATIVE FOR STYLES AND PRICING.



ALPHA STARTING BLOCKS

Made of slotted steel channel. Fixed PVC Plastic paddles with PVC pads.

1283A



DELUXE GREY STARTING BLOCKS V2

Made of slotted steel channel. Features lightweight aluminium paddles with grey PVC pads. Comes with spikes to hold the starting block on synthetic tracks.

1282

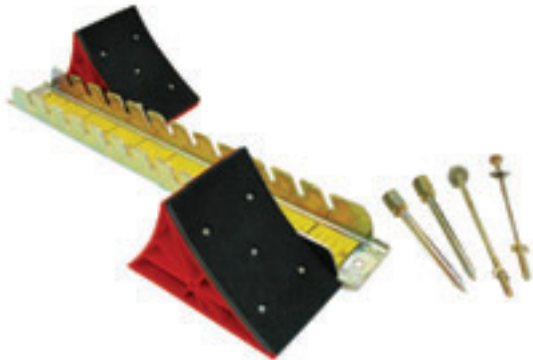

BETA STARTING BLOCKS

Made of slotted galvanized steel channel. Blocks made of extra thick polypropylene.

1283B



OLYMPIC STARTING BLOCKS

IAAF Approved. Centre rail made of 82 mm heavy slotted Aluminium Channel. Includes thick ribs to slip in anchor plates which ensures better ground stability. Extra broad paddles for an easy start.

1281

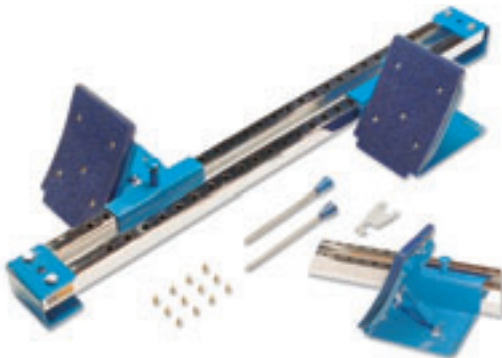

STANDARD STARTING BLOCKS

Made of double square steel tubes. M.S. steel paddles with PVC pads, both ends with spikes suitable for synthetic tracks.

1309



ALLIANCE STARTING BLOCK TROLLEY

ALLIANCE Starting Block Trolley with heavy duty wheels that have a locking device to make it safe to use. This strong sturdy trolley can easily carry 10 starting blocks. Powder Coated Steel Cart

Red, Heavy Duty Wheels, 1180mm x 725mm x 1420mm, Weighs 20.4KG

SBT001



PADDED SAFETY FOAM TOP HURDLE

Padded Foam Top Hurdle, Ideal for Training.

1285	Junior Size Hurdle
1286	Senior Size Hurdle



Senior Adjustable Heights:
76.2 cm, 84cm, 91.4cm,
99cm, 106.7cm

Junior Adjustable Heights:
45cm, 60cm, 68cm, 76.5cm

SG PVC BATON HURDLE

Timber Top Hurdle, Ideal for Training or Schools.

1287	Junior Size Hurdle
1288	Senior Size Hurdle
1289	Spare Baton PVC



SELF RETURN HURDLE

Lightweight aluminium tubular construction.
Self returns to upright position when pushed over.
Folds flat for easy storage.

Two sizes available: 76.2 cm wide (30") with
5 height adjustments from 40.64cm (16") to
60.96 (24") or 88.9 cm wide (35") with 7 height
adjustments from 66.04cm (26") to 106.68 (42")

1307	76.2 cm wide (30") 5 height adjustable.
1308	88.9 cm wide (35") 7 height adjustable.



SG CHAMPIONSHIP HURDLE

All Aluminium Construction. Adjustable to 5 different heights.

1290



STEP SPEED HURDLE

Durable light weight PVC Hurdles. Great training aid
for increasing foot speed, agility and lateral power.

3463	50cm High	Each
3462	45cm High	Each
3461	30cm High	Each
30050	23cm High	Each
3460	15cm High	Each

STEP SPEED HURDLE SETS SET OF SIX

Set of six durable light weight PVC Hurdles.

3472	45cm High x 6
3471	30cm High x 6



Collapsible for easy storage. 8 heights:
9", 18", 24", 27", 30",
33", 36", 39"

SG TRAINING HURDLE

Adjustable Height.

1295



COMPETITION HURDLE TROLLEY HOLDS 15 HURDLES

- Suitable for foldable style hurdles will fit Alliance Competition and Alliance Padded Hurdles
- Fits both Senior size and Junior size hurdles
- Made from heavy duty steel and powder coated red
- Features 4 heavy duty all surface wheels, back two wheels swivel making for easier maneuverability
- Sturdy handle for pulling and pushing the trolley, easily locks into bracket for storage
- Holds 15 hurdles - this can be increased with the purchase of the extender unit to 30 or 45

129710



COMPETITION HURDLE TROLLEY EXTENDER UNIT PLUS 15

- Extends Alliance Competition Trolley Base Unit to include more hurdles
- PLEASE NOTE – Extender unit can only be used in conjunction with Alliance Competition Trolley Base Unit, it can not be used by itself
- Suitable for foldable style hurdles will fit Alliance Competition and Alliance Padded Hurdles
- Fits both Senior size and Junior size hurdles
- Made from heavy duty steel and powder coated red
- Increase Hurdle Trolley capacity by 15 hurdles
- One base unit can be extended with the purchase of an extender unit for each extension, raising the capacity to 30 and then 45 hurdles

129720



HURDLE TROLLEY HOLDS 20 HURDLES

Note: This Trolley is suitable for Championship hurdle only.
1150mm (W) x 2550mm (L) x 1100mm (H)

129721



HURDLE TROLLEY HOLDS 40 HURDLES

Holds 40 Hurdles in total.
1150mm (W) x 2550mm (L) x 1100mm (H)

1296



TRAINING JAVELIN PLASTIC

Made of specially designed durable plastic with excellent straight shape. Soft tip for protection. Colour: Orange. Training javelins plastic are safe to use for practice indoor & outdoors. Ideal for learning proper throwing technique for junior athletes.

JTP01	300g - 70cm Long	Each
JTP02	400g - 70cm Long	Each
JTP03	500g - 112cm Long	Each
JTP04	600g - 112cm Long	Each

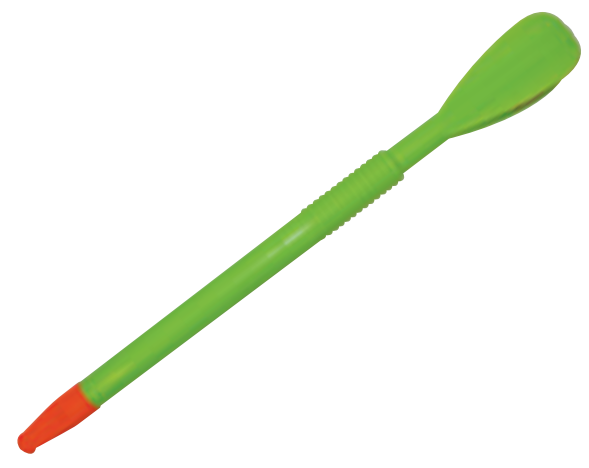

TURBOJAV PLASTIC

Made from strong polyurethane with a soft rubber safety tip, suitable for school children or training. Colour of javelin may vary.

1351	300g	Each
1352	400g	Each

Please visit www.slatertrellsports.com.au for up to date pricing.



JAVELIN STORAGE TROLLEY

Javelin Storage Trolley with durable 15cm rubber wheels. Holds up to 18 Javelins and has a easy to turn swivel handle.

1355



KNOCKEN BALL

Training aid for Javelin. Helps to develop the correct technique & grip.

2652	400g
2653	500g
2651	600g
2654	800g
2655	1000g



FOAM JAVELIN 83CM LONG

Discover the perfect tool for young athletes to master the art of javelin throwing with our Foam Javelin. Designed for safety, this lightweight EVA foam javelin features a vibrant tail for easy visibility and added excitement.

ATJF 83cm Long



TRAINING JAVELINS ALUMINIUM

1320	Training 400g
1321	Training 500g
1322	Training 600g
1323	Training 700g
1324	Training 800g

IAAF APPROVED

COMPETITION JAVELINS ALUMINIUM

1331	Comp 400g
1332	Comp 500g
1333	Comp 600g
1334	Comp 700g
1335	Comp 800g



Well balanced, quality aluminium javelins with cord grip and steel tip. Colour of javelin may vary.



JAVELIN HARD TUBE

Made from thick ABS plastic with heavy duty end caps for maximum protection. Shoulder strap for easy carrying. Adjusts to carry 600gm to 800gm javelins. Will hold approx 6 javelins. Length is adjustable from 2.3m to 2.9m.

2706



JAVELIN CARRY BAG

Made with durable nylon, reinforced ends, shoulder carry straps, velcro strip on opening strap, holds 5 javelins.

1350



FIBREGLASS MEASURING TAPE

Metric and Imperial Measurements.

1370	15 Metre
1371	30 Metre
1372	50 Metre
1373	100 Metre



FAST RETRACT MEASURING TAPE

Metric and Imperial Measurements.

1379	30 Metre
1380	50 Metre
1381	100 Metre

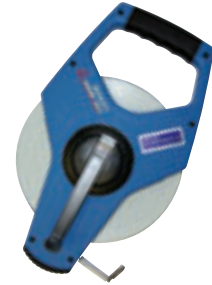

DELUXE MEASURING TAPE

Metric and Imperial Measurements.

1375	30 Metre
1376	50 Metre
1377	100 Metre



STEEL OPEN REEL MEASURING TAPE

Measuring tape made of steel. Unique open reel design.

ASO01	30 Metre
ASO02	50 Metre



STEEL CLOSED MEASURING TAPE

Metric and Imperial Measurements.

1382	10 Metre
1383	20 Metre
1384	50 Metre



SG MEASURING WHEEL

Precision engineering to the highest quality. Wheel diameter 318mm. Measure to 10,000m. Weight 1.53kg.

1391



TRI-FOLD MEASURING WHEEL

Precise and lightweight, trigger brake and counter control located on the handle. Easy to carry and store with the tri-fold feature. Hi-traction moulded PU tyre. Handy zip lock carry bag included. Measure up to 9,999.9 metres.

1392



STANDARD MEASURING WHEEL

Lufkin measuring wheels are calibrated for accuracy. The moulded rubber tyre resists corrosion while the tough plastic wheels withstand heavy use for a long service life. Large diameter wheel (315mm) for best accuracy on rough surfaces. Measure up to 9,999 metres. Curved telescopic handle. Made in Germany.

1393



DELUXE MEASURING WHEEL

M-10 Deluxe measuring wheel circumference is 1m. Clamp for wheel, Robust support allows M-10 to stand upright, Dirt remover, Precision counter, Sturdy spokes offer little resistance to wind ensuring ease of use, Highly visible red colouring. The M-10 is a high precision measuring tool and has been certified. Made in Germany.

1394



CAROL 6155 WITH SIREN MEGAPHONE

15w megaphone, includes siren and microphone. Requires 8 size C batteries (not included). Battery duration is approx 10 hours. Weight is 1.37 kg

1400



SG DELUXE MEGAPHONE RECOMMENDED

10w megaphone includes siren and microphone. Requires 8 size AA batteries (not included). Battery life is approx 10 hours. Weight without batteries 650g

1402



CAROL 625S WITH SIREN & MICROPHONE MEGAPHONE

25w megaphone, includes siren and hand held microphone. Requires 8 size C batteries (not included) or DC power. Battery duration is approx 6 hours. Weight is 1.27 kg inc microphone.

1401



SG DELUXE SPLASHPROOF MEGAPHONE

6w megaphone includes siren and microphone. Requires 6 size AA batteries (not included). Battery life is approx 8 hours. Weight without batteries 660g

1403



HANDHELD ADVENTURE 2-WAY RADIO UNIDEN UH615-2 TWIN PACK 1.5 WATT UHF

Introducing the latest in UHF Adventure 2-Way Radios from the world leaders in wireless communication. The UH615-2 is in a new smart and rugged proof design and a must for those that need to remain connected.

30022

ATHLETIC WEIGHT GUIDE

BOYS & GIRLS - AUSTRALIAN LITTLE ATHLETICS														
AGE	9 YEARS		10 YEARS		11 YEARS		12 YEARS		13 YEARS		14 YEARS		15 YEARS	
GENDER	Girl	Boy	Girl	Boy	Girl	Boy	Girl	Boy	Girl	Boy	Girl	Boy	Girl	Boy
SHOT PUT	2kg	2kg	2kg	2kg	2kg	2kg	2kg	3kg	3kg	3kg	3kg	3kg	3kg	4kg
DISCUS	500g	500g	500g	500g	750g	750g	750g	750g	750g	1kg	1kg	1kg	1kg	1kg
JAVELIN							400g	400g	400g	600g	400g	600g	500g	700g

MEN							
EVENT	OPEN	UNDER 20	UNDER 18	UNDER 17	UNDER 16	UNDER 15	UNDER 14
SHOT PUT	7.26kg	6kg	5kg	5kg	4kg	4kg	3kg
HAMMER THROW	7.26kg	6kg	5kg	5kg	4kg	4kg	NR
DISCUS	2kg	1.75kg	1.5kg	1.5kg	1kg	1kg	1kg
JAVELIN	800g	800g	700g	700g	700g	700g	600g

WOMEN							
EVENT	OPEN	UNDER 20	UNDER 18	UNDER 17	UNDER 16	UNDER 15	UNDER 14
SHOT PUT	4kg	4kg	4kg	4kg	4kg	4kg	3kg
HAMMER THROW	4kg	4kg	4kg	4kg	4kg	4kg	NR
DISCUS	1kg	1kg	1kg	1kg	1kg	1kg	1kg
JAVELIN	600g	600g	600g	600g	600g	600g	400g



UNIDEN UH820S-2 TWIN PACK HANDHELD 80 CHANNEL 2W UHF RADIO

This Uniden UH820S-2 UHF Radio Pack is perfect for staying connected if you're working in remote areas, hiking, on a construction site, or even in a large, commercial kitchen environment. The radios have a rugged design to withstand being used in Australian conditions and are ultra compact so you can easily keep them handy.

UH820S-2



PLACE RIBBONS
PVC 150MM X 35MM

14101	1st Place	Each
14102	2nd Place	Each
14103	3rd Place	Each
14104	4th Place	Each
30023	I Swam in a Race	Each
30024	I Ran in a Race	Each



PLACE RIBBONS
PVC 100MM X 29MM

14111	1st Place	Each
14112	2nd Place	Each
14113	3rd Place	Each
14114	4th Place	Each



PLACE RIBBONS
SATIN 150MM X 35MM

14121	1st Place	Each
14122	2nd Place	Each
14123	3rd Place	Each
14124	4th Place	Each
1412C	Custom*	Each

*\$100.00 Setup fee for custom ribbons.
Minimum order quantity is 100pcs



I'M A GOOD SPORT
PVC 100MM X 29MM

1413	Each
------	------



WELL DONE PVC

WD02	Each
------	------



I RAN IN A RACE PVC

1415	Each
------	------



I TOOK PART IN AN EVENT PVC

1416	Each
------	------



SUPER EFFORT SATIN

1417	Each
------	------



I'M A GOOD SPORT SATIN

1418	Each
------	------



I TOOK PART IN AN EVENT SATIN

1419	Each
------	------



BRASS PINS

19mm long brass pins. (100pcs)

1430	Each
------	------



PLACE CARDS PADS
80MM X 80MM

14351	1st Place	50 Per Pad
14352	2nd Place	50 Per Pad
14353	3rd Place	50 Per Pad
14354	4th Place	50 Per Pad



I RAN IN A RACE MOUSE

1450 54 Pack



I RAN IN A RACE DINOSAUR

1451 54 Pack



I DID MY BEST KANGAROO

1452 54 Pack



I'M A SUPER RUNNER

1453 54 Pack



I SWAM IN A RACE

IS001 50 Pack



SUPER RUNNER

1467 54 Pack



SMILEY FACE

1456 100 Pack



GREAT TEAM EFFORT

1463 54 Pack



I RAN IN A RACE TURTLE

1458 54 Pack



SUPPER EFFORT FROG

1459 54 Pack



FANTASTIC EFFORT

1465 50 Pack



WELL DONE ROBOT

WD01 50 Pack



I'M A GOOD SPORT

1469 54 Pack



FANTASTIC EFFORT

SS01 54 Pack



TERRIFIC EFFORT

SS02 54 Pack



GREAT TEAM EFFORT

SS03 54 Pack



WELL DONE

SS04 54 Pack



GOOD SPORT

SS05 54 Pack



I'M A GOOD SPORT

SS06 54 Pack



I RAN IN A RACE MOUSE

SS07 54 Pack



I'M A SUPER RUNNER

SS08 54 Pack



1ST PLACE CHROME

SS12 108 Pack



2ND PLACE CHROME

SS13 108 Pack



3RD PLACE CHROME

SS14 108 Pack



4TH PLACE CHROME

SS15 108 Pack



1ST PLACE

1470 80 Box



2ND PLACE

1471 80 Box



3RD PLACE

1472 80 Box



GOLD AWARD

1474 100 Box



SILVER AWARD

1475 100 Box



BRONZE AWARD

1476 100 Box



FIRST MEDAL

1477 80 Box



SECOND MEDAL

1478 80 Box



THIRD MEDAL

1479 80 Box



FOURTH MEDAL

1480 80 Box



DELUXE 3D MEDALLION WITH RIBBON

Includes: Engraving, Sport & Ribbon Colour.

- 1500 Gold
- 1501 Silver
- 1502 Bronze



PLACE STICKERS BURST

- SS09 1st - 82 Pack
- SS10 2nd - 82 Pack
- SS11 3rd - 82 Pack
- SS12 4th - 82 Pack



BASIC MEDALLION WITH RIBBON

Includes: Engraving, Sport & Ribbon Colour.

- 1510 Gold
- 1511 Silver
- 1512 Bronze

Please allow 7-10 days for despatch of Medallions and Trophies.



DELUXE TROPHY WIN OR PLACE

Includes: Engraving and choice of Sport.
Available in Colours: Blue, Red, Green, Black, Gold, Silver.

- 1530 Deluxe Trophy Win
- 1531 Deluxe Trophy Place

BASIC TROPHY WIN OR PLACE

Includes: Engraving and choice of Sport.
Available in Colours: Blue, Red, Green, Black, Gold, Silver.

- 1520 Basic Trophy Win
- 1521 Basic Trophy Place



TOP QUALITY
SHUTTLES



WISH®

YOUR RACQUET SPORT SPECIALIST



Racquets for all school /
club needs

Entry level Alumtec range
to teach you the basics

Intermediate Fusiontec
range for durability,
control and skill
development



WISH JUNIOR 613 22" BADMINTON RACQUET

Frame Composition – Aluminium. Shaft Composition – Steel. Weight – U/95–99.9g. Grip Size – G3. String Tension – 18–20lbs. Length – 585mm. Includes Cover

1600



WISH ALUMTEC 650 BADMINTON RACQUET

Frame Composition – Aluminium. Shaft Composition – Steel. Weight – 2L/105–109.9g. Grip Size – G3. String Tension – 18–20lbs. Length: 665mm. Includes Cover

1601



WISH ALUMTEC 780 BADMINTON RACQUET

Frame Composition – Aluminium. Shaft Composition – Steel. Weight – 2L/105–109.9g. Grip Size – G3. String Tension – 18–20lbs. Length: 665mm. Includes Cover

W780



WISH FUSIONTEC 970 BADMINTON RACQUET

Frame Composition – Aluminium. Shaft Composition – Graphite. 1 piece racquet using Wish's fusion technology. Weight – 2L/95–99.9g. Grip Size – G3. String Tension – 18–22lbs. Length – 665mm. Includes Cover

1606



YONEX SG340 BADMINTON RACQUET

The Yonex SG340 Badminton Racquet is built with an alloy frame and a steel shaft to offer a sturdy racquet for beginners. The large head is designed to offer more precise shots to allow you to up your game.

30026



YONEX SG MUSCLE PI BADMINTON RACQUET

The Yonex Muscle Power 1 Badminton Racket is a great starter racket for recreational use. This racket has a balanced racket balance and has a stiff flex allowing for control. This racket weighs in at 93 grams and makes for a great beginner racket.

30027



CARLTON 4.3 BADMINTON RACQUET

1604



CARLTON AERO BLADE 2000 WIDE BODY BADMINTON RACQUET

1603



WISH BADMINTON SET OF 4 - PLAYER 5566

ALUMTEC is constructed with premium grade aluminium alloy, a high-performance metallic material widely used in the aviation industry that provides a lightweight and durable design. ALUMTEC is ideal for beginners.

- Set includes:
- 4 x Wish Alumtec 5566 badminton racquets
 - Set of 3 nylon shuttlecocks
 - Metal posts, badminton net, tiedown cord and pegs for the net system
 - Line marking straps
 - Carry bag with handle and shoulder strap for easy storage and portability

30025



WISH RACQUET HOLDER

Portable storage rack for badminton, tennis and squash racquets. Lightweight, sturdy durable PVC coated metal frame has adjustable side strap for added stability. Holds up to 28 racquets. Some assembly required.

1630



CARLTON CLUB MATCH NYLON BADMINTON SHUTTLES

1611 Dozen



CARLTON INTERNATIONAL NYLON BADMINTON SHUTTLES

1612 Dozen



AIRFLOW 5000 NYLON BADMINTON SHUTTLES

A5001	Medium Speed	Dozen
A5002	Fast Speed	Dozen



AIRFLOW 6000 NYLON BADMINTON SHUTTLES

A6001	Medium Speed	Dozen
A6002	Fast Speed	Dozen



WISH NYLON SHUTTLE YELLOW - MEDIUM SPEED - BLUE TAPE

Physical Education quality cork head and durable nylon for better control in the air.
Also suitable for leisure use by families for outdoor shuttlecock.

AF8000 Dozen



DUCK FEATHER TRAINING BADMINTON SHUTTLES

1622 Dozen



SG CLUB COMPETITION FEATHER BADMINTON SHUTTLES

1621 Dozen



GOOSE FEATHER MATCH BADMINTON SHUTTLES

1623 Dozen



BADMINTON NETS

6 Meters in Length.

1651	Lightweight Club Nylon Rope
1652	Competition Nylon Rope
1653	Tournament Nylon Rope

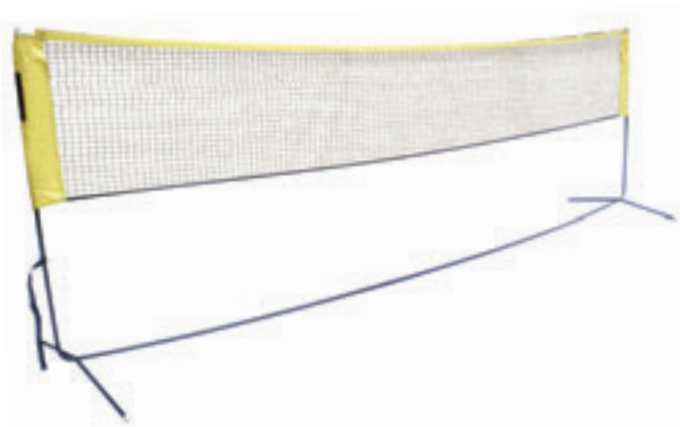

**WISH BADMINTON MINI NET SYSTEM
5 METER**

- Size: 5m long x 85cm high
- Steel poles – diameter 19.1mm (3/4")
- Polyester net
- Comes in nylon carry bag with shoulder straps for easy portability and storage

BDWMNS

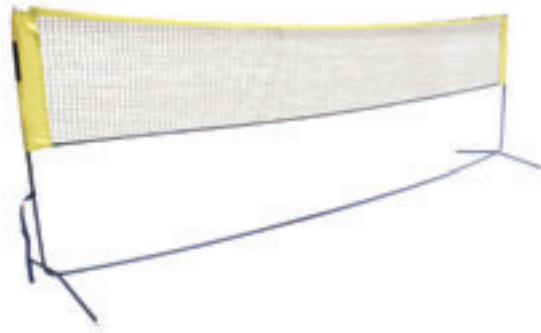

**WISH BADMINTON MINI NET SYSTEM
3 METER**

- Size: 3m long x 85cm high
- Steel poles – diameter 19.1mm (3/4")
- Polyester net
- Comes in nylon carry bag with shoulder straps for easy portability and storage

WMTN01



**ALLIANCE BADMINTON
PORTABLE NET SYSTEM
3 METRE**

Play badminton wherever you are with this portable badminton net system. Comes in a nylon carry bag with shoulder straps for easy portability and storage.

The Mini Net System is held together with 19.1mm diameter steel poles and the net is made from polyester.

This net system is a great solution for schools without permanent courts.

Specifications:

- Polyester Net
- Nylon carry bag with shoulder straps
- Great solution for those without permanent courts

Size:

- Length x Height - 300cm x 155cm
- Steel Pole Diameter - 19.1mm

BDANPS3



**PORTABLE BADMINTON NET
3 METER**

Fully adjustable height with bag.

1640

ACROMAT

ACROMAT

SLATER-GARTRELL SPORTS WA AGENT

Acromat is now recognised as a world leader in gymnastic and sporting equipment, with the Acromat's performance finely tuned to match the high expectations of athletes at all levels of competition. To ensure the needs of gymnasts and athletes are met, especially in the critical areas of engineering strength and safety, we design much of our equipment in close consultation with leading coaches.

Please forward all enquiries to: sales@slatertrellsports.com.au



PORTABLE BADMINTON STANDS

Weighted heavy duty base with swivel wheels.

Note: The bases can also be used for Volleyball. (Volleyball posts will need to be purchased).

1660	A. P/Stands Badminton	Pair
1662	B. Portable Bases Only	Pair
1663	1 x Spare Base	Each
1665	Badminton Posts Only	Pair



ALL IN ONE STAND DELUXE

- 3 section design
- Suitable for Badminton, Tennis, Volleyball and Netball
- Each stand adjustable in height from 165cm to 305 cm
- Heavy duty square steel tubes for greater durability
- Pole (square =) 50mm
- Steel base frame for adding PORTABLE STAND WEIGHTS - 25KG to stabilise stand
- 25KG Portable weights sold separately (see: NBPSW25 - PORTABLE STAND WEIGHT 25 KG)
- Each stand frame can accommodate 4 x PORTABLE STAND WEIGHTS - 25KG adding a total weight of 200KG to the set
- 100mm wheels make moving easier
- Quick assembly
- Top attachment for volleyball net
- Ring attachment for Netball

100076



PORTABLE STAND WEIGHT 25KG

- Portable steel weight with carry handles
- 25kg per weight
- Used with ALLIANCE DELUXE STANDS

100077

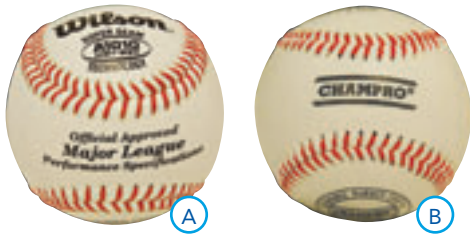

BASEBALLS

- 1700 A. Top Grade Baseball Leather
 1701 B. Synthetic Leather



T-BALLS

- 1710 A. Incrediball T-Ball, Baseball
 1711 B. Incrediball T-Ball, Baseball Easton
 1712 C. Cork Center T-Ball
 1713F D. 9" PU Foam



SOFTBALLS

- 1720 A. SG Safety 11"
 1721 B. SG Safety 12"
 1724 C. Foam (Roo Ball)
 1722 D. Synthetic Leather 12"
 1727 E. Easton Safety Ball 11"
 1725 F. Easton Safety Ball 12"
 1726 G. Wilson Fluro 11"
 1723 H. Wilson Fluro 12"
 1728 I. Wiffle Ball 12"



BASES T-BALL

- 1730 A. T-Ball Bases Nylon - Set of 3
 1731 B. Nylon Single Base
 1732 C. Safety Base T-Ball
 1733 D. Throw Down Bases Rubber - Full Set

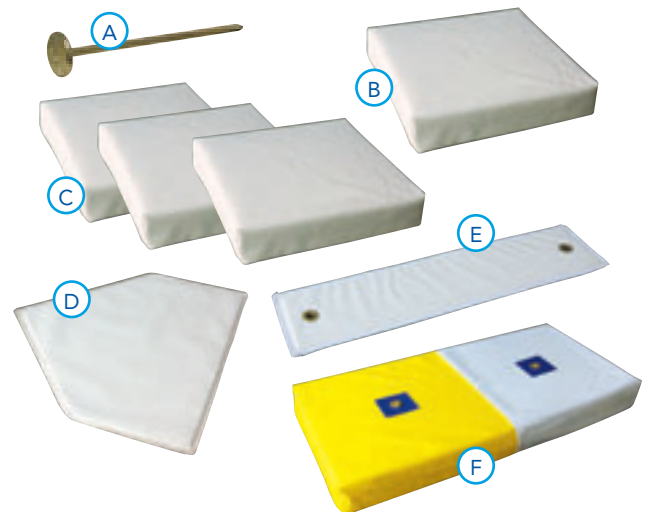

BASES SOFTBALL

- 1264 A. Base Pegs
 1741 B. Base Single Softball
 1742 C. Softball Bases Nylon - Set of 3
 1743 D. Home Plate
 1744 E. Pitchers Plate
 1745 F. Safety Base Softball



SOFTBALL EASTON / LOUISVILLE 28"-34"

BASEBALL LOUISVILLE / EASTON 29-34"

T-BALL WOODEN 24", 26", 28", 30"

T-BALL ALUMINIUM 24, 26, 28"

BASEBALL LOUISVILLE 26-31" LITTLE LEAGUE

Barrel size as per Softball

BAT SIZING GUIDE

AGE	BAT LENGTH
5-7	24" - 28"
8-9	27" - 29"
10	28" - 30"
11-12	30" - 31"
13-14	31" - 32"
15+	33" - 34"

BASEBALL, SOFTBALL & T-BALL BATS

175028	Softball Easton Louisville 28"
175029	Softball Easton Louisville 29"
175030	Softball Easton Louisville 30"
175031	Softball Easton Louisville 31"
175032	Softball Easton Louisville 32"
175033	Softball Easton Louisville 33"
175034	Softball Easton Louisville 34"
175126	Baseball Easton Louisville LL 26"
175127	Baseball Easton Louisville LL 27"
175128	Baseball Easton Louisville LL 28"
175129	Baseball Easton Louisville LL 29"
175130	Baseball Easton Louisville LL 30"
175131	Baseball Easton Louisville LL 31"
175229	Baseball Easton Louisville 29"
175230	Baseball Easton Louisville 30"
175231	Baseball Easton Louisville 31"
175232	Baseball Easton Louisville 32"
175233	Baseball Easton Louisville 33"
175234	Baseball Easton Louisville 34"
176024	T-Ball Wooden 24"
176026	T-Ball Wooden 26"
176028	T-Ball Wooden 28"
176030	T-Ball Wooden 30"
176124	T-Ball Aluminium 24"
176126	T-Ball Aluminium 26"
176128	T-Ball Aluminium 28"



BASEBALL & SOFTBALL GLOVES

1780LHT	PVC 9.5" LHT
1780RHT	PVC 9.5" RHT
1781LHT	PVC 10.5" LHT
1781RHT	PVC 10.5" RHT
1782LHT	Leather Synthetic 11" LHT
1782RHT	Leather Synthetic 11" RHT
1783LHT	Leather Synthetic 12" LHT
1783RHT	Leather Synthetic 12" RHT
1784LHT	Leather Synthetic 13" LHT
1784RHT	Leather Synthetic 13" RHT

RHT - Right hand throw glove, the glove is placed on the left hand for a right handed thrower.

LHT - Left hand throw glove, the glove is placed on the right hand for a left handed thrower.



SG BASEBALL & SOFTBALL GLOVE

1785LHT	Leather 12" LHT
1785RHT	Leather 12" RHT
1786 LHT	Leather 13" LHT
1786 RHT	Leather 13" RHT



FIRST BASE MITT SNR & JNR

1791	
------	--



CATCHERS MITT BASEBALL

1790	
------	--



CATCHERS MITT SOFTBALL

1792	
------	--



STANDARD KIT INCLUDES:

- 9 x Fielders Gloves, 4 x Batting Helmets,
- 2 x Aluminium Quality Bats, 1 x Vinyl Safety Base,
- 2 x Vinyl Bases, 1 x Vinyl Home Plate, 1 x Vinyl Pitchers Strip,
- 6 x T-Balls, 1 x Heavy Duty adjustable T-Ball Stand,
- 1 x Heavy Duty Gear Bag

T-BALL COMPLETE KIT

1860 T-Ball Kit

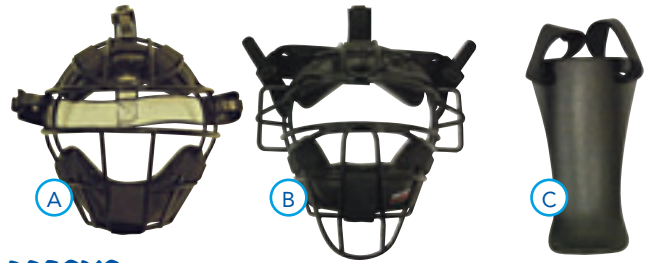

MASKS

- 1830 A. Junior Mask (Square)
- 1831 Senior Mask (Round)
- 1835 C. Throat Protector Velcro Style



LEG GUARDS

- 1820 Junior Double Action
- 1821 Senior Double Action
- 1822 Leg Guard Strap (Set of 6)



DELUXE KIT INCLUDES:

- 8 x Fielders Gloves, 1 x Leather First Base Mitt,
- 4 x Batting Helmets, 1 x Catchers Helmet & Mask,
- 1 x Chest Protector, 1 x Throat Protector,
- 1 x Pair Deluxe Leg Guards, 2 x Aluminium Quality Bats,
- 1 x Vinyl Safety Base, 2 x Vinyl Bases,
- 1 x Vinyl Home Base, 1 x Vinyl Pitchers Strip, 6 x Softballs,
- 1 x 4-Way Counter, 1 x Scorebook, 1 x Heavy Duty Gear Bag

SOFTBALL COMPLETE KITS DELUXE

1870 Softball Kit Deluxe Senior 13" Gloves
 1871 Softball Kit Deluxe Junior 12" Gloves



SOFTBALL, T-BALL & BASEBALL HELMETS

- 1800 A. Softball, T-Ball Batter
- 1814 Helmet Strap
- 1812 B. Helmet Mask & Catcher
- 1813 C. Helmet Baseball Batter



CHEST PLATES

- 1770 Chest Plate SG Large
- 1771 Chest Plate SG Medium
- 1772 Chest Plate SG Small



CHAMPRO GLOVE LACING KIT

Have your glove laces worn out? Need a replacement? Look no further than the Champro Glove Lacing Kit.

Including a 48" (121.92cm) genuine tan rawhide lace and a steel lacing tool, get your gloves back in playing condition with this super handy kit.

BACAGLK



CHAMPRO BASEBALL UMPIRE COUNTER METAL

The Champro Baseball Metal Umpire Counter is a high-quality accessory that helps any umpire get the job done.

Includes four dials in a traditional layout to keep track of strikes, balls, outs, and innings. It's also constructed with steel to maximize durability and is designed to last for seasons.

BACAUCM



9" BALL CAGE - HOLDS 24

The ALLIANCE Ball Cage is the perfect solution for storing & carrying your hockey, cricket, baseballs & teeballs. Holds up to 24 x 9" balls.

Strong tensile steel powder coated frame.

- Holds 24 x 9" Balls
- Suitable for hockey balls, cricket balls, baseballs, teeballs
- High-tensile steel powder coated fram

HKAC24



9" RUBBER SPONGE CENTRE TETHER TEEBALL CHAMPRO

The Champro Rubber Tether T-ball is a fun way to practice your swings where the ball doesn't ever get too far away.

The t-ball is affixed to a long elastic tether cord to bring the ball back in range after being hit, so you don't spend the entire time chasing the ball.

The ball features a soft sponge core making it ideal to help teach young players the game.

Specifications

- Moulded rubber cover with raised "stitched" seams
- Sponge centre for safety
- Long elastic tether cord allowing the ball to rebound back towards the hitter without getting too far away
- Attaches easily to t-ball batting stands
- Size: 9" diameter (22.86cm)

1714



SHOE GOO - ORIGINAL

The Sof Sole Shoe Goo is stronger, and more durable than your standard glue formula. Suitable for rubber, leather, canvas and vinyl. For best results, ensure the area is cleaned and dry before application. The Shoe Goo will bind instantly, and can take between 2 - 3 days to dry completely.

1851



REGENT SOFTBALL/ BASEBALL SCORE BOOK

Keep control of the game with the Regent Score Book.

1850



**T-BALL STAND
HEAVY DUTY RUBBER**

- 1842 Heavy Duty Rubber T-Ball Stand Complete
- 1843 Replacement Rubber Top HD



**T-BALL STAND
FOLDING RELIANCE**

- 1844 Folding Stand Reliance Complete
- 1844T Replacement Yellow Top



**DUO-LINE GRIP
13 METER ROLL
STELLA**

Size: 1300mm x 24mm x 1.6mm.

- 1853 Black
- 1853N Navy
- 1853Y Yellow



**REPLACEMENT RUBBER
TOP HEAVY DUTY**

- 1843 Replacement Rubber Top HD



**REPLACEMENT TOP
RELIANCE FOLDING**

- 1844T Replacement Yellow Top



**REPLACEMENT RUBBER
JOINER RELIANCE FOLDING**

- 1844M Replacement Rubber Joiner

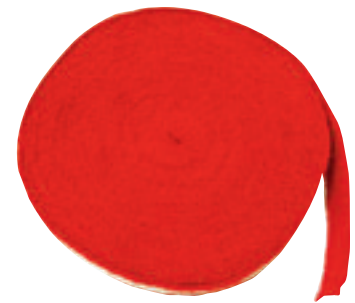

**TOWELLING GRIP
12 METER ROLL
WISH**

Keep a dry, firm grip on your racket, through all moisture conditions. This is a towel grip made of 100% cotton. It has improved absorbency for sweat, rain, or other types of moisture conditions, and adds an additional to your racket handle for comfort.

- 1852 Black
- 1852W White
- 1852R Red
- 1852N Navy
- 1852A Aqua



BASKETBALL SIZING GUIDE

AGE	BALL SIZE
Under 7 Years	Size 3
7 - 9 Years	Size 5
10 - 14 Years Male	Size 6
10 - Open Female	Size 6
15 Years to Open Male	Size 7



RUBBER COLOURED BASKETBALLS BADEN

Durable rubber cover for consistent performance and a deep channel design for increased grip and control.

19003R	Size: 3 - Red
19003B	Size: 3 - Blue
19003Y	Size: 3 - Yellow
19003G	Size: 3 - Green
19003O	Size: 3 - Orange
19005R	Size: 5 - Red
19005B	Size: 5 - Blue
19005Y	Size: 5 - Yellow
19005G	Size: 5 - Green
19005O	Size: 5 - Orange
19006R	Size: 6 - Red
19006B	Size: 6 - Blue
19006Y	Size: 6 - Yellow
19006G	Size: 6 - Green
19006O	Size: 6 - Orange
19007R	Size: 7 - Red
19007B	Size: 7 - Blue
19007Y	Size: 7 - Yellow
19007G	Size: 7 - Green
19007O	Size: 7 - Orange



WILSON MVP PERFORMANCE RUBBER

Practice shooting some hoops with the Wilson MVP Basketball, perfect for recreational outdoor play, constructed from performance rubber which gives a great level of durability and performance. The basketball is complete with Wilson branding and an MVP logo to give it the finished look.

19025	Sizes: 5
19026	Sizes: 6
19027	Sizes: 7



WILSON LEGEND COMPOSITE LEATHER

When you start out, you're gonna spend a lot of hours on a court. Which is why the NCAA Street Shot combines premium construction, durability and performance to withstand not just games, but days, spent at the playground.

19045	Sizes: 5
19046	Sizes: 6
19047	Sizes: 7



WILSON SHOWCASE INDOOR/OUTDOOR

High performance composite unrivaled grip and control. Laid in channels 100% composite cover. Cushion core™ carcass maximum softness and grip. Pressure lock bladder locks in air to maintain optimal ball pressure.

19056	Sizes: 6
19057	Sizes: 7



WILSON NXT GAME BALL

The new Official Game Ball of the NBL (Size 7 - Indoor use) is a Wilson designed Solution Game Ball. The Solution Ball is currently the Official ball of the NCAA Championships and NCAA March Madness.

The ball sets the standards for innovation and performance on the court.

Patented features include the only moisture absorbing cover in the market and laid in channels, creating a 100 per cent composite cover.

19067	Sizes: 7
-------	----------



SPALDING TF-250 COMPOSITE LEATHER

This Spalding TF-250 Indoor/Outdoor Basketball is made with Spalding's exclusive all surface composite cover material. Featuring a wide-channel design, it provides superior performance in any setting.

190785	Sizes: 5
190786	Sizes: 6
190787	Sizes: 7



SPALDING TF-1000

Spalding TF-1000 Basketball is regulation size (29.5") for official play and is also approved by NFHS making it the right choice for your basketball programs. This basketball is constructed of exclusive ZK composite leather, which provides excellent moisture management ensuring superior grip all game long. The wide channel design also makes gripping easier. Designed for use on indoor courts only.

190776	Sizes: 6
190777	Sizes: 7



SPALDING TF-GRIND

The TF-Grind is the perfect all-rounder ball. Suitable for all playing surfaces, the Spalding TF-Grind Basketball Australia ball is ideal for shooting hoops in your yard or playing a game with friends at the local court.

- Material - PU composite leather
- Designed for both indoor and outdoor play

30029	Sizes: 5
19156	Sizes: 6
100055	Sizes: 7



**MOLTEN BG5000
PREMIUM GRAIN LEATHER**

BG5000 takes full advantage of the natural leather properties to ensure better texture. All lettering design on the BG5000 is branded into the ball to offer an authentic look to the natural leather basketball.

MBG01 Sizes: 5

MBG02 Sizes: 6

MBG03 Sizes: 7



**BADEN BASKETBALL
CROSSOVER**

Flex Composite Cover for ALL SURFACE indoor/ outdoor play. Badens widely-spaced, symmetrical panels ensure better consistency

BBC01 Sizes: 5 Orange

BBC02 Sizes: 6 Orange

BBC03 Sizes: 7 Orange

BBC06 Sizes: 7 Neon Green Black

BBC09 Sizes: 7 Neon Orange Black



COACHING BASKETBALL

Improve your shooting form with a "hands on" approach by learning how to correctly place your hands on the ball. Great training aid can be used for left or right handed shooters. Bright yellow ball is easy to identify for coaches.

4179 Size: 3

4178 Size: 5

4177 Size: 6



**MOLTEN BG3200
COMPOSITE LEATHER**

The Molten BG3200 Basketball is a 12 panel design made with premium composite leather. Parallel pebble technology enhances grip and feel, while the durable butyl bladder delivers great air retention. It's the official weight and size for a game ball.

19125 Sizes: 5

19126 Sizes: 6

19127 Sizes: 7

**D-MAN
HANDS-UP DEFENSIVE
MANNEQUIN**

D-Man, the portable hands-up defensive mannequin, is the perfect practice partner. Learn to shoot or pass over or around the hands-up defending position. Use multiple D-Men to practice dribbling, driving and positioning with a defender. Ideal for solo practice or team settings.

D-Man Features

- Learn to shoot or pass over or around the hands-up defending position
- Ideal for solo practice or team settings
- Portable, lightweight, sets up and breaks down easily
- Adjustable telescoping pole (6.5' to 8') gives varying defensive options
- Base and ground stake included for stability

2004

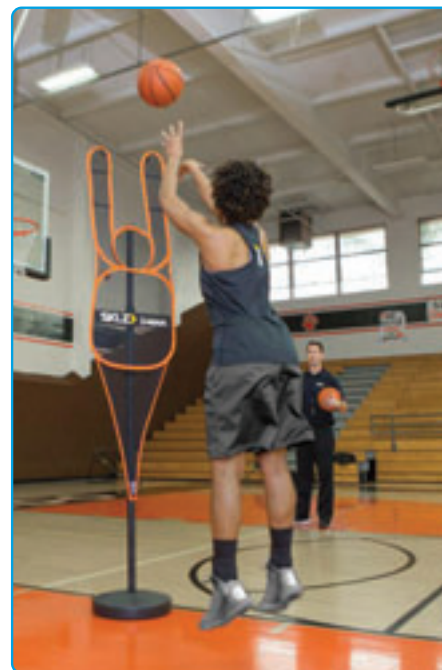

**MOLTEN BG4000
COMPOSITE LEATHER**

Introducing the brand new Molten BG4000 premium composite leather basketball. This FIBA approved 12 panel deep channel design is scuff resistant and laminated for your playing pleasure. Experience the latest generation of our best-selling competition ball. It features a new pebble design for excellent grip and a premium composite leather finish.

19135 Sizes: 5

19136 Sizes: 6

19137 Sizes: 7



**BADEN BASKETBALL
RUBBER ELITE**

For indoor or outdoor play.

BBR01 Sizes: 6

BBR02 Sizes: 7



**BADEN BASKETBALL
SKILLCOACH SHOOTER**

Built for kids that want to enhance their game. The Skillcoach Shooter's Ball teaches young kids proper hand placement when shooting.

BBS01 Sizes: 5



INFLATOR NEEDLES

4250	Thick	Each
4251	Thin	Each



SUPER COMPRESSOR INFLATION NEEDLES 3 PACK - THICK

- Wide threaded section
- Packet of 3
- Thin needle suitable for small valve inflatables

30033



SUPER COMPRESSOR INFLATION NEEDLES 12 PACK - THICK

- Wide threaded section
- Packet of 12
- Thin needle suitable for small valve inflatables

30034



HAND PUMP HEAVY DUTY

4242



BALL INFLATION NEEDLE 3 PACK - THIN

- Suitable to inflate Basketballs, Netballs, Soccer Balls, Volleyballs
- Suitable for small valve inflatables
- Blister pack of 3 needles

30035



BALL INFLATION NEEDLES 12 PACK - THIN

- Suitable to inflate Basketballs, Netballs, Soccer Balls, Volleyballs
- Suitable for small valve inflatables
- Blister pack of 12 needles

30036



COMPRESSOR HEAVY DUTY

4243	Compressor
4245	Replacement Compressor Hose



COMPRESSOR DELUXE

4244	Compressor
4245	Replacement Compressor Hose



HAND PUMP STANDARD

4249



BALL TOTE ON WHEELS

6567M Molten Ball Tote on Wheels
6567 Alliance Ball Tote on Wheels



STRING BAGS

2033 Large - Holds 14 Basketballs
2034 Medium - Holds 8 Basketballs
2035 Small



PATRICK DUAL ACTION PUMP

- Dual action: expels air on both push and pull actions
- Ball inflation valve and toning ball adaptors included

30037



SELECT DELUXE BAG WITH PVC BASE

6269S Small (Holds 4-5 Balls)
6269M Medium (Holds 10-12 Balls)
6269 Large (Holds 16-18 Balls)



PATRICK DELUXE BAG WITH PVC BASE

2032 Black
2032R Red
2032RB Royal Blue
2032NB Navy
2032FY Fluro Yellow
2032FO Fluro Orange
SPABBA12 Purple
SPABBA16 Green



DRIBBLING GOGGLES

2036

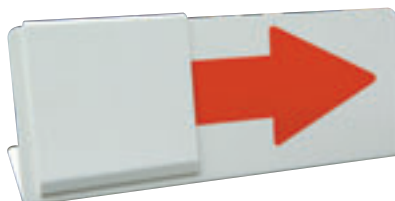

DELUXE POSSESSION ARROWS

2040



STANDARD POSSESSION ARROWS

SPA01

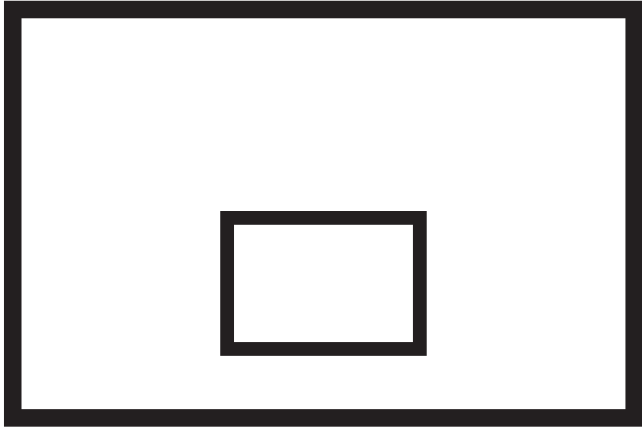

BASKETBALL BACKBOARDS

Made from Marine Grade Plywood to withstand the elements.

- 2063 A. Standard 1800 x 1200 x 18mm
- 2064 B. Standard 1200 x 900 x 17mm

PLEASE ALLOW 1-2 WEEKS FOR MANUFACTURING



REFEREE POLO SHIRT

- 1930S Sizes: Small
- 1930M Sizes: Medium
- 1930L Sizes: Large
- 1930XL Sizes: XL
- 1930XXL Sizes: XXL
- 1930XXXL Sizes: XXXL



POST PADDING CYLINDRICAL FOR BASKETBALL

- 2065 1800 x 160mm ID



BASKETBALL RING REMOVABLE

- 2041 With Plate
- 2042 Without Plate

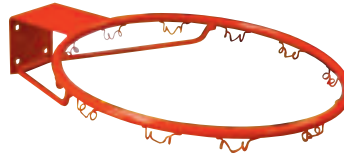

BASKETBALL RING DELUXE FIXED

- 2043 Deluxe Ring Fixed
- 2056 Acromat HD Ring



ACROMAT SNAP DOWN BASKETBALL RING

- 2055



CHAIN NET

- 2057



HD NYLON WHITE NET

- 2061



NYLON NET WHITE

- 2062



HD NYLON NET R/W/B

- 5932

Please visit www.slatertrellsports.com.au for up to date pricing.



**SPALDING
60" BEAST GLASS
BASKETBALL TOWER**

The 60" Beast® Portable Basketball System gives you the stability of an in-ground, but with a wheeled base that makes it easy to move. Featuring a 60" glass backboard giving you the true rebound you'd find on the professional court and a sturdy steel rim that can handle fierce dunks and drives. The Screw Jack lift system makes it easy to adjust the height of the rim to anywhere between 7.5 feet and the league-standard 10. Resting on a 208 litre base.

2072 Spalding 60" Beast Tower



**SPALDING
54" ULTIMATE HYBRID
GLASS BASKETBALL TOWER**

The home court is where legends begin with the portable 54" Ultimate Hybrid Glass Basketball System. Featuring a 54" glass backboard for unrivalled rebound performance with arena-style padding and a heavy-duty rim to withstand those vicious dunks. The Screw Jack lift system makes it easy to adjust the height of the system and the Ultimate Hybrid® base takes even less time to assemble than a traditional base.

BBT01 Spalding 54" Glass Tower

BBT01A Spalding 54" Platinum Acrylic Tower



**SPALDING
52" ACRYLIC
BASKETBALL TOWER**

- BOARD SIZE: 52 inch
- BOARD COMPOSITION: Steel Framed Acrylic
- LIFT TYPE: Exacta-Height™
- HEIGHT ADJUSTMENT: 7.5ft to 10.5ft
- RIM: Heavy Duty Pro-Slam™ breakaway
- BASE: 140 litres of water or 181 kgs of sand
- POLE: 3-piece, 3.5 inch round

BBT02 Spalding 52" Acrylic Tower



**SPALDING
50" ACRYLIC HERCULES
BASKETBALL TOWER**

- Acrylic backboard makes for quick rebounds
- Breakaway Pro-Slam rim for explosive slam dunks
- Exactaheight lift system lets you easily adjust the backboard height.
- 128 Litre Base.

2070 Spalding 50" Acrylic Tower



**SPALDING
48" ACRYLIC
BASKETBALL TOWER**

- BOARD SIZE: 48 inch
- BOARD COMPOSITION: Steel Framed Acrylic
- LIFT TYPE: Exacta-Height™
- HEIGHT ADJUSTMENT: 7.5ft to 10.5ft
- RIM: Heavy Duty Pro-Slam™ breakaway
- BASE: 140 litres of water or 181 kgs of sand
- POLE: 3-piece, 3.5 inch round

BBT03 Spalding 48" Acrylic Tower



**SPALDING
42" ENFORCER NO TOOLS
BASKETBALL TOWER**

Bring the court to your backyard with the portable 42" Enforcer Basketball System. Featuring a 42" polycarbonate backboard with improved rebound performance and easy height adjustability. This system stands on a 117 litre base which you can fill with sand or water.

BBT04 Spalding 42" No Tools Tower



**BASKETBALL BIB SET
NYLON SET OF 10**

Flow-through nylon basketball singlet style mesh bib. Set of 10, Numbered 4-13

2000JK	Junior Set (No. 4-13) Black
2000JE	Junior Set (No. 4-13) Emerald
2000JM	Junior Set (No. 4-13) Maroon
2000JR	Junior Set (No. 4-13) Red
2000JB	Junior Set (No. 4-13) Royal Blue
2000JY	Junior Set (No. 4-13) Yellow
2000SK	Senior Set (No. 4-13) Black
2000SE	Senior Set (No. 4-13) Emerald
2000SM	Senior Set (No. 4-13) Maroon
2000SR	Senior Set (No. 4-13) Red
2000SB	Senior Set (No. 4-13) Royal Blue
2000SY	Senior Set (No. 4-13) Yellow



PLAIN POLYESTER BIBS

2004W	White
2004K	Black
2004R	Red
2004RB	Royal
2004Y	Yellow
2004SKY	Sky Blue
2004M	Maroon
2004E	Emerald
2004P	Pink
2004BG	Bottle
2004PU	Purple
2004FO	Fluro Orange
2004FG	Fluro Green
2004NB	Navy Blue



**NETBALL BIB SET
POLYESTER SET OF 7**

2001JWK	Junior White/Black Ltrs
2001JKW	Junior Black/White Ltrs
2001JKP	Junior Black/Pink Ltrs
2001JRW	Junior Red/White Ltrs
2001JBW	Junior Royal/White Ltrs
2001JNW	Junior Navy/White Ltrs
2001JYB	Junior Yellow/Black Ltrs
2001JSB	Junior Sky/Black Ltrs
2001JBGW	Junior Bottle/White Ltrs
2001JMW	Junior Maroon/White Ltrs
2001JEB	Junior Emerald/Black Ltrs
2001JZW	Junior Purple/White Ltrs
2001JOB	Junior FL Orange/Black Ltrs
2001JGB	Junior FL Green/Black Ltrs
2001JPB	Junior FL Pink/Black Ltrs
2001SWK	Senior White/Black Ltrs
2001SKW	Senior Black/White Ltrs
2001SKP	Senior Black/Pink Ltrs
2001SRW	Senior Red/White Ltrs
2001SBW	Senior Royal/White Ltrs
2001SNW	Senior Navy/White Ltrs
2001SYB	Senior Yellow/Black Ltrs
2001SSB	Senior Sky/Black Ltrs
2001SBGW	Senior Bottle/White Ltrs
2001SMW	Senior Maroon/White Ltrs
2001SEB	Senior Emerald/Black Ltrs
2001SZW	Senior Purple/White Ltrs
2001SOB	Senior FL Orange/Black Ltrs
2001SGB	Senior FL Green/Black Ltrs
2001SPB	Senior FL Pink/Black Ltrs

OTHER NETBALL BIBS

2008	Special Make Up
2009	Printed Bib Single
2003	Plain Bib Single
2010	Special X-Large Set

**CUSTOM
NETBALL
BIB SETS**



**ALLIANCE REVERSIBLE
NETBALL BIBS**

- Pack of 7
- Regulation size
- Polyester material
- Ideal for clubs, schools or leisure
- Other side of bib is black

NBBSRJ0304	Red/Blue Junior
NBBSRJ0611	Yellow/Green Junior
NBBSRS0304	Red Blue Senior
NBBSRS0611	Yellow/Green Senior

**GILBERT REVERSIBLE
NETBALL BIBS**

- Pack of 7
- Regulation size
- Polyester material
- Ideal for clubs, schools or leisure
- Other side of bib is black



30045	Blue/Pink Junior
30044	Blue/Pink Senior
30039	Lime/Red Junior
30038	Lime/Red Senior

Please visit www.slatertrellsports.com.au for up to date pricing.



REVERSIBLE TRAINING SINGLETS

Breathable nylon mesh material. Can be worn with either colour outside to easily identify team members. Reinforced seams.

2011YRXS	Yellow/Red - XS
2011YRS	Yellow/Red - Small
2011YRM	Yellow/Red - Medium
2011YRL	Yellow/Red - Large
2011YRXL	Yellow/Red - XL
2011BPXS	Black/Pink - XS
2011BPS	Black/Pink - Small
2011BPM	Black/Pink - Medium
2011BPL	Black/Pink - Large
2011BPXL	Black/Pink - XL
2011RSXS	Royal/Sky - XS
2011RSS	Royal/Sky - Small
2011RSM	Royal/Sky - Medium
2011RSL	Royal/Sky - Large
2011RSXL	Royal/Sky - XL
2011OGXS	Orange/Green - XS
2011OGS	Orange/Green - Small
2011OGM	Orange/Green - Medium
2011OGL	Orange/Green - Large
2011OGL	Orange/Green - XL



PATRICK NUMBERED SINGLETS

Flow-through nylon basketball singlet style mesh bib. Set of 10 or 15.

2012YS	Yellow Set of 10 - No.1-10 Small
2012OS	Orange Set of 10 - No.1-10 Small
2012BS	Blue Set of 10 - No.1-10 Small
2012GS	Green Set of 10 - No.1-10 Small
2012YM	Yellow Set of 10 - No.1-10 Medium
2012OM	Orange Set of 10 - No.1-10 Medium
2012BM	Blue Set of 10 - No.1-10 Medium
2012GM	Green Set of 10 - No.1-10 Medium
2012YL	Yellow Set of 10 - No.1-10 Large
2012OL	Orange Set of 10 - No.1-10 Large
2012BL	Blue Set of 10 - No.1-10 Large
2012GL	Green Set of 10 - No.1-10 Large
2013YS	Yellow Set of 5 - No.11-15 Small
2013OS	Orange Set of 5 - No.11-15 Small
2013BS	Blue Set of 5 - No.11-15 Small
2013GS	Green Set of 5 - No.11-15 Small
2013YM	Yellow Set of 5 - No.11-15 Medium
2013OM	Orange Set of 5 - No.11-15 Medium
2013BM	Blue Set of 5 - No.11-15 Medium
2013GM	Green Set of 5 - No.11-15 Medium
2013YL	Yellow Set of 5 - No.11-15 Large
2013OL	Orange Set of 5 - No.11-15 Large
2013BL	Blue Set of 5 - No.11-15 Large
2013GL	Green Set of 5 - No.11-15 Large
2014YS	Yellow Set of 5 - No.16-20 Small
2014OS	Orange Set of 5 - No.16-20 Small
2014BS	Blue Set of 5 - No.16-20 Small
2014GS	Green Set of 5 - No.16-20 Small
2014YM	Yellow Set of 5 - No.16-20 Medium
2014OM	Orange Set of 5 - No.16-20 Medium
2014BM	Blue Set of 5 - No.16-20 Medium
2014GM	Green Set of 5 - No.16-20 Medium
2014YL	Yellow Set of 5 - No.16-20 Large
2014OL	Orange Set of 5 - No.16-20 Large
2014BL	Blue Set of 5 - No.16-20 Large
2014GL	Green Set of 5 - No.16-20 Large
2015YS	Yellow Set of 5 - No. 21-25 Small
2015OS	Orange Set of 5 - No.21-25 Small
2015BS	Blue Set of 5 - No.21-25 Small
2015GS	Green Set of 5 - No.21-25 Small
2015YM	Yellow Set of 5 - No. 21-25 Medium
2015OM	Orange Set of 5 - No.21-25 Medium
2015BM	Blue Set of 5 - No.21-25 Medium
2015GM	Green Set of 5 - No.21-25 Medium
2015YL	Yellow Set of 5 - No. 21-25 Large
2015OL	Orange Set of 5 - No.21-25 Large
2015BL	Blue Set of 5 - No.21-25 Large
2015GL	Green Set of 5 - No.21-25 Large



TRAINING SINGLET SG PRO

Airflow mesh material for superior cool comfort. Reinforced seams for durability.

2004XSY	XS Yellow
2004XSB	XS Royal Blue
2004XSR	XS Red
2004XSW	XS White
2004XSBG	XS Bright Green
2004XSBO	XS Bright Orange
2004XSK	XS Black
2004XSP	XS Pink
2004SY	Small Yellow
2004SB	Small Royal Blue
2004SR	Small Red
2004SW	Small White
2004SBG	Small Bright Green
2004SBO	Small Bright Orange
2004SK	Small Black
2004SP	Small Pink
2004MY	Medium Yellow
2004MB	Medium Royal Blue
2004MR	Medium Red
2004MW	Medium White
2004MBG	Medium Bright Green
2004MBO	Medium Bright Orange
2004MK	Medium Black
2004MP	Medium Pink
2004LY	Large Yellow
2004LB	Large Royal Blue
2004LR	Large Red
2004LW	Large White
2004LBG	Large Bright Green
2004LBO	Large Bright Orange
2004LK	Large Black
2004LP	Large Pink
2004XLY	XL Yellow
2004XLB	XL Royal Blue
2004XLR	XL Red
2004XLW	XL White
2004XLBG	XL Bright Green
2004XLBO	XL Bright Orange
2004XLK	XL Black
2004XLP	XL Pink
SPTBB/B/XXL	XXL Blue
SPTBB/Y/XXL	XXL Yellow
SPTBB/K/XXL	XXL Orange
SPTBB/G/XXL	XXL Green



CHESS

2100 Chess



PLAYING CARDS

2106 Playing Cards



PICTIONARY

2103 Pictionary



CHECKERS

2105 Checkers



FLICKERZ DISCS 3 PACK

22017 3 Pack



FLICKERZ DISC

22018 1 Pack

GAME BOOKS

- 2160 Fun & Games
- 2161 Best New Games
- 2162 Parachute Games
- 2163 101 Warm Up + Cool Down Games
- 2164 Team Building Thru Phys Challenges
- 2165 Station Games
- 2166 Senior Physical Education
- 2167 Fitness Fun
- 2168 Pedometer Power
- 2169 Teaching Children Dance
- 2170 Social Dance Steps to Success
- 2171 Gymnastics Fun and Games
- 2172 Speed Agility and Quickness Training
- 2173 DVD available for all sport and PE



FLICKERZ

Flickable Flying Discs. Target Net. Unlimited Flicking Fun Indoors & Outdoors. Flies over 70 Feet! Includes: 6 Flickerz Discs, Flickerz Target Net, Score Pad & Pencil.

22016 Flickerz



Baseball/Softball Board (Front) Baseball/Softball Board (Back)

BASEBALL / SOFTBALL BOARD

- Magnetic whiteboard front and back
- 25 magnetic name tags
- Write on and wipe off
- Marker pen and pen clip
- Carry handle
- Lightweight and sturdy construction

2220 Size: 36cm x 46cm



Basketball Board (Front) Basketball Board (Back)

BASKETBALL BOARD

- Magnetic whiteboard front and back
- 25 magnetic name tags
- Write on and wipe off
- Marker pen and pen clip
- Carry handle
- Lightweight and sturdy construction

2204 Size: 30cm x 40cm

100066 Size: 36cm x 46cm



Blank Pro Board (Front) Blank Pro Board (Back)

BLANK PRO BOARD

- Magnetic whiteboard front and back
- 25 magnetic name tags
- Write on and wipe off
- Marker pen and pen clip
- Carry handle
- Lightweight and sturdy construction

2217 Size: 36cm x 46cm

100067 Size: 52cm x 60cm



Cricket Pro Board (Front) Cricket Pro Board (Back)

CRICKET PRO BOARD

- Magnetic whiteboard front and back
- 50 magnetic name tags for 4 teams
- Write on and wipe off
- Marker pen and pen clip
- Carry handle
- Lightweight and sturdy construction

100068 Size: 36cm x 46cm



Hockey Board (Front) Hockey Board (Back)

HOCKEY BOARD

- Magnetic whiteboard front and back
- 25 magnetic name tags
- Write on and wipe off
- Marker pen and pen clip
- Carry handle
- Lightweight and sturdy construction

2206 Size: 30cm x 40cm



Netball Board (Front) Netball Board (Back)

NETBALL BOARD

- Magnetic whiteboard front and back
- 25 magnetic name tags
- Write on and wipe off
- Marker pen and pen clip
- Carry handle
- Lightweight and sturdy construction

SIZE: 30cm x 40cm

2218 Size: 30cm x 40cm



Rugby League Pro Board (Front) Rugby League Pro Board (Back)

RUGBY LEAGUE PRO BOARD

- Magnetic whiteboard front and back
- 25 magnetic name tags
- Write on and wipe off
- Marker pen and pen clip
- Carry handle
- Lightweight and sturdy construction

2222 Size: 36cm x 46cm



Rugby Union Pro Board (Front) Rugby Union Pro Board (Back)

RUGBY UNION PRO BOARD

- Magnetic whiteboard front and back
- 25 magnetic name tags
- Write on and wipe off
- Marker pen and pen clip
- Carry handle
- Lightweight and sturdy construction

2223 Size: 36cm x 46cm



Soccer Pro Board (Front) Soccer Pro Board (Back)

SOCCER STANDARD BOARD

- Magnetic whiteboard front and back
- 25 magnetic name tags
- Write on and wipe off
- Carry handle
- Lightweight and sturdy construction

2219 Size: 30cm x 40cm

100069 Size: 36cm x 46cm



Soccer Pro Board (Front) Soccer Pro Board (Back)

Soccer Pro Board

- Magnetic whiteboard front and back
- 25 magnetic name tags
- Write on and wipe off
- Marker pen and pen clip
- Carry handle
- Lightweight and sturdy construction
- Includes Digital Sports Timer

2208 Size: 36cm x 46cm



Touch Football Board (Front) Touch Football Board (Back)

Touch Football Board

- Magnetic whiteboard front and back
- 25 magnetic name tags
- Write on and wipe off
- Marker pen and pen clip
- Carry handle
- Lightweight and sturdy construction

2215 Size: 36cm x 46cm



Water Polo Pro Board (Front) Water Polo Pro Board (Back)

Water Polo Pro Board

- Magnetic whiteboard front and back
- 25 magnetic name tags
- Write on and wipe off
- Marker pen and pen clip
- Carry handle
- Lightweight and sturdy construction

2216 Size: 36cm x 46cm



Volleyball Board (Front) Volleyball Board (Back)

Volleyball Board

- Magnetic whiteboard front & back
- Court on front
- Blank back
- 25 magnetic name tags (50mm x 12mm)
- Write on and wipe off
- Marker pen and pen clip
- Carry handle
- Lightweight & sturdy construction
- Size: 30cm x 40cm

30061 Size: 30cm x 40cm



AFL Standard Board (Front) AFL Standard Board (Back)

AFL Standard Board

- Magnetic whiteboard front and back
- 25 magnetic name tags
- Write on and wipe off
- Carry handle
- Lightweight and sturdy construction

2200 Size: 30cm x 40cm

100070 Size: 36cm x 46cm

100071 Size: 60cm x 90cm



AFL Pro Board (Front) AFL Pro Board (Back)

AFL Pro Board

- Magnetic whiteboard front and back
- 35 magnetic name tags
- Write on and wipe off
- Marker pen and pen clip
- Carry handle
- Lightweight and sturdy construction
- Includes Digital Sports Timer

2201 Size: 36cm x 46cm



AFL Super Deluxe Board (Front)

AFL Super Deluxe Board

- Magnetic whiteboard front and back
- 40 magnetic name tags
- Write on and wipe off
- 2 marker pens and pen clips
- Carry handle
- Ideal for senior level coaching
- Back – plain magnetic whiteboard
- Includes Digital Sports Timer

2202 Size: 60cm x 52cm



AFL Game Day Board (Front)

AFL Game Day Board

- Magnetic whiteboard front only
- 35 jumbo magnetic name tags
- Write on and wipe off
- 2 marker pens and pen clips
- Clip on pen tray
- For meeting and change rooms
- Wall mountable aluminium frame

AGDB Size: 140cm x 120cm



AFL KPI Board (Front)

AFL KPI Board

- Magnetic whiteboard front and back
- 10 magnetic tags
- Write on and wipe off
- 2 marker pens and pen clips
- Carry handle
- Measure on field performance
- Measure KPI's with 4 quarter view plus game total
- Back – plain magnetic whiteboard

KPI01 Size: 60cm x 45cm



AFL Folder

DELUXE AFL COACHING FOLDER

- Clip holder for note pad
- Magnetic whiteboard
- 25 magnetic name tags
- Marker pen
- Water resistant

2203 Size: 35cm x 46cm (Open)



Baseball/Softball Folder

DELUXE BASEBALL / SOFTBALL COACHING FOLDER

- Clip holder for note pad
- Magnetic whiteboard
- 25 magnetic name tags
- Marker pen
- Water resistant

2213 Size: 35cm x 46cm (Open)



Basketball Folder

DELUXE BASKETBALL COACHING FOLDER

- Clip holder for note pad
- Magnetic whiteboard
- 25 magnetic name tags
- Marker pen
- Water resistant

2205 Size: 35cm x 46cm (Open)



Hockey Folder

DELUXE HOCKEY COACHING FOLDER

- Clip holder for note pad
- Magnetic whiteboard
- 25 magnetic name tags
- Marker pen
- Water resistant

2207 35cm x 46cm (Open)



Rugby League Folder

DELUXE RUGBY LEAGUE COACHING FOLDER

- Clip holder for note pad
- Magnetic whiteboard
- 25 magnetic name tags
- Marker pen
- Water resistant

2211 35cm x 46cm (Open)



Rugby Union Folder

DELUXE RUGBY UNION COACHING FOLDER

- Clip holder for note pad
- Magnetic whiteboard
- 25 magnetic name tags
- Marker pen
- Water resistant

2212 35cm x 46cm (Open)



Soccer Folder

DELUXE SOCCER COACHING FOLDER

- Clip holder for note pad
- Magnetic whiteboard
- 25 magnetic name tags
- Marker pen
- Water resistant

2209 35cm x 46cm (Open)



Netball Folder

DELUXE NETBALL COACHING FOLDER

- Clip holder for note pad
- Magnetic whiteboard
- 25 magnetic name tags
- Marker pen
- Water resistant

2210 35cm x 46cm (Open)



Blank Folder

DELUXE BLANK COACHING FOLDER

- Clip holder for note pad
- Magnetic whiteboard
- 25 magnetic name tags
- Marker pen
- Water resistant

100072 35cm x 46cm (Open)



DIGITAL SPORTS TIMER

- Ideal for timekeeping
- Free standing
- Magnetic
- Used for player changes
- Timing of ¼ and ½
- Long battery life

SDT01



U-SHAPED MAGNETS

U001	Size: 60mm x 15mm (Pack 25)
U002	Size: 75mm x 25mm (Pack 25)
U003	Size: 100mm x 25mm (Pack 25)
U004	Size: 150mm x 25mm (Pack 25)



MAGNETIC STRIPS

2240	White: 50mm x 12mm (Pack 25)
2241	White: 60mm x 15mm (Pack 25)
2242	White: 75mm x 20mm (Pack 25)
2243	White: 100mm x 25mm (Pack 25)
2244	White: 125mm x 30mm (Pack 25)
2240Y	Yellow: 50mm x 12mm (Pack 25)
2241Y	Yellow: 60mm x 15mm (Pack 25)
2242Y	Yellow: 75mm x 20mm (Pack 25)
2243Y	Yellow: 100mm x 25mm (Pack 25)
2240O	Orange: 50mm x 12mm (Pack 25)
2241O	Orange: 60mm x 15mm (Pack 25)
2242O	Orange: 75mm x 20mm (Pack 25)
2243O	Orange: 100mm x 25mm (Pack 25)



ROUND MAGNETS

2245R	Red: Round 20mm (Pack 25)
2245Y	Yellow: Round 20mm (Pack 25)
2245B	Blue: Round 20mm (Pack 25)
2245W	White: Round 20mm (Pack 25)



ROUND RAISED MAGNETS

30051	Black: Round 20mm (Pack 25)
30052	Black: Round 20mm (Pack 50)
30053	Blue: Round 20mm (Pack 25)
30054	Blue: Round 20mm (Pack 50)
30055	Red: Round 20mm (Pack 25)
30056	Red: Round 20mm (Pack 50)
30057	Yellow: Round 20mm (Pack 25)
30058	Yellow: Round 20mm (Pack 50)
30059	Mixed Pack: Round 20mm (Pack 25)
30060	Mixed Pack: Round 20mm (Pack 50)



COACHES KIT

- Includes: satchel, deluxe folder, 25 magnetic name tags, marker pen, notepad, biro, whistle and lanyard
- Available in AFL, Baseball/Softball, Basketball, Hockey, Netball, Rugby League, Rugby Union, Soccer and Blank

ACK01



COACHING BOARD CARRY BAG

- Ideal for medium size coaching boards
- Zip compartment for name tags, pens, keys and coaching materials

SBCB01	Medium: 53cm x 41cm
SBCB02	Large: 64cm x 60cm



SATCHEL

- Ideal for Folders and Budget Boards
- Lightweight design

SAT01	Size: 34cm x 44cm
-------	-------------------



ADVANCED SPORTS NUTRITION

2123

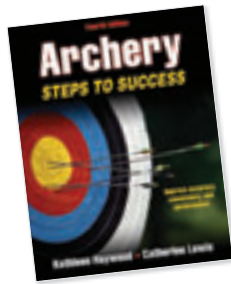

ARCHERY STEPS TO SUCCESS

2108



BADMINTON STEPS TO SUCCESS

2109

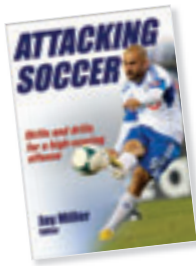

ATTACKING SOCCER

2109AS



BASKETBALL SKILLS & DRILLS

2110

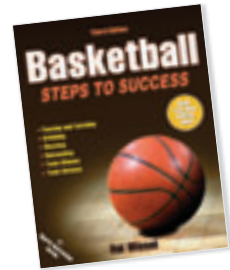

BASKETBALL STEPS TO SUCCESS

2111



AUSTRALIAN FOOTBALL STEPS TO SUCCESS

2109AFSTS



COACHING EXCELLENCE

2109CE

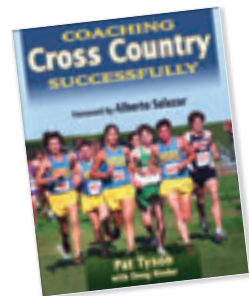

COACHING CROSS COUNTRY

2109CCC



COACHING TRACK & FIELD

2133



COMPLETE CONDITIONING FOR GOLF

2109CCFG



CUTTING EDGE CRICKET

2109CEC

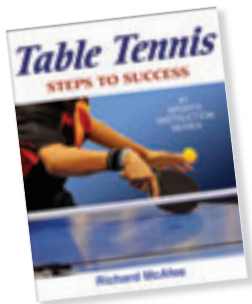

**TABLE TENNIS
STEPS TO
SUCCESS**

2109TSTS

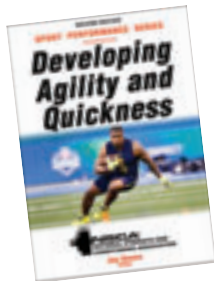

**DEVELOPING
AGILITY
& QUICKNESS**

2109DAQ



**WEIGHT TRAINING
STEPS TO SUCCESS**

2109WTSTS

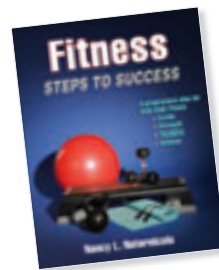

**FITNESS
STEPS TO
SUCCESS**

2109FITSTS



**SWIMMING
DRILL BOOK**

SDB01



**STRENGTH AND
CONDITIONING FOR
YOUNG
ATHLETES**

SCA01



**CHICKEN NOODLE
GAMES**

CNG01



**VOLLEYBALL STEPS
TO
SUCCESS**

CNG01

OTHER SPORT BOOKS

2109CBS	Coaching Basketball Successfully
2109CGS	Coaching Girls Soccer
2109MIT	Maximum Interval Training
2109FR	Fitness Running
2109HMT	Half Marathon Training
2109HRT	Heart Rate Training
2109HPP	High-Powered Plyometrics
2109KT	Kettlebell Training
2109TH	Tennis Handbook

2126	Soccer Steps to Success
2109SIG	Sports Injuries Guidebook
2109SOTS	Softball Steps to Success
2131	Swimming Steps to Success
2132	Tennis Skills & Drills
2109VCB	The Volleyball Coaching Bible
2109TFS	Training for Speed, Agility & Quickness
2109VSD	Volleyball Skills & Drills

CAN'T FIND IT?
***Tell us what book you need
 and we will find it.***



SUPER SOFTBALL

2350J Kookaburra Jnr
2350S Kookaburra Snr

Flat Seam. Soft Feel.



SUPA SOFT

2351J Kookaburra Jnr
2351S Kookaburra Snr

High Seam. Softer Starter Feel.



SOFTABALL

2352J Kookaburra Jnr
2352S Kookaburra Snr

High Seam. Firm Starter Feel.



PLYABALL

2353 Platypus Plyaball



PRACTICE RED

2301J Kookaburra 142g
2301S Kookaburra 156g



PRACTICE WHITE

2302J Kookaburra 142g
2302S Kookaburra 156g



RED KING

2303J Kooka 2pc 142g
2303S Kooka 2pc 156g
2303B Red King Bi-Colour



SPECIAL TEST RED

2304J Kooka 2pc 142g
2304S Kooka 2pc 156g



SPECIAL TEST WHITE

2305J Kooka 2pc 142g
2305S Kooka 2pc 156g



TUF PITCH

2306S Kooka 2pc 156g



METEOR

2373 Red 4pc 156g
2373W White 4pc 156g



SENATOR

2307 Kooka 4pc 156g



REGULATION REJECT

2308 Red 4pc 156g
2308W White 4pc 156g



CLUB MATCH

2309 Red 4pc 156g
2309W White 4pc 156g



REGULATION

2310 Red 4pc 156g
2310W White 4pc 156g
2310O Orange 4pc 156g
2310P Pink 4pc 156g



CROWN RED

2311J Kookaburra 142g
2311S Kookaburra 156g



BOWLING MACHINE BALL

2370 Jugs Yellow Dimple



JUGS BOWLING MACHINE

THE NUMBER 1 CRICKET BOWLING MACHINE IN THE WORLD.

Simulates all deliveries:

- Out-swing, in-swing.
- Fast rising deliveries
- Slow spin etc

Quick and easy adjustments:

- Speed as well as line and length

Suitable for all age groups:

- Juniors to Test players
- Speed 32-167 kph (20-104mph)

Portable and easy to move and set up:

- Convenient 240 Volt/Extension Lead or Generator.
- Can fit into the boot of your car.

New improved safe feeding chute:

- Guides the ball to contact tyres in the correct position, thus ensuring accurate deliveries.

Robust construction:

- Guaranteed to outlast any other bowling machine (have been operating successfully in Australia for 25 years).

\$4100.00 2371



Various Brands Available.

ENGLISH WILLOW CRICKET BATS

2411	A. English Willow Grade 1
2410	B. English Willow Grade 2
2405	C. English Willow Small Mens
2403	C. English Willow Classic
2406	D. English Willow Harrow
2407	D. English Willow Size 6
2408	D. English Willow Size 5
2409	D. English Willow Size 4

FILM & KNOCK-IN

2506	Film & Knock-In
------	-----------------



Various Brands Available.

KASHMIR WILLOW CRICKET BATS

2500	A. Kashmir Willow Senior
2501	B. Kashmir Willow Harrow
2505	C. Kashmir Willow 4
2504	C. Kashmir Willow 5
2503	C. Kashmir Willow 6

Please visit www.slatertrellsports.com.au for up to date pricing.



EXCLUSIVE KNOCKING-IN MACHINE

Exclusive to Slater-Gartrell Sports in Western Australia is our automated knocking in machine. This machine replicates the knocking in process in a matter of minutes and strikes the bat face approximately 1600 times. Some final hand knocking in is recommended.

All new cricket bats require knocking in before use, knocking in is the process of hardening and conditioning of the bats surface.

Knocking in will protect the face of the bat from cracking and increase the bats life span. Knocking in also improves the "middle" of the bat so that it is larger and better thus improving how far the ball will travel once struck by the bat.

Linseed oil is used to moisten the surface of the bat and enables the fibres to become supple and knit together, forming an elastic surface. This is more likely to stretch on impact rather than crack.

Slater-Gartrell Sports recommends the use of the knocking in machine on all new bats and a final hand knock in using a hardwood mallet concentrating on the edges of the bat to round them off so the ball cannot damage them too much. The edges should be struck at 45 degrees to the face, gradually work on the edges until the whole surface is smooth and has a rounded appearance. The back of the bat should never be touched with mallet or ball. The hardwood mallet knocking in process should take between 10 to 15 sessions of about 10 minutes each. Once completed the bat is ready for play. Start by hitting old balls in the nets and check the face for very deep seam marks to the point of almost cracking the face, if this occurs further knocking in is required. Seam marks will always occur on the face of the bat but they should not be too deep.



BATTING PADS

2600ML	A. Mens - Left Handed Batsman
2600MR	A. Mens - Right Handed Batsman
2600YL	A. Youth - Left Handed Batsman
2600YR	A. Youth - Right Handed Batsman
2600BL	A. Boys - Left Handed Batsman
2600BR	A. Boys - Right Handed Batsman
2601ML	B. Mens - Left Handed Batsman
2601MR	B. Mens - Right Handed Batsman
2601YL	B. Youth - Left Handed Batsman
2601YR	B. Youth - Right Handed Batsman
2601BL	B. Boys - Left Handed Batsman
2601BR	B. Boys - Right Handed Batsman

All makes and sizes available on website.



WICKET KEEPING PADS

2700M	A. Wicket Keeping Pads Mens
2700Y	A. Wicket Keeping Pads Youth
2701M	B. Wicket Keeping Pads Mens
2701Y	B. Wicket Keeping Pads Youth

All makes and sizes available on website.





BATTING GLOVES

2750MLH	A. Pro Mens - LH Batsman
2750YLH	A. Pro Youth - LH Batsman
2750BLH	A. Pro Boys - LH Batsman
2750MRH	A. Pro Mens - RH Batsman
2750YRH	A. Pro Youth - RH Batsman
2750BRH	A. Pro Boys - RH Batsman
2751MLH	B. Standard Mens - LH Batsman
2751YLH	B. Standard Youth - LH Batsman
2751BLH	B. Standard Boys - LH Batsman
2751MRH	B. Standard Mens - RH Batsman
2751YRH	B. Standard Youth - RH Batsman
2751BRH	B. Standard Boys - RH Batsman
2752MLH	C. Pride - Mens - LH Batsman
2752YLH	C. Pride - Youth - LH Batsman
2752BLH	C. Pride - Boys - LH Batsman
2752MRH	C. Pride - Mens - RH Batsman
2752YRH	C. Pride - Youth - RH Batsman
2752BRH	C. Pride - Boys - RH Batsman
All makes and sizes available on website.	



WICKET KEEPING GLOVES

2710M	A. Mens
2710Y	A. Youth
2710B	A. Boys
2711M	B. Mens
2711Y	B. Youth
2711B	B. Boys
2712M	C. Mens
2712Y	C. Youth
2712B	C. Boys
All makes and sizes available on website.	



CUSTOM HELMET WITH LOGO

2790M	Mens
2790Y	Youth
2790B	Boys



CLUB HELMETS

2791M	Mens
2791Y	Youth
2791B	Boys



MASURI HELMETS

VS001	VS Elite Senior
VS002	VS Elite Junior
LS001	Legacy Senior
LJ002	Legacy Junior



ELITE DUFFLE WHEEL BAG

30062	Elite Duffle Bag
-------	------------------



DELUXE WHEEL BAG

2770	Deluxe Wheelie Bag
------	--------------------



CLUB WHEEL BAG

2771	Club Wheel Bag
------	----------------



NYLON GEAR BAG

2772	Gear Bag
------	----------

CRICKET SYNTHETIC TURF

CRICKET TURF

Supply & laying SG premium
12mm turf for 35 Years.
Contact: John Gartrell (08) 9274 5788

SG Shield 12mm turf manufactured exclusively for Slater Gartrell Sports to our specifications. A long lasting cricket specific turf that has great longevity. Some wickets have lasted over 12 years.

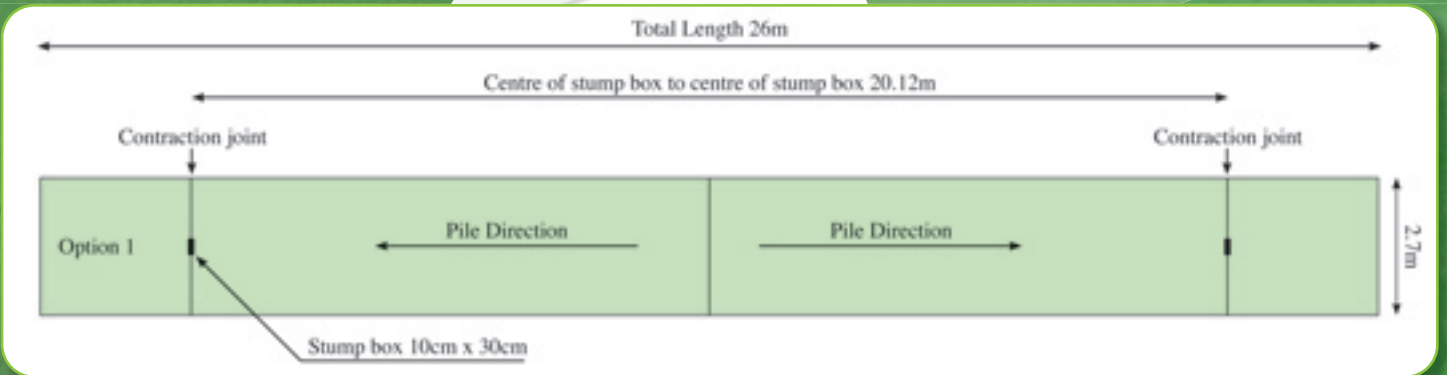



KEEPING & BATTING INNERS

2801	Batting Inners - Mens
2802	Batting Inners - Youth
2803	Wicket Keeping Inners - Mens
2804	Wicket Keeping Inners - Youth

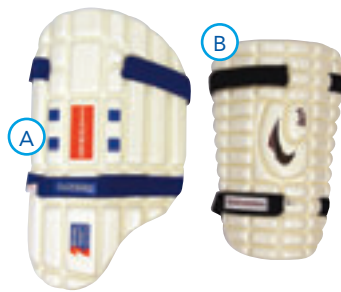

THIGH GUARDS

2810	A. Thigh Guards - Mens
2811	A. Thigh Guards - Youth
2812	A. Thigh Guards - Boys
2813	B. Thigh Guards - Mens
2814	B. Thigh Guards - Youth
2815	B. Thigh Guards - Boys



CRICKET PROTECTORS

2820	Mens
2821	Youth
2822	Boys

FOREARM GUARDS

2825	Mens
2826	Youth
2827	Boys



STUMPS PREMIUM 2 ENDS

2850	A. Kookaburra Test
2851	Gray Nicolls Shield



STUMPS PLAIN 2 ENDS

2852	Stumps Plain
------	--------------



STUMPS

2853	A. Metal Stumps 2 Ends
2854SS	B. Single Spring Stump
FS-2	C. Fusion Stump



BAILS STANDARD 2 ENDS

2855	
------	--



BOWLING MARKERS

2856	Single Marker
------	---------------



PORTABLE FLIP OVER SCOREBOARD

2833	
------	--

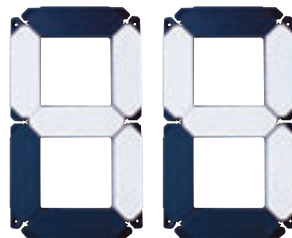

DIGITAL SCORE NUMBERS

2834	29cm (H) x 16cm (W)	Each
------	---------------------	------

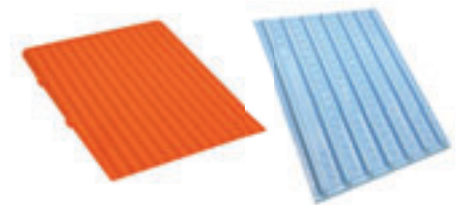

KATCHIT

2835	Orange Katchit
2835AO	Blue Katch Add On



BAT OIL LINSEED OIL

2829



FIBREGLASS TAPE ROLL

2830



BAT FILM PROTECTION

2831 Length of Bat Film



SCOREBOOK SACHEL

2836



UMPIRE COUNTERS

2838



CSW CRICKET SCOREBOOK

2837



CATCHERS CRICKET BAT

2861



BAT GRIPS & BAT CONE

- 2859 Bat Grip - Diamond Jnr Each
- 2858 Bat Grip - Diamond Snr Each
- 2857 Bat Cone - Grip Applicator



CRAZY CATCH

- WC002 Wild Child 2.0
- PRO20 Professional



BOWLER OFF STUMP TARGET

2839



SIDEARM PRO

The Pro is where the Sidearm™ really gets interesting. It requires a slightly stronger throwing arm to use than the club, but once mastered can produce deliveries that can test and challenge the very best of batters.

SIDEARM CLUB

Sidearm™ Club is designed to allow colt, novice and village cricketers the best practice available. It's very easy to use, and can be mastered by most cricketers within 5 or 10 minutes. A great way for parents whose throwing and bowling days may be behind them to give little johnny or johnetta top quality practice whenever they need it..

- 123SP Sidearm Pro
- 123SC Sidearm Club



INDOOR CRICKET

- 2900 A. Gray Nicolls Indoor Cricket Bat
- 2901 B. Batting Gloves - Leather Palm
- 2902 C. Wicket Keeping Gloves - Indoor
- 2903 D. Spring Stump (Per End)
- 2904 E. Gray Nicolls Wooden Spring Stump (Per End)
- 2905 F. Indoor Ball Leather Super Soft Green and Red Stitching
- 2906 G. Indoor Ball Leather Low Impact Red Stitching



OZ / MILO / KANGA CRICKET

- 2920 A. Harrow Bat
- 2921 B. Size 5 Bat
- 2922 C. Size 3 Bat
- 2923 D. Modified Junior Ball
- 2924 E. Full Size Senior Ball
- 2925 F. Batting Tee Large
- 2926 G. Batting Tee Small
- 2927 H. Stumps One End
- 2928 I. Base Only
- 2929 J. Stumps Single
- 2930 K. Field Marker
- 2931 L. SG Gear Bag 90cm (Length)
- 2932 M. Size 3 set Kindy/Primary School
- 2933 Size 5 set Middle School
- 2934 Harrow set Middle School



Bat Sizes differ for each set - Size 3, Size 5 and Harrow



KANGA CRICKET

2942 Complete Cricket Kit (Large)

CRICKET EQUIPMENT
 REPAIRS & MAINTENANCE TEL: 08 9274 5788



alliance

**MAKING FUN
A REALITY**



BALANCE BEAM SET - 8 SHAPE

Experience the thrill of balance and unleash your child's inner acrobat with the incredible 8-Shape Balance Beam. Designed to enhance body awareness, coordination, and balance, this dynamic piece of equipment promises endless fun and skill development for youngsters.

Specifications:

Contains 27 coloured (Red, Blue, Green, Yellow) pieces
 Straight Pieces: 8 total - 2 of each colour
 Curved Pieces: 18 total - 5 x Yellow & Green, 4 x Blue & Red
 Four-way Joiner: 1 total - Yellow
 Perfect for balance practice

Size:

Piece: 28cm long x 16.5cm high
 Walking surface: 5cm wide
 Base: 15cm wide

GABB8



WALKING BEAM SET OF 12 - STRAIGHT

Experience the thrill of balance and unleash your child's inner acrobat with the incredible Straight Walking Beam. Designed to enhance body awareness, coordination, and balance, this dynamic piece of equipment promises endless fun and skill development for youngsters.

Specifications:

Contains 12 pieces - 3 x each colour (Red, Blue, Green, Yellow)
 Perfect for balance practice

Size:

Piece: 28cm long x 16.5cm high
 Walking surface: 5cm wide
 Base: 15cm wide
 Total beam length: 3.36m

GABS

WALKING BEAM SET OF 12 - CURVED

This Curved Balance Beam is a fun piece of balance equipment for improving movement awareness, coordination and balance in youngsters.

Specifications:

Contains 12 pieces
 Can be set up as a complete circle or S shape

Size:

Piece: 28cm long x 16.5cm high
 Total beam length: 3.36m
 Walking surface: 5cm wide
 Base: 15cm wide

GABC





BEAR BEAN BAG

Length: 12cm

33178



CROCODILE BEAN BAG

Length: 17cm

33188



ELEPHANT BEAN BAG

Length: 13cm

33177



FROG BEAN BAG

Length: 11cm

33191



GORILLA BEAN BAG

Length: 13cm

33193



PENGUIN BEAN BAG

Length: 11cm

33181



PIG BEAN BAG

Length: 12cm

33179



PLATYPUS BEAN BAG

Length: 19cm

33189



TURTLE BEAN BAG

Length: 14cm

33190



WHALE BEAN BAG

Length: 14cm

33180



ANIMAL BEAN BAG KIT 31 ANIMALS

Create your own bean bag zoo with this fun and colourful kit. Includes drum carry bag for transport and storage.

Kit Includes:

- 3 Whales
- 3 Penguins
- 3 Gorillas
- 3 Frogs
- 3 Turtles
- 3 Crocodiles
- 3 Platypus
- 3 Pigs
- 3 Bears
- 3 Elephants
- 1 HART Drum Carry Bag

33196



BEETLE BEAN BAG SET

Fun set of soft and colourful ladybird bean bags for heaps of throwing and catching fun with some numeracy thrown in! Numbered One to Twenty with the numerals and count dots on one side with the written number on the other side. Includes mesh carry bag.

33176 Each bean bag is 5cm high and 9cm diameter.



NUMBER BEAN BAG SET

Colourful soft feel vinyl with overlock stitching for added durability. Wipes clean. Improve numeracy skills. Each set of ten bean bags is numbered 1-10. Size: 12cm x 12cm.

33172 Set of 10



ALPHABET BEAN BAG SET

Colourful soft feel vinyl with overlock stitching for added durability. Wipes clean. Added educational value with upper & lower case letters. Each set includes 26 bean bag marked A-Z. Size: 12cm x 12cm.

33170 Set of 26



COLOUR BEAN BAG SET

Colourful soft feel vinyl with overlock stitching for added durability. Wipes clean. Each set includes 6 different coloured bean bags. Size: 12cm x 12cm.

33173 Set of 6



SHAPE BEAN BAG SET

Colourful soft feel vinyl with overlock stitching for added durability. Wipes clean. Great tools for shape and colour identification. Each set of twelve includes - 3 Circles, 3 Triangles, 3 Rectangles & 3 Squares.

33171 Set of 12



FLAT BEAN BAG SET

Colourful soft feel vinyl with overlock stitching for added durability. Wipes clean. Soft leather feel. Each set includes one blue, green, yellow and red bag. Size: 15cm x 10cm.

33174 Set of 4



BEAN BAG BALL

Colourful soft feel vinyl with overlock stitching for added durability. Wipes clean. Soft leather feel. These balls are lightweight and easy to throw and catch. Suitable for small and large hands. Size: 8cm diameter

33187



CUBE BEAN BAG SET 7CM

Perfect for throwing and catching games. Colourful soft feel vinyl with overlock stitching. Bean bags are filled with plastic pellets which are phthalate compliant. Set includes one Blue, Green, Red and Yellow. Size: 7cm

33198 7cm Set



CUBE BEAN BAG SET 5CM

Perfect for throwing and catching games. Colourful soft feel vinyl with overlock stitching. Bean bags are filled with plastic pellets which are phthalate compliant. Set includes one Blue, Green, Red and Yellow. Size: 5cm

33197 5cm Set



BEAN BAG BALL SET

Soft leather feel. Lightweight and easy to throw and catch. Set of 6 rainbow colours. Size: 8cm diameter.

33096



BEAN BAG KIT

Assorted Colours:
 • 12 Flat bags - 15m x 10cm
 • 12 Cube bags - 5cm
 • 12 Cube bags - 7cm
 • 1 HART Super mesh bag - Mini

33199 Complete Kit



HERO FOOTBALL

Fluro Yellow with super soft feel.

33304 Length: 25cm



HERO SOCCER BALL

Fluro Blue with super soft feel.

33302 Diameter: 25cm



HERO BASKETBALL

Fluro Orange with super soft feel.

33303 Diameter: 23cm



HERO VOLLEYBALL

Fluro Green with super soft feel.

33301 Size: 5



PLAYGROUND BALL 5" OR 8"

Special two-ply construction for safety, soft handling and durability.

Diameter:

5 inch - 12.7cm Diameter: 8 inch - 20.32cm

100017 Blue 8"

100018 Yellow 8"

100019 Red 8"

100020 Green 8"

1000B5 Blue 5"

1000Y5 Yellow 5"

1000R5 Red 5"

1000G5 Green 5"



SUPALITE BALLS

Set of six brightly coloured, extra soft balls make it easy to learn to catch and throw. Cotton filled balls are super light so it won't sting which helps to reduce fear of getting hit. Diameter: 7cm.

33339

TUFF GATOR SKIN DODGEBALLS.

6020R Soccer Ball 213mm Red

6020B Soccer Ball 213mm Blue

6020G Soccer Ball 213mm Green

6020Y Soccer Ball 213mm Yellow

60216 210mm Set of 6 Colours

60226 160mm Set of 6 Colours



PVC SCHOOL BALLS

Inflatable rubber PVC balls with "School Ball" markings. Soft feel.

33260 Volleyball - Size: 5

33261 Soccer Ball - Diameter: 23cm

33262 Basketball - Diameter: 23cm

33263 Football - Length: 25cm



SOFTY BALLS

Vinyl coated non bounce foam ball with stitched panel outer shell. Gives the ball a real "Softy" feel.

33253 Size 3 - Diameter: 16cm

33254 Size 2 - Diameter: 14cm

33255 Size 1 - Diameter: 12cm



EXTREME SOFT BIG VOLLEYBALL

Ideal for training and developing young players, the super soft foam cover is gentle on the hands

20138 Oversize (25cm)



RAINBOW PLAYBALLS

Bright, multi-coloured three-ply rubber playballs. Low inflation only.

33289	Size: 8" Ball	\$14.00
33290	Size: 6" Ball	\$13.00
33291	Size: 5" Ball	\$12.00



HIGH BOUNCE BALL

Firm, dual coloured rubber 'high bounce' balls. Terrific for playground games like handball, or combine with a bat/racquet for hours of fun.

33264	Diameter: 60mm	Each \$7.00
-------	----------------	--------------------



RAINBOW MINI PLAYBALL SET SET OF 6

Inflatable playballs in a set of 6 colours. Each ball is 65mm in diameter. Colours include, red, yellow, blue, orange, purple & green.

33547	Diameter: 65mm	\$22.00
-------	----------------	----------------



NUMBERED PLAYBALL SET OF 6

Textured two-ply rubber playballs. Each different coloured ball is marked with a numeral and corresponding word in large bold black type. Low inflation only.

33288	Diameter: 210mm
-------	-----------------



TETHER BALL BUFFALO

Suitable for kicking practice without having to fetch the ball.

33248	Tether Ball
-------	-------------



COLOUR BALL SET SET OF 6

Colourful soft feel inflatable PVC playballs. Packaged as convenient sets of six, containing one ball of each colour - orange, yellow, blue, red, green & purple. Inflate to 100mm diameter.

33184	Diameter: 100mm
-------	-----------------



BUCKET OF BALLS 80 BALLS

Brightly coloured lightweight hollow plastic balls as used in indoor play pits. 80 balls in a handy bucket with lid. Balls are 75mm diameter.

33131	Diameter: 75mm
-------	----------------



SUPER SOFT BALL SET SET OF 4

Inflatable sponge rubber super soft balls. Low inflation to 20cm diameter. Soft, pliant 'grab' feel for young hands. Great bounce characteristics. Set includes soccer ball, netball, basketball and playball.

33092	Inflate to optimum psi of 0.1
-------	-------------------------------



CAPTURE THE FLAG KIT

Who can capture the flag first? The HART Capture The Flag Kit game involves using both the body and the brain. You must work together as a team to get the ball back in your half of the court without being tagged. The Capture The Flag kit has everything you need to play a large or small game. Whether you're playing indoors or outside, with your friends, family or classroom, this much-loved game will get everyone racing to win!

44016 Capture the Flag Kit

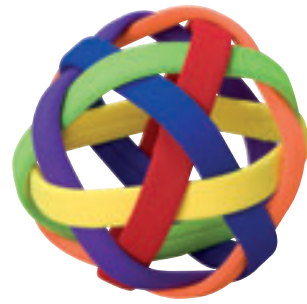

EASY CATCH BALL

This style of ball makes learning to catch so much easier. The ball doesn't bounce out of the hand and small fingers can grip it easily. The colourful nature of the ball also makes it simpler to track through the air. 160mm diameter.

33124 Easy Catch Ball



ALL ROUND GOAL

Shoot from every angle into this unique goal to create a range of exciting games! With a one metre diameter and adjustable heights (76cm, 89cm or 100cm), this goal is perfect for all ages. 4cm thick ABS collapsible tubing and nylon net makes it durable and easy to pack away. This goal comes with a bag for easy transport and compact storage.

44015 Note: Bulky Freight Item



PLAYBALL KIT

This kit contains balls with very different characteristics. The feel, bounce & size of each ball is unique. Watch the children's eyes light up as they experiment with each model ball. The vibrant colours will also stimulate their enthusiasm to 'have a go'!

33500 Playball Kit



SHUTTLE BALL HEAVY DUTY

Innovative new game which will burn your arms and shoulders and get your heart pumping. Expand the chest and extend the arms to send the ball down the rope to your partner. If they can time it right it will come back even faster! Will add an element of fun to circuits and group workouts. Includes two 3m ropes with handles and a 30cm diameter shuttleball.

33295 Shuttle Ball Heavy Duty

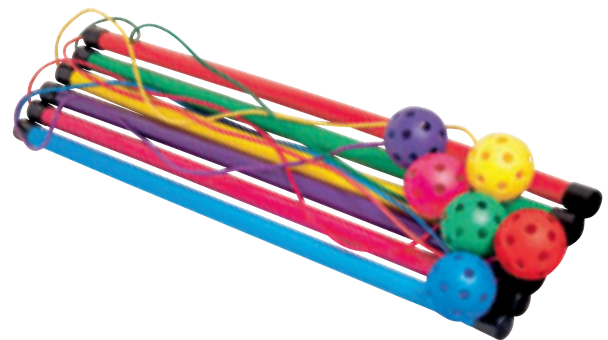

STICK O HOP

Novel way to develop co-ordination and jumping or skipping skills. Hold the stick and circle around so the ball starts to loop. You have to jump over the cord to allow the ball to keep looping. Go as fast or slow as you can handle! Each unit is made up of a lightweight 80cm stick with a 7cm wiffle ball attached to an 80cm cord. Set includes six Stick O Hops in six different colours.

33611 Stick O Hop



CROQUET SET DELUXE

- Alliance Croquet Set Deluxe
- Set Includes: Wicket, Stakes, Mallets, Balls & Carry Bag

GACS Alliance Croquet Set Deluxe



FOAM BOWLING SET

Modified version of ten pin bowling. Can be used on any level surface. Pins weighted for stability.

33070 10 Pins - 1 Ball

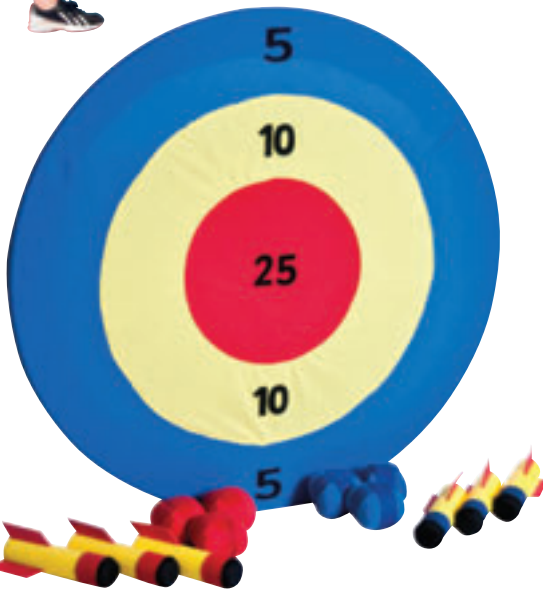

GIANT DART SET

A fun, safe target based game for all ages! The lightweight cloth target easily slides on to a 75cm hoop and has 3 different scoring zones. The lightweight darts and balls have velcro panels which stick to the target. Set consists of: 1 x Cloth Target (hoop sold separately), 6 x Foam Darts (3 x Red, 3 x Blue), 6 x Cloth Balls (3 x Red, 3 x Blue)

16354 Giant Dart Set



JUGGLING DIABOLO LARGE 1806

Loads of fun learning to spin, throw or catch the diabolo on the string. Helps develop coordination skills. Size: Large. Weight: 180g.

33155 Juggling Diabolo

Please visit www.slatertrellsports.com.au for up to date pricing.



JELLY SPIKE BALLS

Inflatable spike ball with a soft gel feel. Semi-transparent so you can almost see through them. 200mm diameter.

33080B	Blue
33080G	Green
33080P	Pink
33080Y	Yellow



PYRAMID BALLS

Improves hand/eye coordination due to erratic bounce. Invokes reaction to improve catching skills. Inflatable, pliant rubber. Pyramid shape. 160mm high.

33077B	Blue
33077Y	Yellow
33077R	Red
33077G	Green



SKILL BALLS

Brightly coloured mini ball with gloss finish. Ideal for kicking throwing or hitting.

33256B	Blue - Diameter: 140mm
33256Y	Yellow - Diameter: 140mm
33256P	Pink - Diameter: 140mm
33256G	Green - Diameter: 140mm
33256O	Orange - Diameter: 140mm



SEA ANEMONE

Bouncy soft touch feel. Great tactile experience. Made from rubber. Colours may vary.

33120S	Small - 100mm
33120	Large - 200mm



RAINBOW POM POM BALL

Made from rubber fibres, this is a lively and fun ball with a great feel. Ideal for beginners learning to throw and catch or tossing and juggling on the knee or foot. Wonderful tactile stimulation for little ones.

33186	Small - Diameter: 75mm
33161	Large - Diameter: 115mm



POM POM BALL SET SET OF 6

Made from rubber fibres, this is a lively and fun ball with a great feel. Ideal for beginners learning to throw and catch or tossing and juggling on the knee or foot. Wonderful tactile stimulation for little ones.

33160	Diameter: 75mm
-------	----------------



FOAM BELL BALL

The Foam Bell Ball is a soft foam ball with bells inside. This ball is great for blindfold games and learning how to catch and throw whilst developing teamwork and improve listening and spatial awareness skills.

Goalball is an ideal game to play with foam balls.

33210	Diameter: 20cm
-------	----------------



CHIME BALL SET SET OF 6

Soft yet resilient, self skinned foam ball with bells inside. The hole pattern allows sound to escape, making the bell easily audible.

33089	Diameter: 150mm
-------	-----------------



STREET SOCCER BALL

Extra tough synthetic Three-ply ball with an air retention, hi-tech bladder. Size 5.

9305	Size: 5
------	---------



SPIKE BALLS

Durable, inflatable with firm spike feel.

33239	Diameter: 200mm
33241	Diameter: 100mm



12 SIDED DICE SET OF 4

These inflatable & stackable dice are 100mm in diameter. Ideal teaching aid for counting & numeral recognition. Includes one blue, green, yellow & red dice.

33076	Diameter: 100mm
-------	-----------------



BIG FELT TENNIS BALL

Just like a real tennis ball but much bigger. Soft felt covering. Inflatable. Good bounce and easier to catch and track than a regular tennis ball.

33127	Diameter: 126mm
33564	Diameter: 210mm

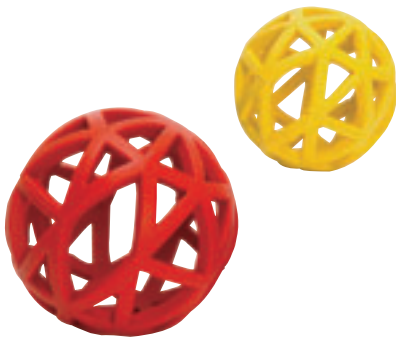

COBWEB BALLS

Moulded rubber 'spider web' ball. Squeeze it, bounce it, throw it, roll it, grab it. Low bounce ball retains its memory and provides some erratic bounce characteristics, making it fun for all ages and skill levels. Great for bowling type games. Colours may vary.

33093	Diameter: 70mm
33095	Diameter: 130mm



CATCH BALL

This innovative ball is inflatable & measures approx 30cm from spike to spike. A great way to develop focus, hand/eye coordination, memory, social function and maths with safety in mind. Each one of the six soft, vinyl catch ball spikes has a number on the tip and a different colour on each spike. Play point scoring and maths games or invent your own.

16050



COACHING BASKETBALL

Improve your shooting form with a "hands on" approach by learning how to correctly place your hands on the ball. Great training aid can be used for left or right handed shooters. Bright yellow ball is easy to identify for coaches.

4179	Size: 3
4178	Size: 5
4177	Size: 6



MINI SOCCER BALL

Quality synthetic cover, 12-panel inflatable fun ball. Diameter: 150mm

9284	White/Black/Fluro Green
9284B	White/Royal/Navy
9284C	White/Maroon/Gold



RUGBY COACHING BALL

Designed in conjunction with leading development coaches. Shows correct hand placement for carrying and passing. Soft touch foam ball with tough outer skin.

9151	Size: Mini
------	------------



SOFTY AUSTRALIAN RULES COACHING FOOTBALL

Innovative design to assist in performing the drop punt. Shows the beginner where to place hands to have the best possible grip before kicking.

Inflatable ball with a soft touch layer and tough outer skin..

9431	Size: 2 only
------	--------------



FOXTAIL BALL SET

Mega fun set of six multicoloured balls which can be thrown, kicked, twirled or slung. Try and catch them by the ball or by the tail! 10cm diameter balls with 80cm nylon tails. Balls are lightweight vinyl covered foam which are fantastic and safe for young children.

16356



CATCHTAIL BALL SET

SET OF 6

Twirl, kick, catch, throw or sling it! Lob this ball high into the air & catch it by the tail. Set of six balls with six different coloured tails. 7cm diameter balls with 1m long brightly coloured nylon tails.

33162 Ball Diameter: 70mm



CATCHTAIL BALL

Twirl, kick, catch, throw or sling it! Lob this ball high into the air & catch it by the tail. Best seller! So much throwing fun for children. 7cm diameter ball with 1m long rainbow nylon tail.

33185 Diameter: 70mm



SLIDING DISCS

Completely portable and versatile tool allows you to add another dimension to your workout. Engage your core and improve your stabilising muscles while performing any range of upper or lower body exercises. Suitable for use on most surfaces.

Diameter: 17.8cm.

6278 Each



SATURN RING BALL

Fun new design. Soft high density foam ball with tough outer skin for added durability.

33246 Diameter: 150mm



SWIRL BALL

Easy to grip, swirl design makes it easy to throw spirals every time. Made of closed cell dense foam.

33507 Length: 210mm



FOAM FITNESS DICE

Add variety to your warm ups and workouts with these fun dice. Roll the dice and then perform the exercise and number of reps that come up. Set contains 2 foam dice with a PU coating. The 10 sided dice is printed with numbers 2 to 20. The Exercise dice features 10 exercises: Burpee, Lunge, Push Up, Star Jump, Dips, V-Sits, Plank Hold, Squats, Sit Ups and Tuck Jumps. Size: 18cm

6717H Pair



VELCRO PADDLE BALL SET

Fun catch game to improve hand/eye coordination skills. The ball grips to the velcro face of the paddle. Consists of two paddles (22cm diameter) and one tennis ball.

16150 Paddle Diameter: 220mm

16151 Spare Balls: Pack of 2



NUMBERED SCARFBALL SET

Set of six brightly coloured balls are perfect for young children learning how to catch, throw or juggle. The lightweight, cloth balls are 5cm diameter with a 35cm scarf attached. The scarf acts to slow the descent of the ball with makes it easier to track and catch. Balls are numbered one to six so numeracy games can be easily incorporated.

16355

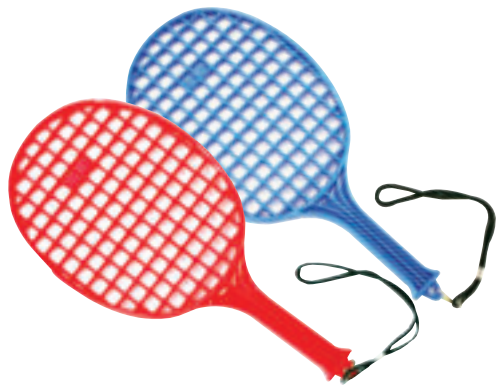

MINI AIR FLOW BATS

Lightweight, sturdy plastic racquet with wrist strap. Assorted colours.

33269 Length: 360mm



SMASH BALL SET

Consists of two lightweight racquets and two oversized shuttle balls. Racquets are 46cm long.

16052 Diameter: 460mm



SCOOP BALL SET

Great for cooperative participation in throwing and catching skills. Includes: 2 Scoops - 41cm long & 1 Wiffle Ball - 85mm diameter

16160 Colours May Vary



RAINBOW BAT SET

Brightly coloured durable lightweight plastic bats. Rainbow colours.

33252 Length: 700mm



MINI TENNIS RACQUET

Long handle air flow racquets. Total length: 48cm.

- 33268R Red - Length: 370mm
- 33268B Blue - Length: 370mm
- 33268G Green - Length: 370mm
- 33268Y Yellow - Length: 370mm



CUP CATCH SET SET OF 6

Develop hand-eye coordination with this classic game. Swing the ball in the air and catch it. The 7cm diameter ball is attached to the cup by a 78cm long bungy cord.

Set of six colours: red, orange, yellow, green, blue & purple.

33138 Set of 6



SHUTTLE BALLS

Shuttles for fun and play. Made from brightly coloured, durable plastic & rubber - These are just like the real thing!

16163A Length: 90mm Pair



FRISBEE GOLF DISC SET

Set of 3 Frisbee discs designed especially for Frisbee Golf. The Driver disc is designed for long range shots off the tee. Use the Mid-range disc for more accurate shots at the target and the Putter disc for very close range. Discs are 21cm diameter.

16141



FRISBEE GOLF BASKET

Very popular worldwide game suitable for all ages. Portable target is 132cm high and 60cm diameter. The twelve pieces of chain allow the frisbee discs to drop in to the basket. Includes 4 metal stakes to secure to ground.

16140

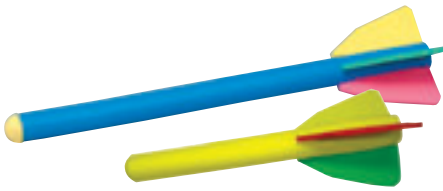

FOAM JAVELIN

Fantastic, safe and fun training and teaching aid for the sport of javelin. Suitable for all age groups, this javelin is made from lightweight, durable EVA foam and the brightly coloured tail fins make it fun to throw and to watch.

2401 Large - Length: 760mm
2402 Small - Length: 450mm



BULLNOSE FOAM JAVELIN

Moulded nose piece provides extra durability and realistic flight. Length: 78cm

2400 Length: 780mm

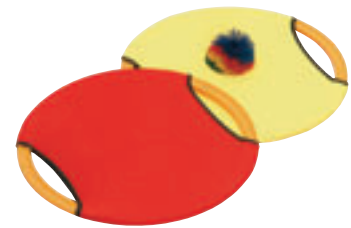

PADDLE RING SET

Fun way to develop hand/eye coordination. Can be used individually or with a partner. Brightly coloured neoprene fabric with easy grip handles. Set includes two paddles and one Pom Pom ball. Paddles 35cm diameter

33164 Large - Length: 370mm



FOAM PENGUIN BOWLING SET

Fun, colourful bowling set featuring ten solid foam penguins numbered 1-10. Each penguin is 23cm high and foam bowling ball is 21cm diameter. Includes carry bag and cardboard template for setting pins out correctly.

33568



CHIRPY RUBBER CHICKENS SET OF 6 - LARGE

The HART Rubber Chickens are a fun alternative to balls and can be used in many innovative games such as Chicken Olympics, Musical Chickens and Rob the Nest. The Rubber Chickens make a loud "Chirpy" sound when squeezed which is always a hit with the youngsters.

Size: 50cm long
33606 Set of 6



FRISBEE FLYER

Traditional lightweight, durable plastic frisbees. Colours may vary.

16128 Diameter: 230mm Each



SOFT TOSS FRISBEE SET

Lightweight, fun frisbee set which is great for young children learning how to catch and throw. Made of 5mm foam covered with vinyl. Set of 6 different colours. Size: 22cm diameter.

16364



SUPER FRISBEE FLYER SET

SET OF 6

This set consists of six colourful moulded plastic Super Flyers - one each blue, green, orange, purple, red and yellow. Super Flyers have great flying characteristics. Vary the game using different acceleration techniques. 230mm diameter.

16131 Diameter: 230mm



FOAM FRISBEE FLYERS

Closed cell high density foam frisbee with protective outer coating

- 33503B Blue - Diameter: 210mm
- 33503G Green - Diameter: 210mm
- 33503O Orange - Diameter: 210mm
- 33503P Purple - Diameter: 210mm
- 33503R Red - Diameter: 210mm
- 33503Y Yellow - Diameter: 210mm



FITNESS DICE SET SET OF 2

Set of two heavy duty fabric dice. Toss one & then the other to determine how many & which exercise will be performed next. Exercise choices are Jumping Jacks, Push Ups, Toe Touch, Arm Circles, Sit Ups and One Foot hops. 100mm square.

33074 100mm Square



FRISBEE CATCHER

Great for frisbee & target toss games. Can be used to catch frisbees, soft balls & bean bags. Height adjusts in three positions up to 1.53m high. Opening is 85cm wide x 31cm high. Lightweight for easy transportation. Base can be filled with water or sand to add stability.

16124



ALLIANCE AIR GOAL

A versatile target for flying discs, balls, bean bags and more. Lightweight, easy to transport and store and with 3 adjustable heights. Fill the base with sand or water for stability. Suitable for a range of modified games, inside or out.

GAAG



**RUBBER QUILTS
17CM SET OF 4**

Experience a burst of vibrant outdoor excitement with Rubber Quoits, a traditional throwing game that guarantees hours of fun. This exhilarating set features four multi-colored hoops, crafted from durable rubber for maximum resilience, ensuring endless entertainment for everyone.

GARQS4



RUBBER QUILTS

Easy to play for children. Heavy rubber base for stability with a 400mm high stake. Includes six 18cm rubber quoits and supplied with a handy mesh carry bag.

16121



RUBBER HORSESHOE SET

Made from durable weighted rubber, this set includes four horse shoes and two poles. The poles are mounted to a black rubber disc making this set ideal to use indoors or outdoors.

16117



MINI BOCCE SET

Fun, safe and colourful soft bocce set which is great for children of all ages. The bean bag style balls have a neoprene fabric shell which has a great soft feel and low bounce.

Set includes: 6 x Bocce Balls, 2 x Red, 2 x Blue, 2 x Black - 75mm diameter, 1 x Black Jack - 40mm diameter, 1 x Mesh Carry Bag

18695



FOAM HOPSCOTCH SET

Ten brightly coloured & numbered tiles fit together to play this traditional game both indoors & outdoors. Develop coordination, balance & manipulative skills. Great fun for all ages and can be assembled by preschool aged children. Supplied in a zippered storage/carry bag. Includes 4 discs. Size: 1.83m long x 61cm wide.

33520



MULTI NUMBER DICE

Lightweight, vinyl coated foam dice has six different brightly coloured sides. Each side displays a numeral, corresponding word and dot pattern. 130mm square.

33250



SKIP O HOP

This game helps build co-ordination and individual jumping skills. Set includes six Skip O Hops in different colours. Each hop unit is made up of a 14cm diameter ankle ring with a 7cm diameter wiffle ball attached by a 55cm long plastic cord.

33143



EGG & SPOON SET OF 6

Unlock a world of creative learning with our Egg & Spoon Set. Crafted from durable timber-look plastic, this set includes non-break eggs and long-handled spoons in 6 vibrant colors

GAESS



HOPSCOTCH GYM MAT

Fun addition for the kids! Printed gym mat with bright squares numbered 1 to 10. Foam mat provides a soft and safe surface for the kids to play on. Easy to clean, durable vinyl cover is great for use indoors or out. Size: 180cm (L) x 112cm (W) x 5cm (T).

10351 Note: Bulky Freight Item



BLINDFOLD SET SET OF 6

Set of 6 brightly coloured nylon blindfolds for all ages. Easy to wear for hide and seek type games such as; pin the tail, what shape is this? and many other sensory perception games. Uses are only limited by your imagination. Straps are elasticised and have velcro closures so one size fits all.

33084



FOAM DICE SET

A set of 8cm square, coated foam dice. Protective coating makes them easy to clean. Clear dice dots, 1 through 6, stamped on each colourful dice.

33075



20 SIDED DICE

Lightweight, solid, high density soft foam fitness dice with protective skin for brand new games ideas. Features numerals 1 through 20. Stands 120mm high.

33251



EGG & SPOON RACE SET DELUXE SET OF 6

Great for developing balance and motor skills. These colourful eggs and matching spoons for egg & spoon races makes it easier to track who has kept their egg balanced on their spoon.

Set includes six colours: red, orange, yellow, green, blue & purple. Spoons are 30cm long and eggs are 6cm long.

Spoons are made of hard plastic and the eggs are made of rubber.

33137



DINO EGG AND SPOON SET

Double the size and double the fun of the original! Jumbo sized eggs and spoons are great for a more visual version of the game. Eggs can be used as balls and bounce in unpredictable ways, great for developing motor skills. No mess, inflatable rubber eggs. Eggs: 20cm high.

33625



CAGE BALL

Perfect for large group play to develop coordination and co-operation. Made from sewn coloured panels of nylon and finished with a leather reinforced lace up opening. The bladder is lightweight and easy to inflate. Due to the nature and size of this ball, we recommend it is inflated with an electric compressor.

33570 Diameter: 1200mm



1-10 NUMBERED FLAT RUBBER FIELD MARKER DISCS

FNMD1 Numbered 1-10



11-20 NUMBERED FLAT RUBBER FIELD MARKER DISCS

FNMD2 Numbered 11-20



MOBILE BASKETBALL

Loads of fun team games can be had with this unique game pack. One team member straps the goal on to their back and the rest of the team have to get their colour balls in to the goal as quick as possible. Change the rules and have bonus points for a ball in the other teams goal or make up whatever rules you like!

Goals are made of lightweight mesh with pop up wire casing. Opening is 45cm diameter and the height is 35cm. Balls are super soft and lightweight and 75mm diameter.

Set Includes:

- 1 x Red Basket Bag
- 1 x Green Basket Bag
- 30 x Red Super Soft Balls
- 30 x Green Super Soft Balls
- 1 x Carry Bag

16353 Complete Set



SPACE BALL PACK

Use this kit as a basis for any number of fun games. Each of the six vests has a velcro panel that the soft lightweight balls easily stick to.

Develop teamwork, spatial awareness, coordination, colour recognition & mathematics skills using retrieval games, relays or treasure hunts. The possibilities are only limited by your imagination!

Contents:

- 6 x velcro vests - 1 x Blue, Green, Red, Yellow, Purple, Orange
- 60 balls - 6 of each colour numbered 1 to 10
- Carry Bag

16352 Complete Set



JUMPING SACK NYLON SET OF 6

Sturdy nylon 'sack' bags for jumping activities. Each set displays numerals, corresponding words and dot patterns. Jumping bags are made for sack racing, have two handles per bag & are double stitched for durability.

33082	Preschool to Lower Primary	Length: 60cm
33083	Upper Primary to Secondary	Length: 88cm

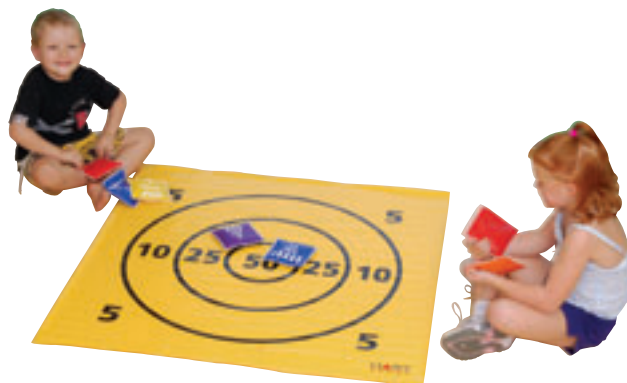

FLOOR TARGET

Ideal alternative throwing activity. Made from heavy duty vinyl, the mat is easy to roll up. Suitable for inside & outside play. Bean bags not included.

33524	Size: 1m x 1m
-------	---------------

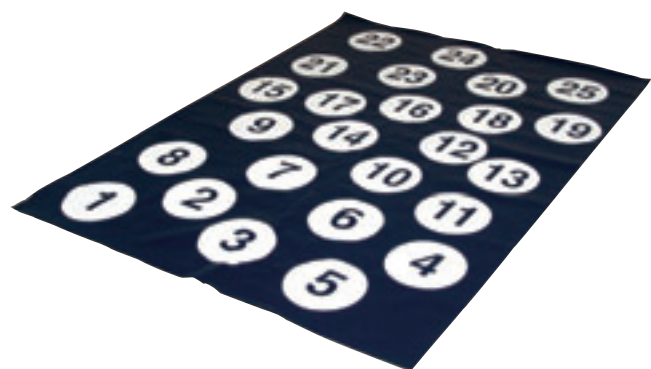

NUMBERED MAT

Made from heavy duty nylon. Easy to roll up. Ideal for throwing activities. Numbered 1 - 25. Each circle: 250mm diameter. Size: 212cm long x 153cm wide.

33525



TWO SIDED TARGET FACE

Great for throwing games with bean bags. Both sides have a face configuration made from different shapes. Behind each shape is a catch net. Can be disassembled for easy storage. Comes with carry bag. Each side is 94cm x 71cm.

33126



PORTABLE PASSING TARGET

Excellent training aid for both AFL handball and Rugby passing drills. Bulls-eye flap allows ball to pass through target. Easy to assemble. Frame is made from 40mm PVC pipe with heavy duty nylon connectors. Rubber bases are 2.5kg each. Vinyl target is 115cm x 115cm. Overall height of the set is 165cm. Includes a handy carry bag.

44012	Note: Bulky Freight Item
-------	--------------------------



JUMPING MAT

Measures horizontal jumping distance. Ideal for standing jump tests. Cushioned PVC mat with non-slip base. 3m in total length and 80cm wide. It is permanently marked in yellow at 1m and then at 5cm intervals to the end.

33081



BARRICADE

Add an extra element to your games with the HART Barricade. Use these versatile, lightweight walls during play as barriers between two teams or mark out marshalling areas. Space Ball players can hide behind these walls like a real game of skirmish.

Size: 195cm (w) x 102cm (h).

16345



TIP IT TOWER GAME KIT

Two teams race the clock to tip their teams ball off the tower the most times! Includes: Tip It Tower x 1 Pair, Super Skin Softi Balls x 1, Super Skin Softi Ball Red x 1, Foam Flyers x 10, Foam Flyer Red x 10, Marking Line x 1, Marking Line Red x 1

16137



Scooter Boards
Not Included.

SCOOTER VELCRO CATCHERS

Large velcro panels on these PVC vertical frames provide a sticky target for the HART Scooter Launch Balls (33-590). Moving targets are harder to hit so plenty of fun will be had throwing or launching balls at these. These goals attach to HART Double Scooter Boards (33-580) with locking pins to keep them in place. Pair includes: 1 x Blue and 1 x Red target.

33589

Pair



Scooter Boards
Not Included.

SCOOTER NET CATCHERS

Large vertical frames provide a big fun goal for all kinds of mobile target games. Combine with lightweight foam balls or foam frisbees for heaps of fun. These goals attach to HART Double Scooter Boards (33-580) with locking pins to keep them in place. Height: 132cm Goal size: 56cm x 35cm

33588

Pair



SCOOTER BOARDS SMALL

Ideal for mobility skills. Can be used to develop bi-lateral co-ordination, balance and kinesthetic awareness. Sturdy moulded plastic construction. Two handles. Four swivel wheels. 300mm square. (Max weight capacity is 80kg).

33073B	Blue - 30cm Square
33073G	Green - 30cm Square
33073R	Red - 30cm Square
33073Y	Yellow - 30cm Square



SCOOTER BOARDS LARGE

Ideal for mobility skills. Can be used to develop bi-lateral co-ordination, balance and kinesthetic awareness. Sturdy moulded plastic construction. Two handles. Four swivel wheels. 400mm square. (Max weight capacity is 80kg).

33512B	Blue - 40cm Square
33512G	Green - 40cm Square
33512O	Orange - 40cm Square
33512Y	Yellow - 40cm Square
33512P	Purple - 40cm Square
33512R	Red - 40cm Square



DOUBLE SCOOTER BOARDS

This 6 wheel double scooter is big enough for lay down surfboard style paddling or two children to sit or kneel and ride together! Features 3 specialised holes for all the fun HART Scooter attachments. Max weight capacity: 100kg

33580B	Blue - 71cm x 35cm
33580G	Green - 71cm x 35cm
33580Y	Yellow - 71cm x 35cm
33580R	Red - 71cm x 35cm



SCOOTER PADDLES

Allows children to learn new ways to manoeuvre. Helps to develop upper-body strength and coordination skills. Heavy-duty PVC with easy-to-grip foam handles and non-marking rubber tips. Size: 25mm diameter, 275mm long.

33552R	Red	Pair
33552Y	Yellow	Pair

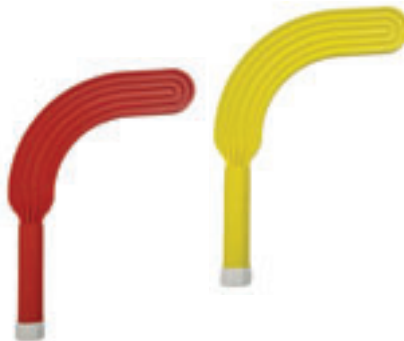

ALLIANCE SCOOTER HOCKEY STICK

GASBHS03	Red
GASBHS06	Yellow



SUPER SOFT LAUNCH BALLS

Super soft and lightweight cloth balls designed for use with HART Scooter Ball Launcher (33-586) and HART Scooter Velcro and Net Catchers.

Set includes: 10 x Blue, 10 x Red, 1 x Mesh Carry Bag. Ball diameter: 75mm
33590



Scooter Boards Not Included.

SCOOTER BASKETBALL GOALS

Create fun moving targets and dynamic basketball style games. Goals are 122cm high and fit in to the HART Double Scooter Boards (33-580) with locking pins for a secure fit.

Goal opening is 31cm x 24cm.
33587 Pair



Scooter Boards Not Included.

SCOOTER BALL LAUNCHERS

Launching ultra soft balls at targets, pins, goals is guaranteed fun! The number of launching and catching games you can play on the HART Double Scooters is limited only by your imagination.

Compatible with HART Double Scooter Boards only (33-580)
HART Sport recommends only the HART Launch Balls (33-590) are used with this product for safety and ease of use.

Scooter Boards Not Included.
33586 Size: 42cm (H) x 42cm (W) Pair

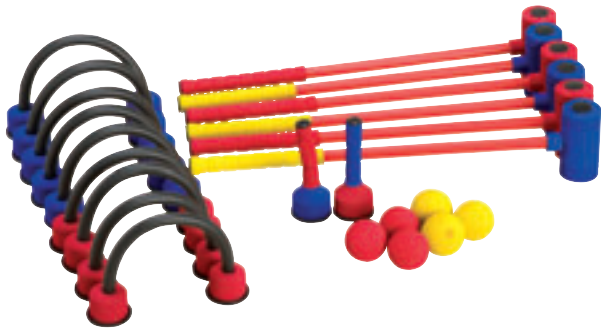

FOAM CROQUET SET

Game can be set-up anywhere - indoors or outdoors. Unique weighted foam-covered wickets stay upright while still remaining soft and flexible. Includes 6 mallets (670mm L), 6 balls (62mm diam), 9 wickets, 2 stakes and a vinyl storage bag with handle.

33064



CONNECTA BALANCE PATH

Walk the bridges and stepping stones as you create and explore new pathways. Great for learning how to balance and adding some fun to obstacle courses. Six beams and six circular pads connect at multiple points to create any range of courses. Anti-skid bottom allows for use on any surface.

Beams: 60cm (L) x 10cm (W) x 5cm (H)
Pads: 30cm (D) x 5cm (H)

33425



SOCCER HI HOPPER

Bouncing is even more fun on the new Soccer Ball Hi Hopper! Great for developing balance and strength and improving children's coordination. The closed handle makes gripping the hopper easier. 40cm Diameter.

Maximum User weight: 60kgs

33008



BASKETBALL HI HOPPER

Bouncing is even more fun on the new Basketball Hi Hopper! Great for developing balance and strength and improving children's coordination. The closed handle makes gripping the hopper easier. 50cm Diameter.

Maximum User weight: 60kgs

33009



SWISS BALLS

Great all round swiss ball for all types of strength, flexibility, balance, rehabilitation & core training exercises. Ridged finish for extra grip.

- 33314 38cm
- 33315 55cm
- 33316 65cm
- 33317 75cm



ROCK'N'HOPPER

Improve your fitness, skill and sense of balance. Reinforced plastic platform with an inflatable durable rubber ball. Size: 37cm wide x 29cm high.

33090 Weight limit is 35kg.



ELLIPTICAL JUMP BALL

The peanut shape makes this jump ball easier to sit on. Size: 60cm(L) x 40cm diameter.

33013



MOON BALL

Large playground ball with high bounce. Textured grip to make catching and throwing easy. Inflatable. 390mm diameter

33279



FROG FEET

Great fun for relay races. Helps build leg strength and improve balance. Made of durable EVA foam with adjustable length foam padded handles.

33141



TIGER FEET

Another fun way to develop balance and coordination. Larger surface area and colour paw print makes these steppers easy and appealing to use.

33247



BALANCE DISC 34CM

Extremely versatile, compact and portable training tool. Excellent for balance, strengthening and rehabilitation exercises.

Build core strength using one or two cushions for push ups, squats and lunges. Exercise difficulty can be adjusted by increasing or decreasing the amount of air pressure in the cushion. One side has pimple finish.

Size: 34cm diameter. Colour: Green

2044

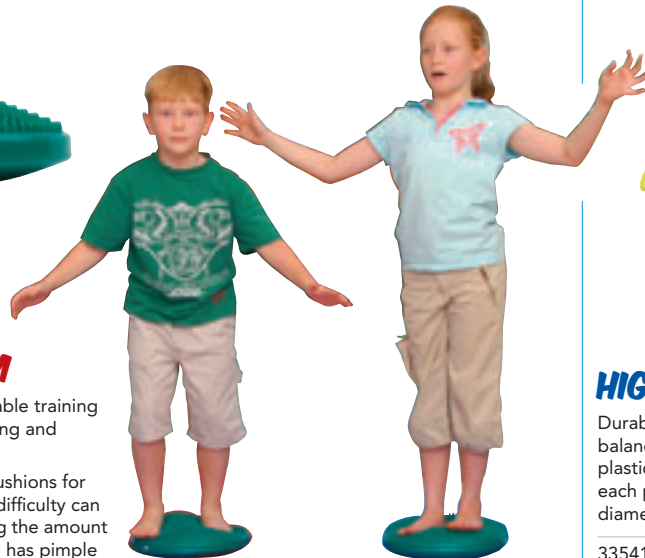

HIGH STEPPER

Durable, economical & loads of fun. Develop balance & coordination on these thick, moulded plastic balancing steps. Strong rope attached to each plastic stepper. Each step is 13cm high, 11cm diameter. Rope is 54cm in folded length.

33541



MINI BALANCE TRAINER

The Mini Balance Trainer is excellent for balance training, rehabilitation and sports conditioning. It features a non-slip base and can be used curved or flat side up. Includes pump.

Diameter: 45cm. Height: 15cm when inflated. Weight limit: 135kg

2048



LOLO BALL SET

Race your friends on these new colourful Lolo Balls. Great for improving balance and fitness. Reinforced plastic platform with an inflatable durable rubber ball.

38cm diameter disc. Maximum User weight: 60kgs

33010



ECO BALANCE CUSHION

High quality balance disc constructed completely of non-toxic materials. PVC, Phthalate, Latex and Chloride Free!

The larger diameter and height allows for a huge variety of exercises as both hands or feet can be comfortable placed on the cushion. Heavy duty feel with circular ribbing on one side and pimple grip on the other. Inflation can be adjusted to suit individual needs.

2049 Diameter: 36cm



FOOT PODS

This large inflatable dome creates an instable and difficult surface for balance training. Can be used flat side down or up for varied levels of skill. Single or multiple domes can be used for a great variety of exercises. Pimple domed surface provides grip for the feet to prevent slipping. Diameter: 33cm. Height: 17cm.

- 2047B Blue
- 2047G Green
- 2047R Red
- 2047Y Yellow



BALANCE BUG SET

Balancing is even more fun with the Balance Bug Set. Roll the bugs on their back to practice balance and weight transfer or tip the bug back on its feet to step from one to the next. Each piece is covered in a highly durable UV Stabilised vinyl which can be used indoor or outdoors. Large Piece (1): 120cm (L) x 50cm (W) x 14cm (H). Small Piece (4): 30cm (L) x 50cm (W) x 14cm (H)

33416 Note: Bulky Freight Item



6 WHEEL PEDAL ROLLER

Can be used by young and old. Stand on the platforms and begin walking. The up and down effect improves balance, coordination and reaction. Easy to learn. Supports up to 100kgs. 6 x 210mm wheels.

33167



ROUNDERS BAT

Wooden bat in cricket bat shape. Approximately 45cm in length. Great for school PE games

33276

BALANCE SNAKE

Carefully tip toe your way across the snake's back. Great for adding extra fun to motor skill activities. Perfect tool for improving balance and coordination. 1.5m long and 9.5cm diameter.

33614



3 LEG RACE BANDS

Great new product for the traditional three legged race. Easily attached with strong velcro fastening. 50cm x 5cm. Two per pack.

33140

Pair



FOAM BALANCE BEAM

Super soft foam to improve balance and proprioception. Can be used narrow or wide side up depending on level of ability. Place multiple beams end to end or in any formation to suit your needs.

2060 Size: 95cm x 6cm x 11/19cm

HALF FOAM ROLLERS

These D shaped rollers provide a more stable base than the the full round rollers. Ideal for balance exercises, static stretching and myofascial release. Foam Density/Hardness : 50/35

2058 90cm (L) x 15cm (W) x 7.5cm (H)
 2059 30cm (L) x 15cm (W) x 7.5cm (H)



BALANCE BEAM

Timber construction. 260cm long x 14cm wide beam rests on two wooden stands, approx 10cm from ground. Versatile beam can be used either flat or on the side.

33051 Note: Bulky Freight Item



BALANCE BOARDS SET SET OF 4

Ideal for balance laterality & visual motor control. There are four varnished wooden boards to a set & each one of the four boards comes with a different shape under it. Shapes include a cube, a rectangular prism, a prism with a curved edge & a prism with a trapezium edge. Individual board dimensions are 40cm x 40cm.

33065



HOPSCOTCH MAT

Made from heavy duty vinyl, the mat is easy to roll up and take anywhere. Suitable for use indoors or outdoors. Size: 305cm x 110cm.

33575



ROLLOUT LINE - 5M

Yellow PVC line that can be rolled out for quick and easy game set ups or line markings. Can be used indoors or outdoors and cut to any length desired. The weighted line is 3mm thick and 38mm wide and designed to roll out flat on any hard surface.

44205 5m Roll



**CRAWLING TUNNEL
58.5CM DIA X 270CM LONG**

Explore endless adventures with our 58.5cm diameter X 270cm long Crawling Tunnel. Crafted from durable nylon with reinforced canvas, it's perfect for primary schools, PMP activities, and early learning programs. Collapse it for effortless storage, secure it with Velcro tabs, and watch it become the highlight of your obstacle course.

GACT



LIGHTWEIGHT CRAWLING TUNNEL

One colour nylon tunnel. Lightweight and easy to manage. Ideal for indoor or outdoor use. Collapses for storage and transportation. Size: 2.75m long x 58cm diameter.

33531



TEAM PARTNER CHUTE

The HART Team Partner Parachute is made up of 6 different coloured pieces that can be used individually or attached together with velcro to make one large parachute. Parachute play is an enjoyable way for children to develop motor coordination, team play and collaborative decision making skills. As children become more confident you can add additional balls and games to keep them enticed.

A handle on each corner makes it easy to use.

Each piece is 1m(L) x 75cm(W).

100073 Set of 6



CATERPILLAR

The HART Caterpillar is used to enhance team work and is made from a tough durable vinyl. This product has double stitching for extra strength.

33491



SEE THRU CRAWLING TUNNEL

PLASTIC 2.75M

Double stitched & reinforced clear plastic tunnel, makes for fun chase & escape games. Ideal for indoor or outdoor use. Collapses for storage and transportation. Size: 2.75m long x 57cm diameter.

33530



RAINBOW PARACHUTES

Multi-coloured sturdy nylon parachute. Ideal for group play & developing motor coordination. Stitched handles & mesh porthole. Comes in convenient cloth carry bag.

33108 Diameter: 7m with 24 Handles

33109 Diameter: 6m with 18 Handles

33110 Diameter: 4m with 12 Handles



TARGET PARACHUTES

Group activity, nylon, multi-coloured parachute. Features numbers as dots, numerals & words. Can also be used for shape & colour identification. Central mesh porthole. Includes handy carry bag. Size: 3.66m diameter - 12 handles.

33113 Dia: 366cm with 21 Handles



RIPPLE PARACHUTES

Great parachute that requires cooperation and coordination to make ripples to roll a lightweight ball into the built-in pockets or flick a ball into the air. Handles on each corner makes it easy to grip. 430cm x 118cm

33107



RHYTHM RIBBON SET

SET OF 6

Each set comprises six individual, brightly coloured satin-type 'double' ribbons with swivel end & coloured baton. Play at being a real Rhythm Gymnast or simply have some great fun!

33527 Length: 90cm



WRIST RIBBONS SET OF 12

These colourful ribbons slide on to children's wrists, keeping their hands free to dance, wave, clap and more. Ribbons are 70cm long.

33555 Length: 90cm

CUSTOM TEAMWEAR

**YOUR TEAM OR CLUB CAN NOW
LOOK LIKE TRUE PROFESSIONALS.**

Slater-Gartrell Sports clothing range offers a combination of high performance fabrics in conjunction with a comfortable and functional fit to meet a player's match and training kit requirements at every level.

Slater-Gartrell Sports understands the needs of teams and our range of high performance stock match shirts, training wear and leisure garments combined with an extensive range of customised options cater for every scenario.

Our specialised design team can assist and advise on every aspect of incorporating your specific school, club or university colours onto any garment.

Our embroidery and printing facilities allow quick turnaround on stock items which can all be embellished with your club logo, numbers and or sponsor logo.



**SLATER-GARTRELL
SPORTS**



SMALL BLOCK

33460 (230 x 480 x 240mm)



LARGE BLOCK

33458 (910 x 480 x 240mm)



SMALL CYLINDER

33467 (465 x 235mm)



LARGE CYLINDER

33465 (900 x 405mm)



TWO STEPS

33486 (465 x 505 x 475mm)



THREE STEPS

33485 (605 x 755 x 605mm)



SMALL WEDGE

33476 (905 x 450 x 300mm)

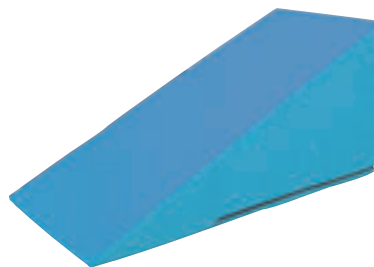

MEDIUM WEDGE

33475 (1200 x 600 x 600mm)

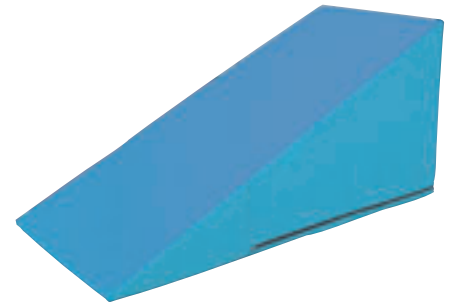

LARGE WEDGE

33477 (1800 x 400 x 900mm)



STEP FOR WAVE

33456 Steps for Wave includes velcro

Note: Bulky Freight Item

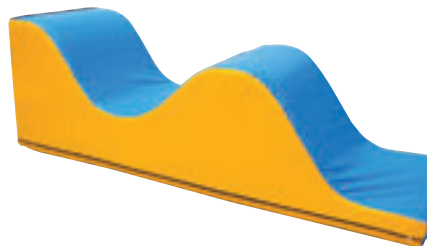

WAVE

33455 (1800 x 600 x 600mm)

Note: Bulky Freight Item



BALANCE TRAINER BEAM

This product provides children with an excellent way to improve their balance. It is made from a high density foam that weighs 8kg. The extra wide base measures 450mm and is 1200mm long. The top measures 150mm where the kids walk.

33490 Note: Bulky Freight Item



COLLAPSIBLE BENCH

Instant bench, sets up in seconds, use anywhere anytime.

9835 2.6m x 45cm



FOAM JUGGLING RINGS

Brightly coloured foam rings. 25cm diameter

33085 Set of 4

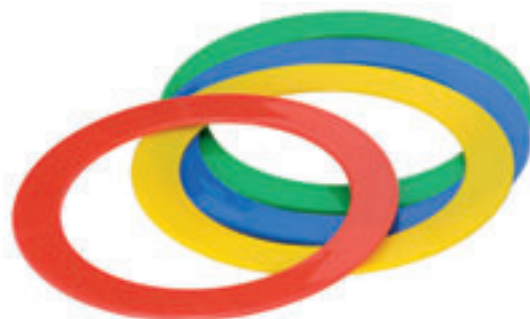

JUGGLING RINGS

Made from 4mm thick durable plastic in four bright colours. 24cm diameter.

33159 Set of 4



JUGGLING PLATES

Highly durable, plastic plate moulded with a peak centre. Set includes four plates in bright colours and four spinning sticks. Great for hand/eye co-ordination. Plates are 23cm diameter.

33157 Set of 4



MULTI COLOURED JUGGLING BALLS

Stitched bean bag style multi-coloured juggling ball. Easy to juggle as they do not bounce much out of the hand. 75mm diameter.

16173 Set of 4



JUGGLING BALLS

Solid sponge balls with a textured surface. 60mm diameter.

33156 Set of 4



DEVIL STICKS

The two yellow "hand sticks", are used to manipulate the "devil stick" so it bounces back and forth or flips in the air. The "devil stick" is coated in soft foam-rubber to improve grip and reduce noise. Set includes two hand sticks (590mm) and one devil stick (620mm)

33165 Set



BUM BAG FIRST AID KIT

Includes: CPR pocket card 114 x 84mm, Conforming bandage 7.5cm x 1.8m, 2 x Crepe medium bandage 7.5cm x 2m, Emergency thermal blanket, Latex gloves 1 x pair large, Magnifier plastic, Non Adherent 5 x 7.5cm single, Plastic bag 125 x 205mm Med clip seal plain, Plastic strips 19x72mm 10 pack, Safety pins 12 pack assorted, Scissors 11cm long, Splinter probe, Tape paper 1.25cm x 5m porous, Trafalgar first aid pamphlet, Triangular bandage 110 x 155cm, Tweezers, Wound dressing No 15, 2 x Wound wipe with Cetrimide Single.

3000 Bum Bag First Aid Kit



SMALL FIRST AID KIT

Includes: 1 x Bandage Crepe 5cm, 1 x Bandage Crepe 7.5cm, 1 x Tape Hypoallergenic 1.25 x 9m, 1 x Swabs Gauze 7.5cm 3 PK, 2 x Pad Combine 10 x 10cm, 2 x Pad Non Adherent 7.5 x 10cm, 1 x Pad Eye Sterile, 5 x Swabs Alcohol each, 1 x Scissors Stainless Steel Sharp/Blunt 12.5cm, 1 x Forceps Stainless Steel Splinter Pointed 12.5cm, 1 x Pins Safety 12 PK, 1 x Notepad & Pencil, 2 x Saline Eye & Wound Irrigation 15mL, 1 x Strips Adhesive Plastic 50PK, 1 x Swab Antiseptic 10PK, 1 x Burnaid Sachet 3.5g, 1 x Stingoes Sachets 3ml 5PK, 1 x Glove Disposable Nitrile Large Pair, 1 x Guide First Aid Quick Reference, 1 x Resuscitation Protection Shield.

3001 Small First Aid Kit



INSTANT ICE PACK

3010



RE-USABLE HOT & COLD COMPRESSION

3011



MEDIUM FIRST AID KIT

Includes: 1 x Adhesive strips plastic x 50, 1 x Plastic specimen bag, 1 x Bandage crepe 5cm, 2 x Bandage crepe 7.5cm, 2 x Bandage crepe heavy duty 10cm, 2 x Triangular bandage 110 x 110cm, 1 x Emergency shock blanket, 2 x Burn Relief sachet 3.5g, 1 x Forceps Stainless Steel Splinter pointed, 2 x Disposable Nitrile gloves large, 1 x Emergency Guide First Aid, 1 x Notepad and pencil, 2 x Pad Combine 10 x 10cm, 2 x Sterile eye pads, 2 x Non Adherent pads 7.5 x 10cm, 1 x Safety pins 12pack, 2 x Primapore dressing 8.3 x 6cm, 1 x Resuscitation protection shield, 5 x Saline eye & wound irrigation 15ml, 1 x Stainless Steel scissors sharp/blunt 12.5cm, 1 x Splinter probe disposable 5's, 1 x Sting & Itch relief sachet 3ml 5 pack, 1 x Swab Antiseptic 10 pack, 1 x Swab Alcohol 10 pack, 3 x Swabs Gauze 7.5cm 3 pack, 1 x Tape Hypoallergenic 2.5cm x 9m.

3002



LARGE FIRST AID KIT

Includes: 1x Adhesive strips fabric x 50, 1 x Adhesive strips plastic x 50, 2 x Plastic specimen bag, 1 x Bandage crepe 5cm, 2 x Bandage crepe 7.5cm, 2 x Bandage crepe heavy duty 10cm, 2 x Triangular 110 x 110cm, 2 x Emergency shock blankets, 1 x cold pad instant disposable, 1 x dressing length adhesive 6cm x 1cm, 1 x universal dressing small, 1 x forceps stainless steel splinter pointed, 5 x disposable nitrile gloves large, 1 x emergency first aid guide, 1 x notepad & pencil, 2 x pad combine 10 x 10cm, 2 x pad combine 10 x 20cm, 2 x pad eye sterile, 2 x pad non adherent 5 x 5cm, 2 x pad non adherent 7.5 x 10cm, 1 x safety pins 12pack, 5 x primapore dressing 8.3 x 6cm, 1 x resuscitation protection shield, 10 x saline eye & wound irrigation 15ml, 1 x scissors stainless steel sharp/blunt 12.5cm, 1 x sheers trauma scissors 14cm, 1 x splinter probes disposable 5pkt, 2 x sting & itch relief sachet 3ml 5pkt, 4 x sunscreen sachets 30+ 10ml, 1 x swab antiseptic 10pkt, 1 x swab alcohol 10pkt, 3 x swabs gauze 7.5cm 3pkt, 1 x tape hypoallergenic, 1 x tape zinc oxide 2.5cm x 5cm.

3003

RESUSCITATION EQUIPMENT

5403 Little Anne Manikin
5400 Manikin Wipes - Box of 50
5401 Chlorhexidine Solution
5402 Disposable Oxi Mask



ARCTIC HEAT COOLING VESTS

The Arctic Heat Cooling Vest is a revolutionary product designed to counter the harmful effects of heat stress. It is fast becoming an essential piece of sporting equipment for athletes seriously seeking a competitive edge.

3040BS Small - Blue
3040BM Medium - Blue
3040BL Large - Blue
3040BXL XL - Blue
3040B2XL XXL - Blue
3040B3XL XXXL - Blue
3040B4XL XXXXL - Blue
3040B5XL XXXXXL - Blue



TOTAL RESISTANCE SYSTEM
PORTABLE GYM & PILATES SYSTEM

A "gym-in-a-bag", the PTP Total Resistance System is the ultimate set to train both upper and lower body and achieve muscular strength, body toning, fat burning and flexibility. It allows you to target arms, shoulders, chest, back, abs and legs and lets you recreate all the top workouts at home, in a park, at the beach or on travels. Choose from no less than 31 resistance combinations.

Includes: 5 PowerTubes, Power Handles, Ankle Straps, Door Anchor, Outdoor Anchor & Carry Bag.

PTP001



RESISTANCE SYSTEM
PORTABLE GYM & PILATES SYSTEM

Build incredible full body strength, targeting your biceps, triceps, shoulders, chest, back, core, glutes and legs. Whether you're new to resistance training or a seasoned athlete, you'll find just the right level of challenge with no less than seven resistance combinations to choose from.

Includes: 3 PowerTubes, Power Handles, Door Anchor & Carry Bag.

PTP002



POWERTUBE PLUS
RESISTANCE TUBE & DOOR ANCHOR

Whether your goal is to achieve fat burning, muscle building or body toning, the PTP PowerTube+ is the ultimate fitness tool. Highly portable, it can target any muscle group: arms, shoulders, chest, back, abs, glutes and legs. Place your door anchor through a door at any height to recreate all the top gym workouts anywhere and anytime.



ULTRALIGHT 2.2kg
RESISTANCE TUBE & DOOR ANCHOR

PTP003



LIGHT 5.5kg
RESISTANCE TUBE & DOOR ANCHOR

PTP004



MEDIUM 7.5kg
RESISTANCE TUBE & DOOR ANCHOR

PTP005



HEAVY 12.4kg
RESISTANCE TUBE & DOOR ANCHOR

PTP006



ULTIMATE 14.9kg
RESISTANCE TUBE & DOOR ANCHOR

PTP007



ANKLE STRAPS

PTP008



POWER HANDLES

PTP009



OUTDOOR ANCHOR

PTP010



INDOOR ANCHOR

PTP011



POWER TUBE

ULTRALIGHT 2.2kg

PTP012



POWER TUBE

LIGHT 5.5kg

PTP013



POWER TUBE

MEDIUM 7.5kg

PTP014



POWER TUBE

HEAVY 12.4kg

PTP015



POWER TUBE

ULTIMATE 14.9kg

PTP016



POWER TUBE

EXTREME 22.4kg

PTP017



MEDIBAND

FLAT RESISTANCE BAND

By delivering progressive resistance training, the PTP MediBand is the most effective way to add challenge to basic exercises and condition muscles for functional and sports specific movements. It can be used for a range of purposes: muscular strength, stretching and flexibility, muscle toning or motor coordination.



ULTRALIGHT 4.2kg

FLAT RESISTANCE BAND

PTP018



LIGHT 5.8kg

FLAT RESISTANCE BAND

PTP019



MEDIUM 6.5kg

FLAT RESISTANCE BAND

PTP020



HEAVY 8.8kg

FLAT RESISTANCE BAND

PTP021



ULTIMATE 9.6kg

FLAT RESISTANCE BAND

PTP022



MICROBAND
LATEX RESISTANCE LOOP

Designed for exercises that require a small range of motion, the PTP MicroBand is a compact and effective tool to increase strength and stability in your upper and lower body. By performing hip/glute activation and shoulder stabilisation exercises, it will help you leverage your performance and prevent injuries.



ULTRALIGHT 4.2kg
LATEX RESISTANCE LOOP

PTP023



LIGHT 5.8kg
LATEX RESISTANCE LOOP

PTP024



MEDIUM 6.5kg
LATEX RESISTANCE LOOP

PTP025



HEAVY 8.8kg
LATEX RESISTANCE LOOP

PTP026



ULTIMATE 9.6kg
LATEX RESISTANCE LOOP

PTP027

MICROBANDX
WOVEN RESISTANCE LOOP

Designed with durability and convenience in mind, the PTP MicroBandX allows you to activate your glute-hip complex and increase power in your legs with resisted squats, hip abductions/adductions, leg extensions and more. By effectively recruiting your lower body muscles, it will help you build the necessary strength to better support your joints and reduce your risk of injury.



LIGHT
WOVEN RESISTANCE LOOP

PTP028



MEDIUM
WOVEN RESISTANCE LOOP

PTP029



HEAVY
WOVEN RESISTANCE LOOP

PTP030



SUPERBAND
PULL-UP ASSISTANCE LOOP

The PTP SuperBand will assist you to perform pull-ups, chin-ups and dips for the first time or perform more reps than ever before. It works by helping you lift your own body weight. The thicker the SuperBand, the more leverage you will get and the easier it will be to achieve pull-ups/chin-ups/dips. You can also use it to run against the resistance and increase your strength, speed and agility.



LEVEL X1 2.3-6.8kg
PULL-UP ASSISTANCE LOOP

PTP031



LEVEL X2 11.4-22.7kg
PULL-UP ASSISTANCE LOOP

PTP032



LEVEL X3 22.7-34.1kg
PULL-UP ASSISTANCE LOOP

PTP033



LEVEL X4 45.4-54.5kg
PULL-UP ASSISTANCE LOOP

PTP034



LEVEL X5 54.5-79.5kg
PULL-UP ASSISTANCE LOOP

PTP035



PULL-UP BAR
HEAVY-DUTY ADJUSTABLE BAR

With the PTP Pull-Up Bar, train your back, shoulders and arms simultaneously. You can set it up at three different heights to quickly shift exercises thanks to the three pairs of mounting brackets included. Perform pull-ups, chin-ups, dips, inverted rows and even sit-ups and push-ups, and take your fitness to the next level.

- Unique ergonomic handle design for improved grip and reduced stress on hands and fingers
- Adjustable to three different door heights for maximum exercise versatility
- Fits any standard wooden door frame (62 cm up to 85 cm) and easy to assemble
- 3 x pairs of mounting brackets included

PTP036



PILATES BALL
SMALL & MEDIUM SOFT BALLS

Learn to master the Pilates method with the PTP Pilates Balls. Suitable for all ages, you can use them in leg and abdominal exercises or as a supportive base to improve your body's alignment. The exercises included have been carefully developed by a Pilates expert for improved flexibility and motor coordination.

PTP037



STABILITY DISC
INFLATABLE BALANCE TRAINER

Elevate your workouts by adding an element of instability and improve your core strength, balance, coordination and posture. The unstable platform forces the body to react as an integrated system, engaging the abdominal, pelvic floor and back muscles to stabilise the joints. Simply change the level of inflation for more or less stability and challenge.

PTP038



COREBALL 55 CM
GYM BALL

The Pearl Violet PTP CoreBall features a 55 cm diameter, which makes it suitable for individuals between 140 cm (4 ft 7) and 165 cm (5 ft 4). Specifically designed to develop your core strength, balance and coordination, the PTP CoreBall will help you improve your back muscle imbalances and maintain a healthy posture. Exercising on the CoreBall will stimulate your motor reflexes and force your body to react as an integrated system, providing you with a more beneficial dynamic exercise movement. As your body tries to remain stable on the CoreBall, you will be able to engage.

PTP039



COREBALL 65 CM
GYM BALL

Featuring a 65 cm diameter, the Onyx Black PTP CoreBall is recommended for individuals from 165 cm (5 ft 4) up to 185 cm (almost 6 ft 1). Back pain often stems from poor posture, muscle imbalances and weak core engagement. Add this essential piece of equipment to your home gym to build a strong core, foundation to any functional movements. You can also improve your posture by simply using your CoreBall as an alternative to your office chair.

PTP040



COREBALL 75 CM
GYM BALL

The PTP CoreBall is a versatile pro-grade gym ball that can be used during core stability and flexibility exercises. In particular, using a CoreBall can help activate the muscles surrounding the abdomen, the pelvic floor and the back, which act as the important foundation to all functional movements and daily activity in general. This particular Steel Grey CoreBall is our largest CoreBall and features a 75 cm diameter, which makes it suitable for individuals who are over 185 cm (or almost 6 ft 1) tall. All our CoreBalls come with a bonus pump for added convenience.

PTP041



CORE SLIDERS
DYNAMIC TRAINING DISCS

Add a dynamic dimension to your exercises and take your performance to the next level. The Core Sliders provide an efficient workout by challenging your core stability, cardiovascular endurance, strength and flexibility - all at the same time. Because they let you move forward, backward, side-to-side and rotate - without restrictions, they are also ideal for functional sports training. The hexagonal design accommodates both hands and feet for maximum exercise versatility. The Core Sliders feature two distinctive low-friction surfaces to easily slide on carpet or hardwood floors.

PTP042



REACTION BALL
6 SIDED BOUNCE BALL

Take your sports performance to the next level by improving your reflexes, speed, agility and hand-eye coordination. The multiple protrusions create erratic bounces when the ball hits a surface, forcing you to quickly shift direction to retrieve it. Use it against a wall solo or with a partner for added fun.

PTP043



AGILITY BAND
TANDEM SPEED RESISTANCE TRAINER

Become faster and reach your full potential by improving your running biomechanics with the PTP Agility Band. This functional training tool is perfect to condition your hips, glutes and legs and enhance your sports performance. The further you run, the harder the challenge as the resistance intensifies. The wide webbing sits comfortably around your waist and lets you lean into the required body position (approximately 45 degrees) for optimum acceleration and speed from start to finish.

PTP044



ELITE
SKIPPING ROPE
JUMP ROPE

Engineered with durability and comfort in mind, the Elite Rope is the perfect tool for total body conditioning, improving agility, coordination and endurance. The inner snap system makes it a breeze to adjust to size, while the rotating mount prevents rope tangling.

Includes: 3m Rope

PTP045



HI-SPEED
SKIPPING ROPE
LIGHTWEIGHT SPEED ROPE

Take your cardiovascular workout to the next level with maximum jump speed with the Hi-Speed Rope. By simply twisting the aluminum cap, you can easily customise the length to your own height or fitness level. The handles are designed for effortless grip and efficient wrist rotation.

Includes: 3 m steel cable

PTP046



POWER
SKIPPING ROPE
WEIGHTED ROPE

Challenge yourself like never before for maximum endurance and calorie burning. Recommended for advanced users, the Power Rope features weights for improving shoulder, forearm and wrist strength. The custombuilt anodised aluminum handles provide smooth rotation at every jump. By simply twisting the aluminum cap, you can easily remove the weights and customise the length of the rope to your own height.

Includes: 3 m rope | 2 x 200 g removable weights

PTP047



X ROLLER

DEEP TISSUE MASSAGE ROLL

Ultra-compact and portable, the PTP XRoller is an effective Self-Myofascial Release tool used to stimulate the stretch reflex in muscles, improve joint mobility and relieve nagging pains

in the upper and lower back, adductors, IT Band, hamstrings, calves and quadriceps. A range of exercises carefully designed will bring awareness of your muscle imbalances, therefore contributing to correct your body's alignment and reduce your chance of recurring injury.

PTP048	X Roller Camouflage
--------	---------------------



MYOXV VIBRATING ROLLERS

RECOVERY

The MYOXV & MYOXV2 are ideal for both Pre and Post Training Rolling Routines.

PRE-EXERCISE Prepares the muscles by increasing their elasticity, reducing stiffness, promoting circulation and increasing local temperature which enhances muscle fibre activation.

POST-EXERCISE Enhances blood flow to rehydrate the fascia, reduces pain in the muscles and joints, improves muscle tone and Range Of Movement (ROM) which is vital for rest and recovery.

PTP052	MYOXV
PTP053	MYOXV2



FASCIA ROLLER

FOAM ROLLER + STRETCHING STRAP

Using the SMR (Self-Myofascial Release) technique and your own body weight, the PTP Fascia Roller allows you to self-massage hard to reach sore areas and target multiple muscles such as the calves, lats, glutes, adductors, quadriceps, hamstrings, hip flexors, thoracic spine (trapezius and rhomboids) and tensor fasciae latae muscle (muscle of the thigh). Comes with stretching strap.

PTP049	30cm Fascia Roller
PTP050	45cm Fascia Roller
PTP051	80cm Fascia Roller



THERAPY ROLLER

MULTI-TARGETED MASSAGE ROLLER

Providing stimulating sensations, the PTP Massage Therapy Roller is designed to release muscle tension and restore joint mobility. The pyramidal projections offer a multi-targeted approach, while the robust hollow core guarantees a deep tissue massage that penetrates through the layers of muscle and fascia. The Large Massage Therapy Roller offers the same level of compression and trigger pointing but, at 60 cm, it provides greater stability during back massages and enables an efficient massage of both calves, hamstrings, or upper arms, simultaneously. The recessed mid-section is designed to offer an additional, alleviated level of pressure.

PTP054	60cm Therapy Roller
PTP055	30cm Soft Therapy Roller
PTP056	30cm Firm Therapy Roller

Please visit www.slatertrellsports.com.au for up to date pricing.

FLEXIBAND
ELASTICATED WOVEN
STRETCHING LOOP

The special elasticated woven construction of the PTP FlexiBand provides leverage and resistance at the same time. This means you can perform deeper stretches and hold them for longer without the risk of extending beyond the natural range of motion of your joints. Highly versatile, the FlexiBand can be used before and after a workout to increase flexibility and range of motion in both your upper and lower body. It is also a great tool to prevent work or sports-related injuries.



FLEXIBAND SMALL
ELASTICATED WOVEN
STRETCHING LOOP

PTP057



FLEXIBAND MEDIUM
ELASTICATED WOVEN
STRETCHING LOOP

PTP058



FLEXIBAND LARGE
ELASTICATED WOVEN
STRETCHING LOOP

PTP059



MYOSTICK
MYOFASCIAL RELEASE STICK

Recover faster with the PTP Myostick by self-massaging sore areas in your calves, ITBs, glutes, adductors, quadriceps, hamstrings or TFLs. It allows you to easily perform myofascial release and optimise the full width and length of your muscles. Use it before and after any physical activity to activate blood circulation and ultimately improve flexibility and sports performance.

PTP060



MYOSPHERE
DEEP TISSUE MASSAGE BALL

The PTP MyoSphere has been specifically designed for use on the large troublesome muscles in the legs (calf and hamstring), hips, gluteals, torso (pecs and obliques), shoulders and upper back. Providing a firm massage of the soft tissues, the MyoSphere textured surface provides superior traction, which will help you perform effective self-myofascial release, improve flexibility, activate blood circulation and reduce downtime.

PTP061



MYO-X2
BILATERAL DEEP TISSUE MASSAGER

Offering a convenient deep tissue massage, the PTP Myo-X2 is specifically designed for use on the back. The recessed mid-section accommodates the spinal joints, making it ideal to roll out the muscles along both sides of the vertebral column (bilateral symmetry). The ergonomic morphology can also prove useful to simultaneously target the right and left sides of muscles, such as biceps, triceps, hamstrings, quadriceps and calves.

PTP062



TRACKBALL
SPINE-CRADLING MASSAGE TOOL

The PTP Track Ball is a convenient self-massaging tool that can be used to help you alleviate muscle tension, improve the range of motion of your spinal joints and reduce your chance of recurring back and neck pain. Ergonomically designed to contour the anatomy of the spine, it helps to access muscles and fascia and minimise the impact on skeletal alignment.

PTP063

Firm

PTP064

Soft



TRIFLEX SET
ACUPRESSURE TOOLS - SOFT & FIRM

With our compact PTP Triflex set, easily access your knots/trigger points and get self-pain relief when and wherever you need it the most. The unique design that mimics the bent finger action used in therapeutic massages lets you apply targeted pressure to the source of pain. You can adjust the level of pressure to your own pain threshold by simply switching tools.

PTP065

Combo



MASSAGE BALLS
DEEP TISSUE BALLS - SOFT & FIRM

The PTP Massage Balls have been designed to provide two distinctive levels of tissue massage. You can use one and/or the other to relieve varying muscle tension that affects your feet, glutes, hips, back, shoulders, forearms and more. Through direct pressure and deep muscle penetration, the Massage Balls help release trigger points and break up soft tissue minimise the impact on skeletal alignment.

PTP066

Combo



TRIGGER BALLS
ACUPRESSURE BALLS

The PTP Trigger Balls allow you to easily target specific over-stressed body areas by pressing, pulling or twisting soft tissue restrictions. Use your own body weight for an intense massage or your hand for more pressure control. The two distinct densities will help you suit various body areas and matching pain thresholds.

PTP067 Combo



SENSORY BALL
ACUPRESSURE MASSAGE BALL

The PTP Sensory Ball is designed to activate blood flow and relieve pain in your back, neck, shoulders and the arches of your feet. Using your own body weight, you can apply varied pressure and suit your own relaxation needs. The small sensory points aim to stimulate the nerve endings to relax your nervous system.

PTP068



ICE BALL
COLD THERAPY BALL

The Ice Ball is designed to provide long-lasting cooling without melting. Use it frozen for instant acute pain relief and swelling reduction. Or use it unfrozen for a frictionless massage that activates blood circulation and boosts recovery. The unique finger groove design of the protective cover allows for a comfortable grip and prevents fingers from getting cold. The removable steel ball can be used on its own to easily self-massage those hard-to-reach problem areas.

PTP069



THERAPY TWISTER
HAND & FOREARM STRENGTHENING BAR

Helps strengthen grip, upper extremity function and joint mobilisation. Used to perform exercises involving gripping, twisting, bending and oscillating. Suitable for neuromuscular training and rehabilitation post-injury or surgery.

PTP070



STRENGTH GRIP
HAND & FOREARM STRENGTHENING TOOL

Designed to strengthen the fingers, wrist and forearm muscles, the PTP Strength Grip is perfect for those who wish to enhance their sports performance and prevent hand injuries. Fostering tendon gliding, finger range of motion and dexterity, it is also suitable for rehabilitation.

PTP071



HAND GRIPS
FINGER & WRIST EXERCISERS - SOFT & FIRM

Improve hand opening/closing strength, tendon gliding, motor coordination and stabilisation. The soft Hand Grip is designed for post-trauma rehabilitation, while the firm one is intended for sports performance optimisation and injury prevention.

PTP072



HYPER COOL
INSTANT COOLING MESH TOWEL

Stay fresh and beat the heat with the Hyper Cool Towel. The high performance mesh allows for effective moisture evaporation and airflow through the fibres, resulting in long-lasting cooling.

PTP073 Black
PTP074 Grey
PTP075 Blue



PTP™
TOWEL X
GYM TOWEL WITH BENCH SLEEVE,
MAGNET & ZIP POCKET

Train in comfort and stay dry during those intense sessions. Made from 100% superior terry cotton with long loop weaves, the TowelX is extremely soft and absorbent. Keep your towel readily accessible and away from germs thanks to the powerful concealed magnet allowing you to effortlessly secure your towel directly onto any exercise machine or locker.

PTP076 Black & Charcoal
PTP077 Teal & Charcoal



**BODYWORX 7493KBR
KETTLEBELL RACK**

- Simple design solid construction.
- Flat tray for easy storage & easy grab.
- Rubber plate protects both rack & kettlebells.
- High quality metallic powder coating.
- Assembled Dimension:
122cm (L) x 51cm (W) x 69cm (H).

Note: Kettlebells Not Included

3048



**WEIGHTS
DUMBBELL
HEX RUBBER EACH**

3070	1kg
3071	2kg
3072	3kg
3073	4kg
3074	5kg
HEX8	6kg
3075	7kg
HEX10	8kg
HEX11	9kg
3076	10kg
3077	12.5kg
3078	15kg
HEX1	17.5kg
3079	20kg
HEX2	25kg
HEX3	30kg
HEX4	35kg
HEX5	40kg
HEX6	45kg
HEX7	50kg



**KETTLEBELLS
DUAL COLOUR**

100026	2kg	Each
100027	4kg	Each
100028	6kg	Each
100029	8kg	Each
100030	10kg	Each
100031	12kg	Each
100032	16kg	Each
100033	20kg	Each



**WEIGHTS
DUMBBELL
PVC COATED EACH**

3080	0.5kg
3081	1kg
3082	1.5kg
3083	2kg
3084	2.5kg
3085	3kg
3086	4kg
3087	5kg



**LOUMET
GYM BALLS**

Extremely durable and hard wearing Evenly weighted to bounce and float.

9118	1kg
9119	2kg
9120	3kg
9121	4kg
9122	5kg
9123	6kg



**RUBBER
DOUBLE GRIP
GYM BALLS**

9115	3kg
9116	5kg
9117	7kg



**RUBBER GYM BALLS TWO
TONE**

9107	1kg
9108	2kg
9109	3kg
9110	4kg
9111	5kg
9112	6kg
9113	7kg
9114	8kg
3118	9kg
3119	10kg



GYM BALL DISPLAY STAND

- Holds 5 Medicine balls
 - Metallic grey powder coated
 - Modern design and finish
 - Can be used to display balls in a store or as a convenient storage option in a gym or at home
- Note: Gym Balls in the image are not included.

100064



RINGMASTER MEDICINE BALL AND KETTLE BELL STAND

- Holds 4 Medicine balls and 5 Kettlebells
- Dark grey powder coated
- Convenient way to store Kettlebells without taking up too much floor space
- Great for display in a retail shop or for storage at home.

30063



TRIANGLE WEIGHT PLATE RACK

- Heavy duty steel construction
- Triangle shape with 5 prongs to store plates

30064



WEIGHT PLATES RINGMASTER

28MM REGULAR HOLE

3100	0.5kg
3101	1.25kg
13102	2.5kg
3103	5kg
3104	7.5kg
3105	10kg
3106	15kg
13153	20kg
13149	25kg



OLYMPIC WEIGHT EZ GRIP PLATE

52MM CENTRE DIAMETER

3110	1.25kg
3111	2.50kg
3112	5kg
3114	10kg
3115	15kg
3116	20kg
3117	25kg



OLYMPIC RUBBER PLATES

52MM CENTRE DIAMETER

3120	2.5kg
3121	5kg
3122	10kg
3123	15kg
3124	20kg
3125	25kg



INFLATABLE TONING BALLS RINGMASTER

3150	55cm
3151	65cm
3152	75cm
3149	Swiss Ball Training DVD

INFLATABLE TONING BALL SIZING GUIDE

USER HEIGHT	BALL SIZE
Up to 170cm	55cm
170 - 185cm	65cm
Above 185cm	75cm



LOUMET PRO FITNESS TONING BALLS

The Loumet Fitness Ball Pro is the premium fitness ball.

Manufactured using Loumet 'Metflex' compound it has been officially weight tested by Adelaide University to hold 350kg (770lbs) without bursting. Unofficial weight testing has shown the Pro ball to have a static weight loading in excess of 1100kg (2400lbs).

3154	45cm Pro Fitness
3155	55cm Pro Fitness
3156	65cm Pro Fitness
3157	75cm Pro Fitness
3158	85cm Pro Fitness



BARBELL / DUMBBELL

3130	A. Barbell 72" With Collars	Each
3131	Barbell 66" With Collars	Each
3132	B. Barbell 60" With Collars	Each
3133	C. Curl bar 47"	Each
3134	D. Dumbbell 14" With Collars	Pair



**BODY BAND ROLLS
25M X 100MM**

3160	Light - Red
3161	Medium - Green
3162	Strong - Blue
3163	Strong - Black

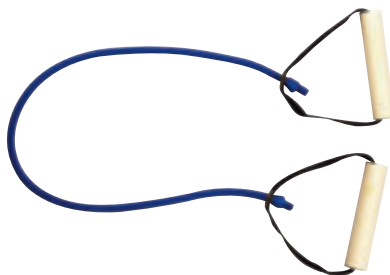

BODY TUBE

3170	Light - Yellow
3171	Medium - Green
3172	Strong - Red
3173	Extra Strong - Blue



**SWISS BALL
SUPER PUMP**

New double action, heavy duty stirrup pump, features large handle & foot plate.

37795



**WEIGHT DUMBBELL
BARBELL SET**

314050	50kg Set
314020	20kg Set



COLOURED HAND GRIPS

Strengthen and tone your hands and forearms with these Ringmaster Strong Hand Grips. They are designed for arm and hand muscle development, adding tone and definition to existing muscles while building up overall strength. Available in the following colours: Orange, Green or Purple.

3141O	Orange	Each
3140G	Green	Each
3140P	Pink	Each



**GYMBOSS
CLASSIC TIMER**

The Classic Gymboss timer is perfect for anyone looking for a dedicated interval timer for daily workouts. 1 or 2 intervals - 2 seconds to 99 minutes. Repeat up to 99 times. Beep and/or Vibrate alarm. Alarm duration 1, 2, 5, or 9 seconds. Stopwatch function. Clock function. Secure removable Belt clip. Compact Size (1 3/4 x 2 1/4 x 1/2 inches). Water and shock resistant. AAA battery required.

5936 Gymboss Classic Timer



SKIPPING ROPES PVC

3203	1.8m (6FT) - Orange Handles
3204	2.1m (7FT) - White Handles
3205	2.4m (8FT) - Green Handles
3206	2.7m (9FT) - Red Handles
3207	3.0m (10FT) - Blue Handles
3208	4.5m (15FT) Yellow Handles
3209	9m (30FT) Purple Handles



SKIPPING ROPES COLOURED

9 Foot Coloured PVC Skipping Ropes.

3200G	2.7m (9FT) Green	Each
3200P	2.7m (9FT) Pink	Each
3200O	2.7m (9FT) Orange	Each



SKIPPING ROPE LEATHER

3202	Weighted Handle Leather
------	-------------------------



BATTLE ROPE DELUXE 15M

Battle rope 15 metre deluxe with wall mount and carry bag.

BR001



BATTLE ROPE DELUXE 9M

Battle rope 9 metre deluxe with wall mount and carry bag.

BR002



BATTLE ROPE STANDARD 15M

Battle rope 15 metre standard.

BR003



3 STAGE AEROBIC STEP

- Step features an anti-slip surface
- Adjustable from 10cm-20cm in 3 easy stages
- Great for a total body workout
- Wide range of benefits including increased lung capacity and improved co-ordination
- Max Loading Weight: 200kg
- Size: 78cm x 30cm x 10-20cm

30141 3 Stage Aerobic Step



RINGMASTER LEATHER SKIPPING ROPE 9' (2.75M)

- Step features an anti-slip surface
- Adjustable from 10cm-20cm in 3 easy stages
- Great for a total body workout
- Wide range of benefits including increased lung capacity and improved co-ordination
- Max Loading Weight: 200kg
- Size: 78cm x 30cm x 10-20cm

3201



FLOOR MATS BLACK

3220 4 Squares 500mm x 500mm



FLOOR MATS WOOD

3221 4 squares 500mm x 500mm



FLOOR TO CEILING

- 325210 Professional 10"
- 325212 Professional 12"
- 3253 Fitness 10"
- 3254 Strands per pair
- 3255 Bladder



SPEEDBALLS

- 3230 10" leather Jim Bradley
- 3231 16" leather Jim Bradley
- 323310 Speedball Deluxe 10"
- 323312 Speedball Deluxe 12"
- 323313 Speedball Fitness
- 3234 Speedball Platform International
- 3235 Swivel
- 3236 Bladder



HOOK & SWIVEL

- 3241 Hook & Swivel Deluxe
- 3242 Speedball Swivel Nylon



YORK FITNESS PEDOMETER

- Counts steps taken up to 99,999
- Measures theoretical calorie burn based on your personal input
- Calculates distance traveled and travelling speed
- Features count down/up timer
- Complete with convenient belt clip
- Measures: Steps, Distance, Calories, Speed, Time

3225



PRO TRAINING KIT

Includes: 5 x Pair of Training Mitts, 5 x Pair of Curved Focus Pads & 1 x Bag.

3260



CLUB TRAINING KIT

Includes: 5 x Pair of Club Mitts, 5 x Pair of Curved Focus Pads & 1 x Bag.

3261



PRO WORKOUT KIT

- Suitable for: Professional Fitness Training
- 1 x pair of Pro Fitness Mitts – size: Large
- Champs choice premium leather and synthetic leather outer cover.
- 1 x pair of Pro Curved Focus Pads
- Champs choice premium leather and synthetic leather outer cover
- Uniquely curved design to help both the speed of punches and for the holder's protection
- Finger cover providing maximum protection and mesh to provide ventilation
- Colours Available: Blue/White

30067



BOXING TRAINER

- Fill with sand or water

3265



HEAVY DUTY BOXING TRAINER

- Fill with sand or water

3266



FOCUS PADS

- 3270 A. KO Deluxe
- 3271 Fitness PVC Curved
- 3272 Professional Kick
- 3273 B. Leather International
- 3274 C. Leather Deluxe Curved
- 30068 D. Pro Focus Pad Straight



BOXING GLOVES

- 3280 8oz Fitness
- 3281 10oz Fitness
- 3282 12oz Fitness
- 3283 14oz Fitness
- 3284 16oz Fitness
- 328510 10oz Professional
- 328511 11oz Professional
- 328512 12oz Professional
- 328513 13oz Professional
- 328514 14oz Professional
- 328515 15oz Professional
- 328516 16oz Professional
- 328610 10oz International
- 328611 11oz International
- 328612 12oz International
- 328613 13oz International
- 328614 14oz International
- 328615 15oz International
- 328616 16oz International



WEIGHT GLOVES PRO

- 3300S Small - Pro Gloves
- 3300M Medium - Pro Gloves
- 3300L Large - Pro Gloves
- 3300XL XL - Pro Gloves



WEIGHT GLOVES FITNESS

- 3301S Small - Fitness Gloves
- 3301M Medium - Fitness Gloves
- 3301L Large - Fitness Gloves
- 3301XL XL - Fitness Gloves



TRAINING FITNESS MITTS

- 3310M Medium - Pro Leather
- 3310L Large - Pro Leather
- 3310XL XL - Pro Leather
- 3311M Medium - Leather/Synthetic
- 3311L Large - Leather/Synthetic
- 3311XL XL - Leather/Synthetic
- 3312S Small - SG Leather/Synthetic
- 3312M Medium - SG Leather/ Synthetic
- 3312L Large - SG Leather/ Synthetic
- 3312XL XL - SG Leather/ Synthetic

TRAINING BAG MITTS

- 30069 Medium - Red/Grey - Heavy Bag
- 30070 Large - Red/Grey - Heavy Bag
- 30071 XL - Red/Grey - Heavy Bag
- 30072 Medium - Blue/White - Fitness
- 30073 Large - Blue/White - Fitness
- 30074 XL - Blue/White - Fitness
- 30075 Small - Black/Green - Bag
- 30076 Medium - Black/Green - Bag
- 30077 Large - Black/Green - Bag
- 30078 XL - Black/Green - Bag



HAND WRAPS

3328	Fitness
3329	International



HEAD GEAR FOR BOXING

3326	Head and Cheek Professional
3327S	Senior - Fitness
3327J	Junior - Fitness



WEIGHT BELTS

3320M	A. Medium 44" - Pro
3320L	A. Large 44" - Pro
3320XL	A. XL 44" - Pro
3321S	Small - Club
3321M	Medium - Club
3321L	Large - Club
3321XL	XL - Club



PUNCHING & KICK BAGS

3330	SG 6000 Bag 1830mm
3331	SG 5000 Bag 1525mm
3332	SG 4000 Bag 1220mm
3333	SG 3000 Bag 915mm



PUNCHING BAG STAND

3350	
------	--



SG PUNCHING BAG WALL BRACKET

3358	
------	--



HOOK & SWIVEL

3241	Hook & Swivel Deluxe
3242	Speedball Swivel Nylon

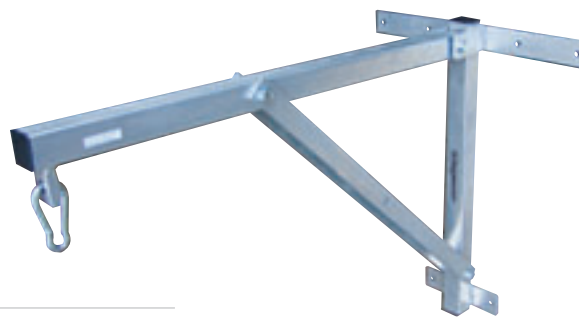

PUNCHING BAG WALL BRACKET

3355	
------	--



TWO TIER DUMBBELL RACK

3370



WEIGHT PLATE RACK OLYMPIC

3371



WEIGHT PLATE RACK STANDARD

3372



WEIGHT BENCH

3381 Max Capacity: 150kg



BASIC BENCH WITH ADJUSTABLE POSTS & LEG DEVELOPER

30084



TREADMILL SILICONE SPRAY

Correct and ONLY product to use if you wish to maintain your treadmill properly.

3389



MINI TRAMPOLINE 38"

3380



CHIN UP TOWER

- Chin up section has multiple grip positions for a range of exercises
- Leg raise section
- Dips section
- Push up/sit up ground exercise section
- Pack size – 1 carton: 140 x 41 x 22cm – weight 37kg
- Assembled size: 136cm (L) x 108cm (W) x 217cm (H)

30082

FITNESS CIRCUIT STAND

- Made from heavy duty rectangular steel tubing
The stand comprises of the following:
- Power tower:
 - Chin up section– with multiple grip positions
 - Leg raise section
- Dips section
 - Push up/sit up ground exercise section
- Punch bag section:
 - Can hold 1 x Punch bag up to 122cm (4000)
- Speedball section:
 - Adjustable height speedball platform (**SPEED-BALL NOT INCLUDED**)
- Floor to Ceiling ball section:
 - Top and base tie down loops for easy attachment
 - Pack size 2 cartons: CARTON 1: (35KG) 177.5 x 65.5 x 16.5cm and CARTON 2: (26KG) 143 x 42 x 13cm
 - Assembled size: 170cm (L) x 187cm (W) x 216cm (H)

30213





**BODYWORX ADPE DUO
PURPOSE MAG BIKE**

Key Features:

- 1x Large LCD display.
- Time.
- Speed.
- Distance.
- Calories.
- Manual Tension Dial.
- Can be used by Foot or Hand.

ADPE



**BODYWORX ABX350M
UPRIGHT BIKE**

Key Features

- Resistance: 8 Level Resistance.
- Console Display: LCD display which shows Time, Speed, Distance, Calories & Pulse.
- Heart Rate: Contact.
- Seat Adjustment: Quick release Pop-pin with Up/Down as well as Forwar/Back adjustment.
- Cranks: 3 Piece Crank.
- Pedals: Wide Pedals with adjustable Straps.
- Saddle: Large comfort Saddle.
- Flywheel: 6KG.
- Assembled Dimensions: 98cm (L) x 53cm (W) x 144cm (H).
- Weight Capacities:
Maximum User Weight: 130KG (287LBS).

Other Features:

- Water Bottle Holder.
- Transportation Wheels.
- Adjustable rear stabiliser for maximum stability on uneven surfaces.

ABX350M



**BODYWORX A117BB SPIN
BIKES**

Key Features

- Tension Control: Dial knob with push down Emergency Brake.
- Saddle: Extra padding.
- Seat Slider: Forward / Backward.
- Seat Post: Up / Down.
- Handlebar: PVC dipped Handlebar.
- Handlebar / Seat Posts: Quick Release Pop-pin knob.
- Transportation Wheels: Yes.
- Flywheel: 14 KG.
- Pedals: Metal with toe clip & adjustable strap.
- Bottom Bracket: Sealed bottom bracket.
- Crank: 3 piece Crank.
- Transmission: Belt Drive.
- Bottle Cage: Steel with plastic Water Bottle.
- Emergency Brake: Yes.
- Weight Capacities:
Maximum User Weight: 115 KG (253 LBS).

Optional TASB800COM Computer:

- Functions: Time, Speed, Distance, Estimated Calories & Scan Mode.
- Frame: Pre-assembled with Bracket & Sensor for Computer.

A117BB



**BODYWORX AB170M
MANUAL MAG
UPRIGHT BIKE**

Key Features:

- Resistance: 8 Level Manual Tension.
- Console Display: LCD Display which shows Scan / Speed / Time / Distance / Calories / Pulse.
- Seat Adjustment: Quick Release Pop-pin with Up / Down as well as Forward / Back Adjustment.
- Handlebars: Adjustable.
- Cranks: 3 piece Crank.
- Pedals: Two-tone big Pedals.
- Saddle: Large two-tone deluxe comfort Saddle.
- Flywheel: 5 KG.
- Assembled Dimensions:
90cm (L) x 47cm (W) x 125cm (H).
- Weight Capacities:
Maximum User Weight: 10 KG (242 LBS).

Other Features:

- Water Bottle Holder.
- Adjustable Handlebars.

AB170M



**BODYWORX ABX450AT
PROGRAMMABLE MAG
BIKE**

Key Features

- Resistance: 24 Levels Auto Tension.
- Console: Backlit LCD display which show Time, Distance, RPM, Speed, Calories, Watt, Pulse & Recovery.
- Programs: 12x Pre-set, 4x User, 5x HRC (55%, 65%, 75%, 85%), 1x Bodyfat, 1x Target & 1x Manual.
- Seat Adjustment: Forward / Back adjustment.
- Heart Rate: Contact + Built-in Receiver.
- Cranks: 3 piece Crank.
- Pedals: Two-tone big Pedals.
- Saddle: Large two-tone deluxe comfort Saddle.
- Flywheel: 8KG.
- Assembled Dimensions:
102cm (L) x 51cm (W) x 140cm (H).
- Weight Capacities:
Maximum User Weight: 150 KG (242 LBS).

Other Features:

- Water Bottle Holder.
- Adjustable Handlebars.
- Transportation Wheels.
- iPad/Tablet Holder.

ABX450AT



BODYCRAFT ASPX SPX INDOOR CYCLE

Key Features

- Frame: Heavy-duty steel frame with two layers of powder coat paint to prevent rust.
 - Flywheel: 21 KG (46LBS), precision flywheel is perimeter weighted for high inertia & spins on german-made SKF™ sealed bearings.
 - Drive: French made Hutchinson™ SPK V-ribbed automatic belt.
 - Resistance: Patented friction brake with micro-adjust safety knob & emergency stop.
 - Lower Bracket: Heat treated cro-moly axle turns on sealed German made SKF™ bearings.
 - Cranks: Three piece cold forged Steel 175mm long.
 - Pedals: Aluminium alloy pedals with toe straps. Can be switched to SPD's.
 - Seat Post / Handlebar Stem: Stainless steel with engrave scale, hexagonal shape creates a very rigid connection & micro-adjustments to fit all sizes & styles.
 - Seat: Top quality Velo™ saddle.
 - Optional: Computer Console (TAVORTEC).
 - Assembled Dimensions: 61cm (24") W x 110cm (43") L x 120cm (47") H.
 - Weight Capacities: Maximum User Weight: 136 KG (300LBS).
- Other Features:
- Two water bottle holders included.

ASPX



BODYWORX ARX700 RECUMBENT BIKE

Key Features

- Resistance: 32 Levels Auto Tension.
- Console: Backlit LCD display which show Scan, Time, Speed, Distance, Calories, RPM & Pulse.
- Programs: HRC, Beginner, Advance, Sporty, Cardio, Watt Program, R recovery, Bodyfat & Manual.
- Heart Rate: Contact & Polar™ Receiver.
- Seat Adjustment: Forward/Back adjustment.
- Handlebars: Adjustable.
- Cranks: 3 Piece Crank.
- Pedals: Two-tone big Pedals.
- Saddle: Large moulded Saddle.
- Back Rest: Mesh for ultra comfort.
- Flywheel: 9KG.
- Assembled Dimensions: 154.5cm (L) x 32.5cm (W) x 70.5cm (H).

Weight Capacities:

- Maximum User Weight: 150KG (331LBS) .

Other Features:

- Smart Phone & Tablet Holder.
- USB Charger.
- Bluetooth with APP.
- Transportation Wheels.

ARX700



BODYWORX A932 DELUXE SERIES PROGRAMMABLE RECUMBENT BIKE

Key Features

- Resistance: 32 Level Computer Controlled Resistance.
 - Console: Dual coloured backlit display with illuminated LED buttons.
 - Programs: 12x Pre-set, 4x HRC, Recovery, Watts (Constant Power) + Manual.
 - Heart Rate Recovery: Comes complete with Built-in Receiver & Chest Strap for accurate Heart Rate Monitoring & Control + Contact.
 - Seat: Riding position for all users & adjustable backrest.
 - Handlebar: Fixed.
 - Crank: 3 piece Crank System provides strength & reliability.
 - Pedals: Self balancing Pedals with adjustable Foot Straps.
 - Assembled Dimensions: 168cm (L) x 70cm (W) x 114cm (H).
- Weight Capacities:
- Maximum User Weight: 130 KG (286 LBS).

A932



**BODYWORX EFX580
PROGRAMMABLE
ELLIPTICAL**

Key Features

- Resistance: 16 levels Motorised System.
- Console: Single extra large blue backlit LCD display that shows Speed, Distance, Calories, RPM, Count, WATT & Pulse.
- Programs: 7 pre-set programs, body fat programs, target heart rate programs, 3 heart rate control programs & Time.
- Stride Length: 17 Inches.
- Cranks: Disc Crank.
- Flywheel: 7KG.
- Assembled Dimensions: 174cm (L) x 69cm (W) x 164cm (H).

Weight Capacities:

- Maximum User Weight: 120KG (265LBS).

Other Features:

- Smart Phone & Tablet holder.
- Built-in-Receiver.

EFX580



**BODYWORX
COLORADO 150
TREADMILL**

Key Features

- Motor: 1.5 HP.
- Speed: 0.8-16 K/PH.
- Console Display: 5" LCD Screen.
- Programs: 12x Pre-set + 3 User + Body Fat.
- Running Area: 42cm x 130cm (16.5" x 51") Standard 1.4mm (Diamond finish).
- Deck Thickness: 15mm.
- Incline: 12 levels.
- Heart Rate: Contact.
- Hand Rail Buttons: Speed + Incline.
- Instant / Quick Keys: Speed + Incline.
- Front Rollers: 46mm.
- Rear Rollers: 42mm.
- Assembled Dimensions: 171cm (L) x 71cm (W) x 139cm (H).
- Weight Capacities: Maximum User Weight: 110 KG (242 LBS).

Other Features:

- MP3 Jack & Speaker.
- Bluetooth Music.

JCOLORADO150



**BODYWORX
COLORADO 200
TREADMILL**

Key Features

- Motor: 2.0 HP.
- Speed: 0.8-18 K/PH.
- Console Display: 7" LCD Screen.
- Programs: 15x Pre-set + 3 User + Body Fat.
- Running Area: 48cm x 140cm (18" x 55") Standard 1.6mm (Diamond finish).
- Deck Thickness: 15mm.
- Incline: 15 levels.
- Heart Rate: Contact.
- Hand Rail Buttons: Speed + Incline.
- Instant / Quick Keys: Speed + Incline.
- Front Rollers: 50mm.
- Rear Rollers: 46mm.
- Assembled Dimensions: 182cm (L) x 75cm (W) x 145cm (H).

Weight Capacities:

- Maximum User Weight: 130 KG (286 LBS).

Other Features:

- MP3 Jack & Speaker.
- Bluetooth Music.

JCOLORADO200



**BODYWORX
L800LPHS LEG PRESS
/ HACK SQUAT**

Key Features

- Designed for leg press, hack squat & calf raise.
- Heavy duty construction for exceptional stability.
- Frictionless 8x needle bearing wheels to position the carriage to ensure smooth movement & distribute weight evenly.
- Both back pads utilise a flip-and-lock mechanism, allowing easy conversion from leg press to hack squat & calf raise.
- Heavy gauge diamond plate foot platform is adjustable to multiple angles.
- Back pads contoured for lumbar support.
- High quality metallic powder coating.
- Assembled Dimension: 201cm (L) x 93cm (W) x 143cm (H).

Weight Capacities:

- Maximum Weight Capacity: 400 KG (882 LBS).

L800LPHS



BODYWORX COLORADO 300 TREADMILL

Key Features

- Motor: 3.0 HP.
- Speed: 0.8-22 K/PH.
- Console Display: 6 window coloured LED screens + 2x coloured Dot Matrix screens.
- Programs: 15x Pre-set + 3 HRC + 3 User + Body Fat.
- Running Area: 52cm x 152cm (20.5" x 60") Standard 2.5mm (Ortho).
- Deck Thickness: 18mm.
- Incline: 15 levels.
- Heart Rate: Contact.
- Built in Receiver: Yes Polar™.
- Hand Rail Buttons: Speed + Incline.
- Instant / Quick Keys: Speed + Incline.
- Front Rollers: 60mm.
- Rear Rollers: 50mm.
- Assembled Dimensions: 192cm (L) x 85.5cm (W) x 151cm (H).
- Weight Capacities: Maximum User Weight: 150 KG (331 LBS).

Other Features:

- MP3 Jack & Speaker.
- Bluetooth Music.
- USB for Music.

JCOLORADO300



BODYWORX JT8500 LIGHT COMMERCIAL TREADMILL

Key Features

- Motor: 2.0 HP AC.
- Speed: 0.8-22 K/PH.
- Console Display: 6 Window Red LED Screens + 1 large Red Dot Matrix Screen.
- Programs: 16x Pre-set with 15 levels + 3 User + Bodyfat + 3 HRC.
- APPS: iConsole+, FitHiWay & Kinomap.
- Running Area: 56cm x 154cm (22" x 61") 2.5mm Orthopaedic mat.
- Side Rail: Extruded Aluminium with non-slip foot pads.
- Incline: 15 Levels.
- Heart Rate: Contact.
- Built in Receiver: Yes Polar™.
- Instant/Quick Keys: Speed + Incline.
- Rollers: 67mm.
- Maximum User Weight: 180KG (397LBS).
- Assembled Dimensions: 208cm (L) x 85cm (W) x 152cm (H).

Other Features:

- MP3 Jack & Speakers.
- USB Port for charging.
- Built-in Bluetooth connectivity for APPS.

JT8500



BODYWORX JT9500 COMMERCIAL TREADMILL

Key Features

- Motor: Commercial Grade 4 HP AC Motor.
- Speed: 0.8-25 K/PH.
- Console: LED Dot-Matrix display which shows Time / Speed Incline / Distance / Pulse & Calories.
- Programs: 6x Pre-Set with 10 Levels + 1 HRC + 2x Custom & 1x Manual.
- Running Area: 157.5cm (L) x 56cm (W), (62" x 22").
- Running Mat: 3mm Commercial Orthopedic mat.
- Side Rail: Full Aluminium.
- Incline: 15% (16 Levels).
- Heart Rate: Built-in receiver + contact.
- Hand Rail Buttons: Speed + Incline.
- Instant / Quick Keys: Speed + Incline.
- Rollers: 76mm.
- Max. User Weight: 180KG (397LBS).
- Assembled Dimensions: 226cm (L) x 92cm (W) x 153cm (H).

Other Features:

- Water bottle holder.
- Cooling Fan.
- Ipad / Tablet Rack.
- Made in Taiwan.

JT9500



BODYWORX C430UB HEAVY DUTY FID UTILITY BENCH

Key Features

- Flat, incline, decline & military pressing positions.
- Easy adjustment of backrest & seat.
- Will accept leg developer / preacher pad, attachments C430AS.
- Adjustable leg holder, oversized foam rollers.
- Adopt to most squat racks, cages & smith machines.
- Heavy duty steel tube construction, high quality metallic powder coating, high density durable upholstery.
- Leg developer & preacher curl.
- Assembled Dimension: 152cm (L) x 65cm (W) x 133cm (H).

Weight Capacities:

- Maximum Capacity: 280 KG (617 LBS) including user weight.

Optional:

- C430AS preacher pad & leg attachment.

C430UB

CUSTOM TEAMWEAR

**YOUR TEAM OR CLUB CAN NOW
LOOK LIKE TRUE PROFESSIONALS.**

Slater-Gartrell Sports clothing range offers a combination of high performance fabrics in conjunction with a comfortable and functional fit to meet a player's match and training kit requirements at every level.

Slater-Gartrell Sports understands the needs of teams and our range of high performance stock match shirts, training wear and leisure garments combined with an extensive range of customised options cater for every scenario.

Our specialised design team can assist and advise on every aspect of incorporating your specific school, club or university colours onto any garment.

Our embroidery and printing facilities allow quick turnaround on stock items which can all be embellished with your club logo, numbers and or sponsor logo.



**SLATER-GARTRELL
SPORTS**

BODYWORX L680T DELUXE LINEAR SMITH COMBO WITH BENCH & STAND



Key Features

- Heavier construction with 7cm x 7cm - 2.0mm thick & 5cm x 7cm - 2.0mm thick high tensile steel tubes on the frame.
- The front main lifting bar hooks onto the 5 cm thick gun rack plates instead of hooking onto the tube.
- The 2 guide rods for the linear bearings are made of super hardened chrome, highly smooth special solid steel rods which are specially used for linear bearings to provide very smooth movement.
- The lat / low row / butterfly attachment is also improved to be heavier & stronger.
- Full Smith system including high lat / low row, pec deck, heavy duty utility bench C430UB & leg developer, preacher curl pad & attachment holder C430AS.
- Extra heavy duty steel tubing construction.
- Linear bearing Smith system provides smooth movement & feeling of commercial style product.
- Chrome sleeve can be removed to accommodate standard size plates.
- Solid guide rods with hardened chrome.
- Uprights features a 7 degree pitch to accommodate the body's natural path of movement.
- High quality metallic powder coating.
- Dimensions:
- Solid Lifting Bar: 199cm (L) x 30mm (Dia).
- Assembled Dimensions: 210cm (L) x 199cm (W) x 214cm (H).
- Weight Capacities:
- Capacity on Bar: 362 KG (800 LBS).
- Weight Plate Carriage: 136 KG (300 LBS).
- Maximum Front Rack Capacity: 365 KG (803 LBS).
- Maximum Bar Capacity: 275 KG (605 LBS).
- Maximum Pec Dec Capacity: 180 KG (396 LBS).
- Maximum High Lat / Low Row Capacity: 180 KG (396 LBS).
- Optional:
- LWS210 optional 95 KG (210 LBS) weight stack.
- C430AS optional accessory stand.

L680T

BODYWORX L680C DELUXE LINEAR BEARING SMITH MACHINE

Key Features

- Olympic plates only.
- Heavy duty construction with 7cm x 7cm - 2.0mm thick & 5cm x 7cm - 2.0mm thick high tensile steel tubes on the frame.
- The front main lifting bar hooks onto the 5cm thick gun rack plates instead of hooking onto the tube.
- The 2 guide rods for the linear bearings are made of super hardened chrome, highly smooth special solid steel rods which are specially used for linear bearings to provide very smooth movement.
- Extra heavy duty steel tube construction.
- Linear bearing smith system provides smooth movement & feeling of commercial style product.
- Solid lifting bar same as a standard 7ft olympic bar.
- Chrome sleeve accommodates olympic size plates.
- High quality metallic powder coating.
- Assembled Dimension: 158cm (L) x 199cm (W) x 209cm (H).

Weight Capacities:

- Maximum Front Capacity: 300 KG (661 LBS).
- Maximum Bar Capacity: 362 KG (798 LBS).

L680C





AGILITY POLES

3452	A. Patrick Agility Poles Standard - 2pce with Screw Spike
3453	B. Patrick Agility Poles Deluxe - Rubber Base 1pce
3455	Patrick Deluxe Agility Pole Set of 4 with Bag - 2pce with Springs
DAP02	Diamond 2 Piece Agility Pole 1.7m Set of 12
DAP03	Diamond 2 Piece Agility Pole 1.5m Set of 12



RUBBER BASE AGILITY POLE KIT

Includes: 10 x Yellow or Orange Poles with Bag.

3456



AGILITY POLE BAG

Durable nylon roller bag has a full length zip for easy use, a central shoulder strap & handles on each end for tandem carrying.

34501PCE	1 Piece Agility Pole Bag - Holds up to 10
34502PCE	2 Piece Agility Pole Bag - Holds up to 10
30089	2 Piece Agility Pole Bag - Holds 4



AGILITY POLE IPC FIXED BASE

- One piece pole with fixed nickel-plated steel base spike
- High density PVC pole 25mm in diameter
- 1600mm high

30090	White
30091	Red
30093	Yellow
30094	Green
30095	Orange



AGILITY POLE IPC FIXED BASE SET OF 10

- Set includes 10 x 1 Piece Fixed Base Agility Poles and 1 x Agility Pole Carry Bag
- Nickel-plated steel base spikes
- High density PVC poles with a 25mm diameter and 1600mm height

30096	Yellow
30097	Orange



DIAMOND SUPERFLEX AGILITY POLE SET OF 10

- Dimension: 1m tall
- Material: Flexible PU tubing
- 1m tall completely bendable if fallen upon
- 10 white poles in a carry bag with fixed single spike for outdoor use

30098



DIAMOND TRAFFIC CONE POLE SET

- Dimensions: (15") 38cm Traffic Cones, 1m poles
- Materials: Plastic
- Set includes: 10 x 38cm Traffic Cones, 5 x 1m Poles
- Poles can be set at 3 different heights
- Perfect for Fitness & Agility training

30099



DIAMOND MULTI HURDLE SET OF 5

- Dimensions: Up to 60cm high
- Materials: Plastic
- Set of 5 Adjustable Hurdles in a carry bag
- Adjustable from 5 to 60cm in height
- UV treated plastic for a true colour
- Extremely versatile can be adjusted for height and angle

30086

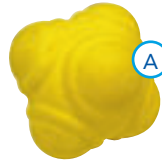

The irregular bounce of the Reaction Ball is perfect for improving reaction time, hand eye co-ordination & foot speed.

QUICKNESS

- 3457 A. Deluxe Reaction Ball
- 3451 Agility Belts Per Pair



DIAMOND DUO MANNEQUIN - YELLOW

- Dimensions: 5ft 4/5ft 11
- Materials: Plastic
- ABS Plastics 2 Piece Constructions, Spikes for Outdoor Use
- Can be adjusted to two different heights so is perfect for all age groups - revolutionary and versatile

30087



DIAMOND MANNEQUIN RUBBER BASE

- Dimension: Hold 1 Diamond mannequin
- Material: Rubber
- 8kg, universal for any Diamond Mannequin, will hold one mannequin
- Enables Diamond Mannequins to be used indoors, on astro or on hard surfaces.

30085



DIAMOND MANNEQUIN BAG

- Materials: Polyester
- Top quality, 600d polyester carry bag to hold up to 5 Diamond Pro Mannequins
- Shoulder strap for extra ease

30088



DIAMOND AGILITY POLE BASE INDOOR

- Dimensions: 1KG, holds 32mm poles
- Materials: Rubber
- Diamond pole base will accommodate any Diamond pole

DAPB01



PATRICK AGILITY POLE ZIG ZAG BASE

- Rubber agility pole base
- Centre hole for upright agility poles
- Outer two holes for angled agility poles for dodge drills

9126



PATRICK AGILITY POLE INDOOR RUBBER BASE DELUXE

- High density 2.5kg rubber base
- Replaces spike so agility pole can be used indoors
- Fits any Patrick 25mm pole with base spike removed

9125



RE-WRITABLE SIGN BOARD

Handy accessory which slides on to agility poles so you can leave instructions for your athletes without having to be at each pole. Type of exercise, number of repetitions and athlete names are all examples of what you can write with a standard whiteboard marker. Text can be easily erased, ready for the next session.

9124

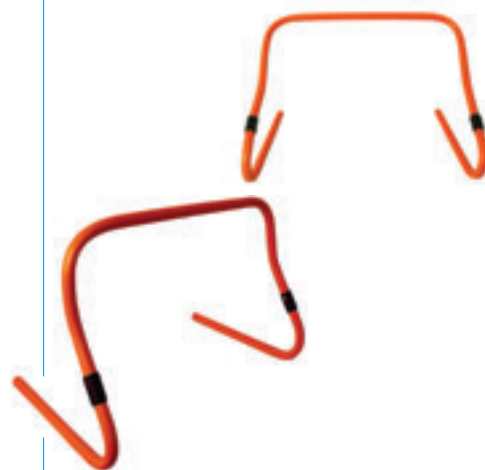
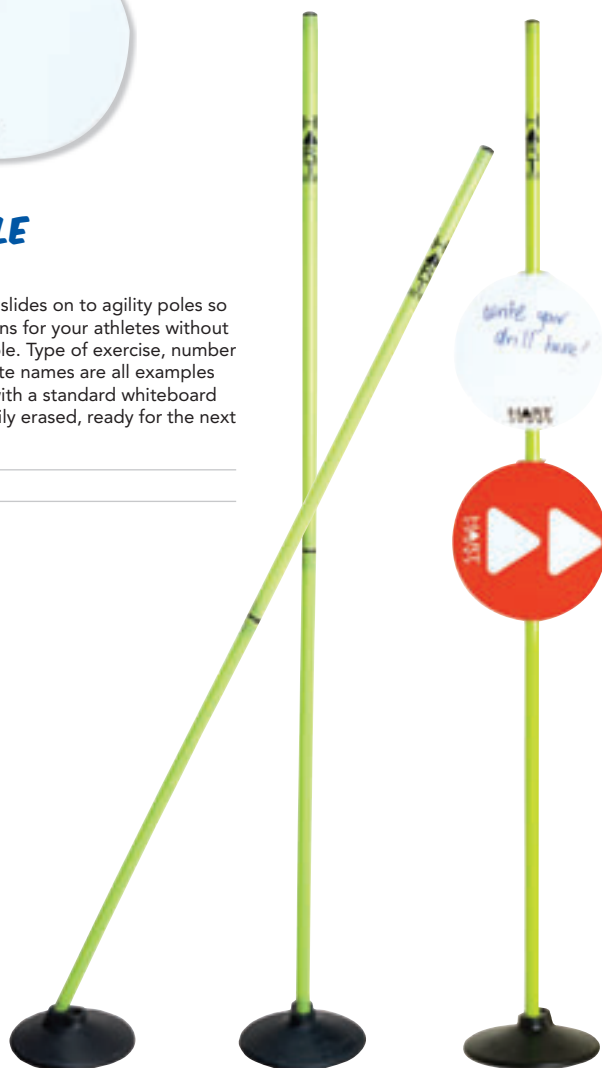

ADJUSTABLE SPEED HURDLE 15CM TO 30CM

100074 Adjustable 15cm to 30cm (6"-12")



ADJUSTABLE SPEED HURDLE 23CM TO 30CM

100075 Adjustable 23cm to 30cm (9"-12")

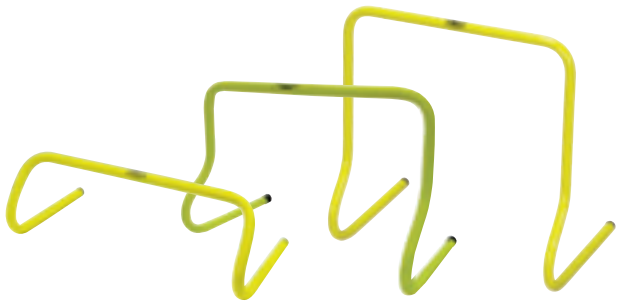

STEP SPEED HURDLE

Durable light weight PVC Hurdles. Great training aid for increasing foot speed, agility and lateral power.

3463	50cm High	Each
3462	45cm High	Each
3461	30cm High	Each
30050	23cm High	Each
3460	15cm High	Each

STEP SPEED HURDLE SETS SET OF SIX

Set of six durable light weight PVC Hurdles.

3472	45cm High x 6
3471	30cm High x 6

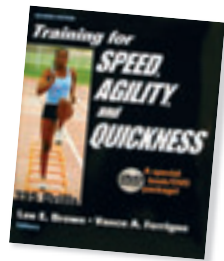

TRAINING FOR SPEED, AGILITY AND QUICKNESS BOOK

2109TFS



SPEED HURDLES 12" COUNTER BALANCE

- 30cm (12 inches) high
- Made from high density PVC with iron weight in top
- Counter balance enables hurdle to right itself when toppled

3473

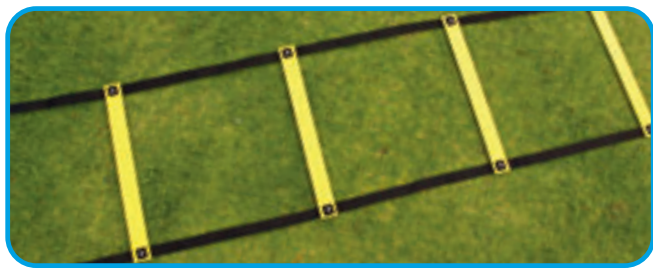

SPEED LADDER IN CARRY BAG FLAT 8M

3492



VELCRO HOLDER FOR HURDLES

- Made of nylon with velcro closure
- Carry handle
- Holds up to 10 speed hurdles
- Hurdles not included

1300

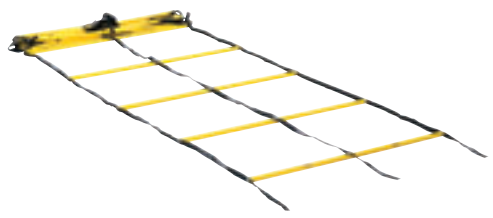

DOUBLE AGILITY LADDER

Double the challenge for your athletes. Ladders are 4.5m long with 11 tubular rungs spaced at 45cm intervals. Rungs are 81cm wide so each of the 20cm foot spaces are 45cm x 40cm. Ends of side webbing have hook & loop attachments so multiple ladders can be joined end to end.

Includes carry bag.

3490

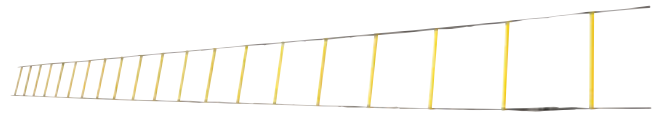

TUBULAR AGILITY LADDER

The hard wearing tubular plastic rungs provide instant feedback to the athlete. The rungs are spaced at 45cm intervals and form an 8.5m long ladder guaranteed to challenge foot control, balance and agility. Ends of side webbing have hook & loop attachments so multiple ladders can be joined end to end. Includes carry bag.

3491



DIAMOND SPEED LADDER - FLAT

- Dimensions: 2m & 9m
- Materials: Plastic with nylon webbing
- Easy grip handle, adjustable rungs
- Can be linked together with other Diamond Speed Ladder

30100 2m

30101 9m



PATRICK SPEED LADDER 8M - NYLON

- 2 x 4m ladder lengths that can be used separately or velcroed together into one 8m length
- Flat, thin, nylon covered rungs
- Rungs fixed to webbing sides
- Nylon carry bag for easy storage and portability
- Promotes agility and fitness

3499

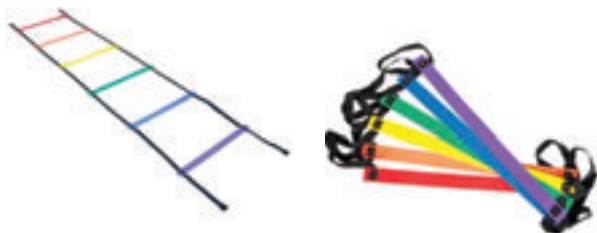

RAINBOW LADDER 2M

Add colour to your obstacle course with the HART Rainbow Ladder. Shorter 2m length for those with restricted space. Six bright coloured rungs are 42cm wide and spaced at 42cm intervals to allow for a bigger step area for beginners.

2016



FOAM FITNESS DICE

Add variety to your warm ups and workouts with these fun dice. Roll the dice and then perform the exercise and number of reps that come up. Set contains 2 foam dice with a PU coating. The 10 sided dice is printed with numbers 2 to 20. The Exercise dice features 10 exercises: Burpee, Lunge, Push Up, Star Jump, Dips, V-Sits, Plank Hold, Squats, Sit Ups and Tuck Jumps. Size: 18cm

6717H

Pair



RINGMASTER PVC EXERCISE MAT

- Supplied with velcro fastening strap and carry handles
- 2.54cm (1") Foam padding
- 15 Exercises printed on the mat
- Materials: PVC outer cover
- Colour: Black
- Size: 180cm x 60cm x 2.54cm

RPEM01

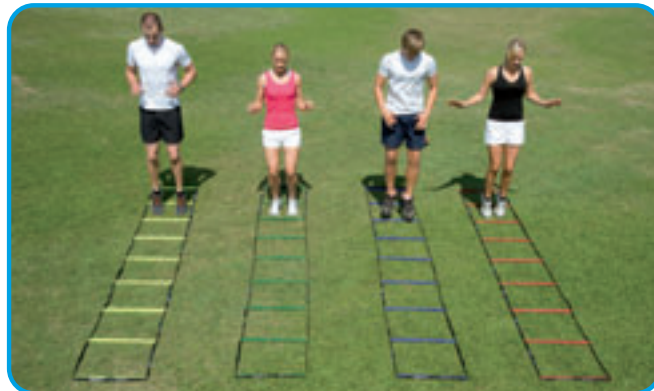

AGILITY LADDER X 4 COLOURS

4 different colour ladders in each set allow you to set up a huge variety of footwork pattern drills. Each ladder has hook & loop attachments so they can be joined together to form straight, square, triangle or cross formations. Red, Blue, Green and Yellow colours can be used as visual cues during drills or for team identification. Fixed round rungs are spaced 45cm apart. Carry bag included.

3494 4 x 2m

3495 4 x 4m



AGILITY RINGS

Create your own training patterns to develop agility, foot speed and leg drive. Set contains 12 x 50cm flat PVC hoops which can be used indoors or outdoors. The 12 x PVC clips allow you to keep the rings in position during drills. Includes carry bag.

3496 Set of 12



PATRICK SPEED RINGS SET

PATRICK Speed Rings come in a set of 8 rings. Can be used for a variety of different sports focussing on speed, agility & improve lateral movements & reactions times.

6282 Set of 8



PRO SPEED SLED

Heavy duty speed sled designed to develop powerful leg drive. Tow using the shoulder harness or use the handles to push the sled to develop hip and leg drive. Includes sled, shoulder harness and 3.7m lead. Suitable for Olympic style plate weights only. Plate Weight not included.

Size: 95cm(L) x 50cm(W) x 18cm(H) Weight: 14.5kg.

3510



PRO SPEED SLED LEAD

3.7m webbing lead with snaplock hooks. Designed specifically for HART Pro Speed Sled.

3511



SPEED SLED

Includes sled, resistor harness and 3.7m lead. Allows the athlete to sprint with their normal running form while overcoming consistent extra resistance. Size: 75cm(L) x 45cm(W) x 18cm(H) Weight: 3.5kg Plate Weight not included.

3512

SPEED SLED LEAD

Spare lead for Speed sled. 3.7m long webbing strap with snaplock hooks at each end.

3513



DUAL RESISTANCE TRAINER

Dual resistance training is excellent for sprint and agility training. Consists of two 75mm wide waist belts connected by a 2.7m long 38mm webbing strap. Includes Carry Bag.

3515

\$40.00



SPEED CHUTE

The speed chute will give you the speed strength necessary to run faster and in all directions without having a negative impact on technique as the chute allows you to run with correct form and at maximum speeds.

3516 Large-120cm Dia

3517 Medium-80cm Dia

DIAMOND SPEED CHUTE

- Materials: Nylon in carry pouch, velcro waist strap
- The Diamond Speed Chute is ideal for really testing the strength and fitness of your team
- The slip on harness has adjustable straps to fit all players
- Fantastic for resistance training

30102 Diamond Speed Chute



SPEED RESISTOR

Resisted sprinting is the most simple and effective means of adding a load to your sprinting motion. This Speed Resistor helps develop speed and acceleration for the sprinter, while working the "holder" eccentrically to develop stopping strength.

3519M Medium Harness

3519L Large Harness



SHOULDER HARNESS

Chest/shoulder harness with a stainless steel ring for sled lead or catapult cord attachment.

3520



WAIST BELT

75mm wide adjustable belt with stainless steel ring. Suitable for use with Catapult Trainer, Dual resistance Trainer, Power Builder & Speed Sled.

3521



CATAPULT TRAINER

Includes two waist belts and one bungy style flexicord. The athlete is pulled faster so they are forced to increase stride rate and length. The rate of the overspeed is easily controlled by the starting stretch placed on the tubing. 3m trainer is great for indoors or where space is limited.

3523 6m

3524 3m

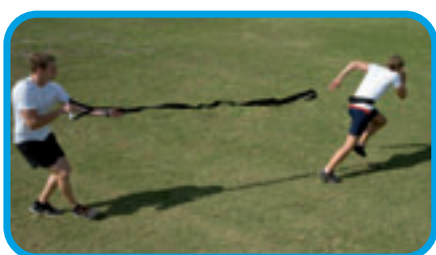

AGILITY BELT

Read, react, evade and defend! The agility belt is unmatched for one on one evasive skills, reactive speed and fun fitness training. Perfect for football, netball, basketball and any sport that requires short space defending and stepping. Includes two waist belts with connecting leads. Each lead has two hook and loop tabs for attaching athletes different distances apart.

3525



QUICK RELEASE HARNESS

The holder provides braking resistance to the sprinter before activating the quick release mechanism which allows the sprinter to explode away. Fantastic device for developing power running and explosive acceleration. Consists of one waist belt and one 2.7m lead with PVC handle and quick release strap. Includes carry bag.

3522



LATERAL STEP TRAINER

Improves lateral speed, balance and speed off the mark by increasing the muscle load specific to sideways movement. Great for one on one drills, warm ups and improving upper leg strength.

3526 Heavy

3527 Medium



POWER SLED

The monster of all sleds! This heavy duty sled can be pulled using a harness and lead, pushed using the vertical plate racks or pushed using the two horizontal bars.

Features:

- Sturdy frame made of 60mm x 60mm steel tubing.
- 3 ring attachments for towing
- 6mm steel shoes that can be used on any surface (can be replaced if necessary)
- Detachable chrome plated plate stacks (suitable for Olympic Plates only)
- Weight: 27kg
- Weight plates are not included.

3550



SPEED TRAINING KIT

Improve your speed with the HART Speed Training Kit.

It includes a variety of speed training equipment which all fits into a handy bag so you can take it to every training session.

The HART Ladders and Hurdles will improve coordination, lateral movement and footwork. The speed Chute and Resistor will help develop speed and acceleration in your running technique.

- Flat Agility Ladders 4m - 9 Rungs 1
- Step Hurdle - 15cm 6
- HART Speed Resistor 1
- HART Speed Chute Large 1
- Jersey Bag / Back Sack 1

3560



AGILITY TRAINING KIT

This kit will help you develop agility, foot speed, reaction and quickness for all sports. Includes DVD with 100's of drills and handy carry bags for all the equipment.

Includes: 10 x Agility Pole - Two piece, 1 x Agility Pole Bag, 6 x Step Hurdles - Micro, 1 x Hurdle Carry Bag, 1 x Agility Belt, 1 x Agility Ladder - Tubular, 1 x Lateral Step Trainer - Med, 1 x Speed for Sport Basics - DVD, 1 x Super Reaction Ball Set

3562



PORTABLE PT PACK

HART Portable PT Pack is for the trainer on the go as all the equipment will easily fit into the back of your car with hardly any set up time. The pack includes all the fundamental equipment needed to create a vigorous and fun workout.

30103



Ringmaster

Est. 1972

TRAINING AIDS





ONYX BODY ROLLER

This stylish foam roller features a hollow, hard PVC pipe with a 13mm EVA foam overlay. The extra firm feel, combined with the moulded pattern foam is ideal for myofascial release. The hollow pipe makes it easy to travel with and also aids in shape retention.

3552



FOAM REACTION BALL

Huge foam reaction ball great for kids! PU covered foam makes this a safe, fun reaction ball while still providing all the challenges that irregular bounce provides. 24cm diameter.

3572

Each



RINGMASTER EVA FOAM ROLLER

- Eco-friendly, lightweight, anti-slip and durable
- Widely used in pilates, yoga, physiotherapy and rehabilitation
- A great self massaging roller, targets specific muscle groups to help & assist myofascial release
- Can be used all over the body to target specific soreness. Once you get the hang of rolling it will become part of your everyday routine
- Material: EVA

30104 45cm Roller

Each

30105 90cm Roller

Each



RINGMASTER EVA FOAM ROLLER EXTRA FIRM 33CM

- Extra Firm for hard pressure self massage
- Improves balance, core stability, flexibility & strength
- Eco-friendly, lightweight, anti-slip, durable

30106 33cm Roller

Each



REACTION BALL

Irregular bounce is perfect for improving reaction time, agility, foot speed and hand/eye co-ordination. The six sided ball will bounce with speed in any direction after it hits the ground. Best used on a firm surface.

3566 **Hard** - Quick Small 7cm

Each

3567 **Hard** - Large 10cm

Each



SUPER REACTION BALL SET

These reaction balls are extra firm and super fast to create even more challenges for athletes. Set contains a Blue, Red, Green and Yellow ball so you can design your own decision making drills. Includes carry bag. Diameter of balls: 7cm.

3570 Set of 4

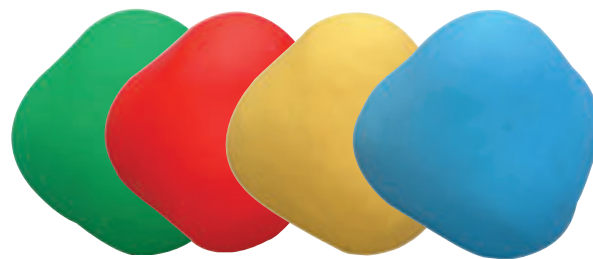

PYRAMID BALL

Suitable for juniors. Great way to introduce the basics of reaction times, split step and hand/eye coordination due to erratic bounce. Inflatable, pliant rubber. Pyramid shape. Size: 16cm.

3571G Green

Each

3571R Red

Each

3571Y Yellow

Each

3571B Blue

Each



STANDARD DOME BASE

Holds posts only. Bases can be filled with sand or small pebbles to provide stability.

3583 Each



SUPER DOME BASE

Holds posts, round hoops and flat hoops. Bases can be filled with sand or small pebbles to provide stability.

3584 Each

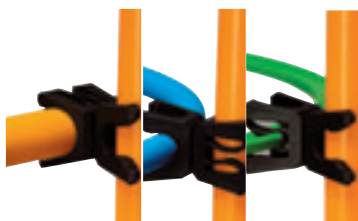

SUPER CONNECTORS

These versatile 3-way connectors are used for joining together poles and hoops (both flat & round hoops). These Super Connectors are only suitable for this range of products.

3585 Each



POLES

One 1600mm pole. Comes in two pieces. 25mm diameter.

3586 Each



TRAINER CONES

Moulded notches on top of these cones allow poles to sit snugly.

3588 8cm High Each



MULTI USE WITCHES HATS

Durable plastic 50cm high. Suitable for use with poles or flat hoops or clip on ladders. Four holes on four sides.

3590 Each



STRENGTH BAG

- Tough Nylon coated fabric for durability
- 3 thick heavy duty handles allowing for a variety of different lifts
- Pre-filled inner bag to correct weight

30107	10kg - Green/Black	Each
30108	15kg - Blue/Black	Each
30109	20kg - Red/Black	Each

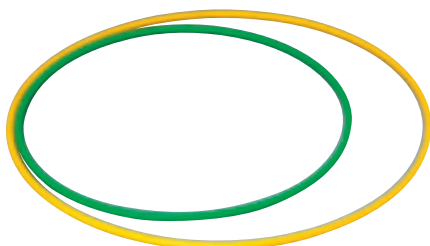

ROUND HOOP

3592	60cm	Each
3593	90cm	Each

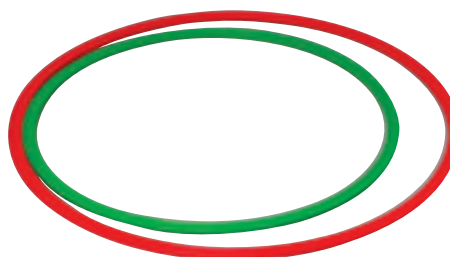

FLAT HOOP

3594	60cm	Each
3595	70cm	Each



FOAM PLYO HURDLES

Great for Plyometric training, Lateral Agility drills, or any hurdle drill or obstacle course where safety is important. These foam hurdles are soft enough to break a fall, yet strong enough to be used in any conditions. Lightweight to carry and made with a high density, top grade foam covered in a heavy duty tarpaulin vinyl which is UV treated. Width of each hurdle is 60cm.

3600	30cm High
3601	45cm High
3602	60cm High
3603	75cm High



DOME KIT

Great for plyometric and agility training. Hinged joint rotates 360 degrees. Crossbars can be set to any height or angle. Bases can be filled with sand or small pebbles to provide stability. Can also be used indoors as is, or as agility poles. 4 x Domes with Caps (fillable), 6 x Poles (two piece), 4 x Standard Connectors

3580

FOAM PLYO HURDLES SET

Includes one plyo hurdle in each size: 30cm, 45cm, 60cm and 75cm

3604	Set of 4
------	----------



PLYO BOXES

Improve speed and explosive power while performing basic drills including forward and lateral jumps and advanced single leg jumps. Use the varying heights or vary the spacing between boxes to increase or decrease the exercise intensity. Tops have a non-slip surface to maximise safety. Stackable for easy storage and suitable for use indoors and outdoors.

3605	Set of 4
------	----------



MINI HURDLE CONE SET

Allows hurdle to be adjusted from 12cm - 85cm high. 2 x Multi-use Witches Hat, 2 x Clip on Ladder, 1 x Pole - 1 metre

3581

ACROMAT

ACROMAT

SLATER-GARTRELL SPORTS WA AGENT

Acromat is now recognised as a world leader in gymnastic and sporting equipment, with the Acromat's performance finely tuned to match the high expectations of athletes at all levels of competition. To ensure the needs of gymnasts and athletes are met, especially in the critical areas of engineering strength and safety, we design much of our equipment in close consultation with leading coaches.

Please forward all enquiries to: sales@slatertrellsports.com.au

Note: For Universal Mats & Tumbling Runs there will be a bulk freight fee.

Please contact us for a freight costing.

This range of carpet covered Tumbling Runs and Mats are a versatile product that can be used for all types of activities. For safe plyometric bounding, this style of mat is unsurpassed for suitability and quality. The closed cell crosslinked polyolefin foam has exceptional & unique rebound qualities. Ideal for multipurpose exercise areas for schools and gymnasiums. The foam is covered in an easy to clean 2mm plush carpet. It is UV stabilized and guaranteed to last. Choose a mat or strip to suit your facilities needs.



UNIVERSAL MAT

3610 2m x 1m x 42mm

JOINING TAPE

Join multiple mats together to form large exercise areas.

3611 Per Metre

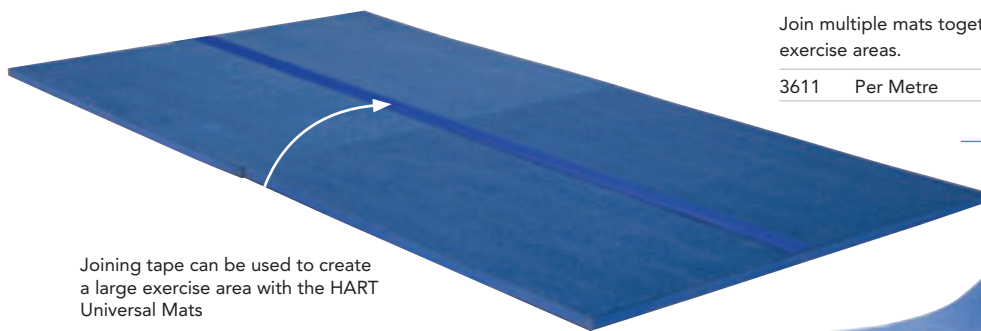

Joining tape can be used to create a large exercise area with the HART Universal Mats



TUMBLING RUNS

Please allow 2 - 3 weeks for despatch.

3612 14m x 2m x 32mm

3613 13m x 2m x 32mm

3614 6.5m x 2m x 32mm

3615 13m x 1m x 32mm



2mm plush carpet

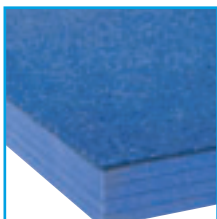

Closed cell crosslinked polyolefin foam



WRIST & ANKLE WEIGHTS

Mesh outer casing for superior comfort and breathability. Hook and loop closure ensures a snug fit. Can be used on ankles or wrists.

3632	2 x 500g
3633	2 x 1kg
3634	2 x 1.5kg
3635	2 x 2kg



Weight vest helps build core strength, endurance & power.

Durable nylon vest with padded shoulders.

Double crossover hook and loop closures provides snug fit.



WEIGHTED EXERCISE VEST

The HART Weighted Vest evenly distributes weight during exercise, promoting better technique and maximum comfort. This versatile training tool is a great way to add resistance when doing bodyweight dips or using chin-up bars. If weight adjustments are required, individual weights can easily be removed a maximum of 2.5kg of extra weight can be added. =

- Snug fit with adjustable straps.
- 10kg vest: 38 soft 255g weights.
- 20kg vest: 38 soft 508g weights.
- One size fits most.

3622	10kg
30110	20kg



SPARE WEIGHTS FOR EXERCISE VEST

Spare weights to suit 5kg and 10kg weighted vests. Pack includes: 10 x 250g weight bags and carry bag. Individual bag size: 110mm x 43mm.

3623

Please visit www.slatergartrellsports.com.au for up to date pricing.

CUSTOM TEAMWEAR

**YOUR TEAM OR CLUB CAN NOW
LOOK LIKE TRUE PROFESSIONALS.**

Slater-Gartrell Sports clothing range offers a combination of high performance fabrics in conjunction with a comfortable and functional fit to meet a player's match and training kit requirements at every level.

Slater-Gartrell Sports understands the needs of teams and our range of high performance stock match shirts, training wear and leisure garments combined with an extensive range of customised options cater for every scenario.

Our specialised design team can assist and advise on every aspect of incorporating your specific school, club or university colours onto any garment.

Our embroidery and printing facilities allow quick turnaround on stock items which can all be embellished with your club logo, numbers and or sponsor logo.



**SLATER-GARTRELL
SPORTS**



10KG WEIGHT BELT

Add load to your gym or field workouts quickly and easily with this weight belt. Contains 10 x 1kg removable weights and the external pockets allow you to easily adjust the weight to suit your individual needs. Adjustable hook & loop closure for a secure fit.

3624



FITNESS, SPEED & AGILITY



WEIGHTED JUMP ROPE

Create a heavy duty skipping workout with this 11mm thick solid PVC rope with swivel handles. Rope is 2.7m long and weighs approx 500g

3631

Please visit www.slatergartrellsports.com.au for up to date pricing.



AERO BALL BARREL

Holds 100 Balls.

8001



AERO BALL SACK

Holds 50 Balls.

8002



FLOORBALL MATCH BALL

8003



CAMPUS COACH TOOL BAG

Holds 24 Floorball Sticks.

8004



1600 FLOORBALL GOAL CAGE

Full Size Floorball Goal.

8005 1600mm Wide Each



FOLDABLE FLOORBALL GOAL CAGE

8007	900mm x 600mm	Each
8008	600mm x 400mm	Each



FLOORBALL 55 SCHOOL SET - MATCH

Includes: 6 x Orange Sticks & 6 Green Sticks.

8009 85cm Sticks
800995 95cm Sticks



FLOORBALL 34 SCHOOL SET - DELUXE

Includes: 5 x Blue Sticks & 5 Red Sticks.

8010 85cm Sticks
801095 95cm Sticks



XPLODE 30 STICK IFF APPROVED

8011	92cm Stick	Each
8012	96cm Stick	Each



SALMING PHOENIX ELITE GOALIE HELMET BLACK

SAL001K



SALMING PHOENIX ELITE GOALIE HELMET WHITE

SAL001W



SALMING TEMPISH HERO I-SEE COLOUR GOALIE HELMET

SAL002



SALMING GOALIE PROTECTIVE VEST E-SERIES

SAL003



SALMING GOALIE PROTECTIVE SHORTS E-SERIES

SAL004



SALMING GOALIE PROTECTIVE KNEE PADS E-SERIES

SAL006



SALMING GOALIE PROTECTIVE ELBOW PADS

SAL009



SALMING ATILLA GOALIE GLOVES

SAL007



SALMING HAWK GOALIE GLOVES

SAL008

Please visit www.slatergartrellsports.com.au for up to date pricing.

Burley - Footballs Since 1907

Burley is officially endorsed and used by the WAFL, SANFL, Victorian Country Football League, WA Country Football League, the Victorian Women's Football League and the Foxtel Cup.



Our reputation for impeccable quality is in part due to the vast experience of our manufacturing department. Every Burley football must first meet strict standards of quality before they can leave the Burley factory.

Premier - Vegtan

Designed primarily for use in top grade leagues and competitions. The 'Premier' is made using the finest leather hides, selected only after passing Burley's rigorous quality testing. This world class football is used extensively among Australia's footballing elite.

4001 Size 2: 10-11 Years Red 4002 Size 3: 12-13 Years Red
4003/R/Y Size 4: 14-15 Years Red or Yellow 4004/R/Y Full Size : Red or Yellow



Premier - women's

Burley produces match quality leather footballs for use in women's leagues around Australia. Smaller and lighter than a full size footy, the women's ball is designed specifically for the smaller feet and slighter frames of the average female, allowing greater skill development than ever before.

4010R Size 4: Red 4010Y Size 4: Yellow 4010P Size 4: Pink

< **Pride of Quality in Every Ball** >



Club

The Burley 'Club' ball is produced using quality Australian leather, second only to that used for the Burley 'Premier'. The 'Club' is a match quality ball ideal for amateur league teams, but great value for football clubs at any level.

4020 Size 2: 10-11 Years Red 4021 Size 3: 12-13 Years Red
4022/R/Y/W Size 4: 14-15 Years Red, Yellow or White
4023 Full Size : Red Yellow or White



Match

'Match' balls are made from fine pre-stretched Indian leather, making it perfect for use in junior matches. A long lasting ball, the 'Match' is suitable for all ages and is used extensively in junior leagues.

4024/R/Y Size 2: 10-11 Years 4025/R/Y Size 3: 12-13 Years
4026/R/Y Size 4: 14-15 Years 4027/R/Y Full Size



League

Introduced to the Burley range in 2010, the 'League' is an Indian leather football of comparable quality to Australian made balls - an industry first. Featuring excellent shape retention and quality hide with the benefit of an imported football price.

40283 Size 3, 40284 Size 4 or 40285 Size 5



Attack

Burley's 'Attack' is made from waterproof, synthetic material, making it an all-weather ball usable on any surface. A pebble grain exterior allows for better grip and easier marking, making it ideal for primary schools and beginners still learning the basics.

4029/R/Y Size 1: 5-9 Years Yellow 4030/R/Y Size 2: 10-11 Years

4031/R/Y Size 3: 12-13 Years Red or Yellow 4032/R/Y Size 4: 14-15 Years

4033/R/Y Full Size:



Soft Touch

A revelation with young girls and boys in recent times, the soft touch's soft PVC outer makes it perfect for young hands and feet, and play without shoes.

4034R/Y/R/P Size 1:

4035R/Y/R/P Size 3:



Club Coloured Balls

Burley 10" and 12" footballs feature a modern design and are embossed with the Burley logo for easy grip.

Available in 15 popular colour combinations. 4036/TEAM Full Size: 4035/TEAM Club 10":



GUERNSEYS, JERSEYS, SHORTS,



Quality sporting apparel since 1923

Sekem is Australia's market leader in football guernseys being the only company licensed to manufacture all 18 AFL team replicas.

In teamwear, Sekem caters for all levels and ages from our high spec – Legend jumper for the elite level to our Match garment for more budget conscious clubs.



LEGEND



- Coolflo stretch fabric
- Very tight fitting spec
- GPS pocket
- High neckline & reduced armhole, making tackling hard
- Designed for elite players
- Scooped hem



coolflo



coolflo



PREMIER

Coolflo stretch fabric
Very tight fitting
Traditional V neck design
Scooped hem

Mens: XS - 4XL | Boys: 6-12

From: \$70.00

ELITE

Coolflo stretch fabric
Fitted spec
Tab style neck
Scooped hem

Mens: XS - 4XL | Boys: 6-12

From: \$65.00

CLUB

Standard cut and fabric
V neck
Scoop or flat hem

Mens: XS - 4XL | Boys: 6-12

From: \$45.00

MATCH

Standard spec and fabric
Budget option
Flat hem

Mens: XS - 4XL | Boys: 6-12

From: \$40.00



SOCKS, NETBALL, TEES...



WOMEN'S LEAGUE

Women's fit, flat hem, vee neck & printed trims
Standard or Premier women's cuts available.

From: \$50.00

FOOTBALL SHORTS

Plain colour, fully sublimated, colour combinations, custom print braids and printed branding logos are available.
Women's League shorts available in Standard and Premier

From: \$23.00

SPORT SOCKS

The Sekem range includes the popular Elite nylon/elastane high performance sock, superior fitting long knitted sock and the all new ankle length training sock,

From: \$8.00



Knitted / Long Sleeve



Sublimated / Cotton Collar



RUGBY JERSEYS

Sekem's long history of rugby jersey production means your guaranteed quality in either the traditional knitted or fully sublimated designs. For match or casual wear.

From: \$59.00

RUGBY SHORTS

Plain colour, fully sublimated, colour combinations, custom print braids and printed branding logos are available.

From: \$32.00



NETBALL UNIFORMS

Fully sublimated polyester with a variety of fabrics available.
Design your own unique look for your team.

From: \$70.00



POLO TOPS

Sublimated polyester or 'cut & sew' polo with a variety of fabrics available.
Design your own sublimated polo for school tours, uniform or casual use.
Short & long sleeve.

From: \$39.00



SPORTS TEES & SINGLETs

Play or train in style in Sekem's range of singlets, soccer, hockey or multi sport tops. Fully sublimated, your team will shine in their unique design.

From: \$35.00





SHERRIN IS THE OFFICIAL BALL OF THE AUSTRALIAN FOOTBALL LEAGUE SINCE 1897



SHERRIN FOOTBALLS

4100	Sherrin KB Red - AFL Full Size
4101	Sherrin KB Yellow - AFL Full Size
4102	Sherrin KB White - Training Full Size
4103	Sherrin Match Full Size

SHERRIN SOFT TOUCH FOOTBALLS

4110	Sherrin AFL Soft Touch Mini
4112	Sherrin AFL Soft Touch JNR
4113	Sherrin AFL Soft Touch Youth

SOCKS PER DOZEN

4180	Kingsize
4181	Size 7-11
4182	Size 2-8
4183	Size 13-3 junior



POST PADDING FULL VELCRO WRAP-AROUND

4160	1800 x 390mm (each)
4161	1800 x 480mm (each)

POST PADDING CYLINDRICAL

Available in White or Royal Blue.

4163	1800mm x 100mm ID (each) - White
4163R	1800mm x 100mm ID (each) - Royal Blue
4164	1800mm x 120mm ID (each) - White
4164R	1800mm x 120mm ID (each) - Royal Blue
4165	2500mm x 100mm ID (each) - White
4165R	2500mm x 100mm ID (each) - Royal Blue
4166	2500mm x 120mm ID (each) - White
4166R	2500mm x 120mm ID (each) - Royal Blue

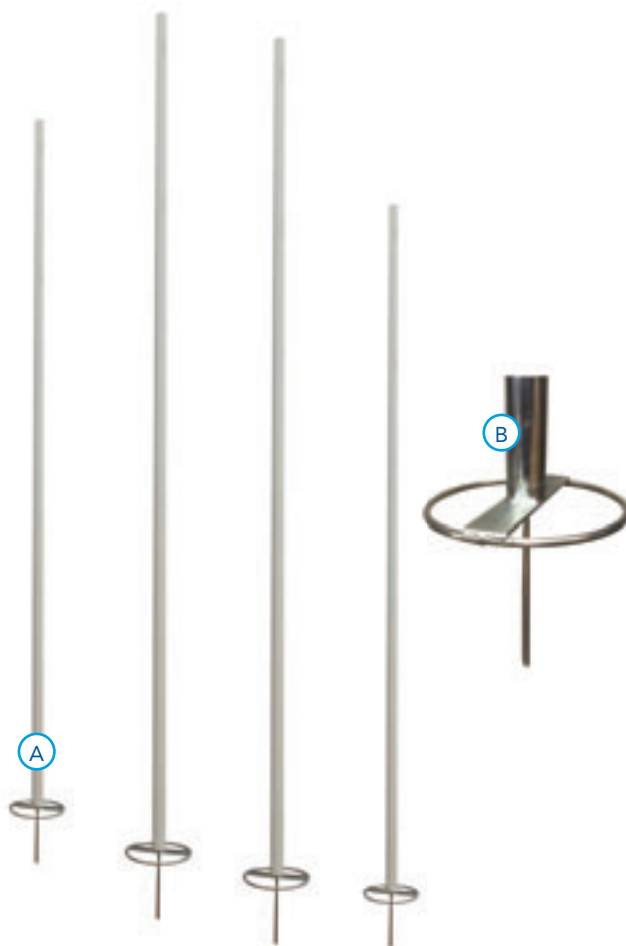

PVC AFL GOAL POSTS

4150	A. Portable PVC 4 posts - 1 End (G: 3.5m & P: 2.5m)
4152	B. Spike Only
4151	Telescopic with Water Filled Base - 1 end



ARCTIC HEAT COOLING VESTS

The Arctic Heat Cooling Vest is a revolutionary product designed to counter the harmful effects of heat stress. It is fast becoming an essential piece of sporting equipment for athletes seriously seeking a competitive edge.

3040BS	Small - Blue
3040BM	Medium - Blue
3040BL	Large - Blue
3040BXL	XL - Blue
3040B2XL	XXL - Blue
3040B3XL	XXXL - Blue
3040B4XL	XXXXL - Blue
3040B5XL	XXXXXL - Blue



ALLIANCE PORTABLE GOAL POST SET

- Set of 4 Poles and Carry Bag
- Goal Post Length: 1.81 meters
- Behind Post Length: 1.58 meters
- Add extra 170mm to posts with spring of spike attached

4171



ALLIANCE HANDBALL TARGET

- Australian Rules Football Training Aid.
- The A-Frame adjustable 'Handball Target' is ideal for handball practice for all ages, Beginners to Advanced.
- The Handball Targets have adjustable settings, This enables the Height to be altered according to the age of the participant.
- Target Mat Dimensions: 1m Height x 1m Width.
- Full Length Dimensions: (H) 160cm x (W) 100cm.
- Adjustable Height Settings.

AHT01



BUFFALO WATER COOLER

- Heavy duty food grade plastic
- Lid, side handles, front tap
- Ideal for the bench or drinks intervals
- Easily cleaned

4200	43 Litre Size
4200S	20 Litre Size



RELIANCE SUPERLITE HEADGEAR

- Suitable for Football

RSH001



SG FOOTBALL HELMET

- Suitable for Football

SGFBH



PATRICK DUAL ACTION PUMP

- Dual action: expels air on both push and pull actions
- Ball inflation valve and toning ball adaptors included

30037

CUSTOM TEAMWEAR

**YOUR TEAM OR CLUB CAN NOW
LOOK LIKE TRUE PROFESSIONALS.**

Slater-Gartrell Sports clothing range offers a combination of high performance fabrics in conjunction with a comfortable and functional fit to meet a player's match and training kit requirements at every level.

Slater-Gartrell Sports understands the needs of teams and our range of high performance stock match shirts, training wear and leisure garments combined with an extensive range of customised options cater for every scenario.

Our specialised design team can assist and advise on every aspect of incorporating your specific school, club or university colours onto any garment.

Our embroidery and printing facilities allow quick turnaround on stock items which can all be embellished with your club logo, numbers and or sponsor logo.



**SLATER-GARTRELL
SPORTS**



SHOCK DOCTOR PRO STRAPLESS

Our sports mouth guard is suitable for all contact sports where a mouth guard is required or recommended like: football, basketball, lacrosse, hockey, MMA, boxing, jiu jitsu and much more. Boil & bite fit provides a comfortable fit and can be reformed as needed. Shock absorbing front bumper protects against impact.

SD001	Youth
SD002	Adult



SHOCK DOCTOR GEL MAX STRAPLESS

The Gel Max mouthguard delivers essential protection and comfort with a convertible tether that allows the mouthguard to be used strapped or strapless. This triple layer mouthguard provides a universal fit for all ages. Classic Fit: Traditional and original, all-around performer. Gel-Fit liner for tight, comfortable fit.

SD003	Youth
SD004	Adult



SHOCK DOCTOR GEL MAX FLAVOUR FUSION

The Gel Max Flavour Fusion Mouthguard delivers essential protection and comfort. This triple layer mouthguard provides a universal fit for all ages. Classic Fit: Traditional and original, all-around performer. Gel-Fit liner for tight, comfortable fit. Flavour Fusion Technology

SD005	Youth - Fruit Punch
SD006	Youth - Bubblegum
SD007	Youth - Lemon Lime
SD008	Youth - Blue Raspberry
SD009	Adult - Fruit Punch
SD010	Adult - Bubblegum
SD011	Adult - Lemon Lime
SD012	Adult - Blue Raspberry



SHOCK DOCTOR MICROFIT

Designed to provide the best 2.4 mm protection, this nextgen 2.4 mm mouthguard is a thin low profile fit design. A slim fit provides ultimate easy breathing and speaking with I-Mold technology for smooth contour and a high level of comfort after forming the mouthguard to each athlete's unique preference for fit. HMW Composite Blend for increased durability while maintaining fit and performance all season long. Slim Fit: Less material, lower profile, better breathability. Ultra custom fit, forms uniquely to your mouth. Best 2.4 mm Mouthguard in the market. Greatest deal on 2.4 mm max low profile guard. Lowest profile for easy breathing & speaking.

SD013	Adult
-------	-------



SHOCK DOCTOR SUPERFIT BASKETBALL

Communicate better with highly breathable and speak-able InVent tech. Developed to handle the hard court, hard elbows and hard shots of basketball. Sink into full coverage, ultra comfort and easy fitting...aka, Super. Sport Fit: Specialty models best used with certain sports. For enhanced court-running breathability & speak-ability. Light & tight custom protection.

SD014	Youth
SD015	Adult



SHOCK DOCTOR ULTRA BRACES

Ultra protection for athletes with braces. The Ultra Braces mouthguard outperforms conventional mouthguards through the genius combination of adjustability and durability in one package. The Insta-Fit Plus™ system allows athletes to mold and remold the mouthguard as teeth continue to adjust throughout orthodontic treatment. Braces Fit: Specifically developed for use with orthodontics. Triple layer protection for braces wearers. Moldable and remoldable after bracket adjustment.

SD016	Youth
SD017	Adult

SHOCK DOCTOR NANO DOUBLE FIGHT

Nano protection for upper and lower teeth for high impact sports. Perfect for MMA Fighters, Boxers and Jiu-Jitsu. This dual-arch, low profile mouthguard is designed to enhance upper and lower jaw protection. Featuring a double monocoque shock frame, it absorbs and disperses impact away from the point of contact. Classic Fit: Traditional and original, all-around performer. High-impact technology for high-impact sports. Protects, stabilizes both upper & lower teeth/jaw.

SD019	Youth
SD018	Adult





INFLATOR NEEDLES

4250	Thick	Each
4251	Thin	Each



SUPER COMPRESSOR INFLATION NEEDLES 3 PACK - THICK

- Wide threaded section
- Packet of 3
- Thin needle suitable for small valve inflatables

30033



SUPER COMPRESSOR INFLATION NEEDLES 12 PACK - THICK

- Wide threaded section
- Packet of 12
- Thin needle suitable for small valve inflatables

30034



HAND PUMP HEAVY DUTY

4242



BALL INFLATION NEEDLE 3 PACK - THIN

- Suitable to inflate Basketballs, Netballs, Soccer Balls, Volleyballs
- Suitable for small valve inflatables
- Blister pack of 3 needles

30035



BALL INFLATION NEEDLES 12 PACK - THIN

- Suitable to inflate Basketballs, Netballs, Soccer Balls, Volleyballs
- Suitable for small valve inflatables
- Blister pack of 12 needles

30036



COMPRESSOR HEAVY DUTY

4243	Compressor
4245	Replacement Compressor Hose



COMPRESSOR DELUXE

4244	Compressor
4245	Replacement Compressor Hose



HAND PUMP STANDARD

4249



GOAL UMPIRE FLAGS

4240 Pair



GOAL UMPIRE COAT

4241



PATRICK DUAL ACTION PUMP

- Dual action: expels air on both push and pull actions
- Ball inflation valve and toning ball adaptors included

30037



BLADDERS

- 4255 Full Size
- 4256 Mini

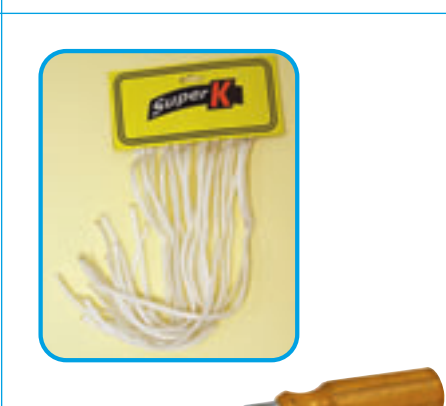

LACING ACCESSORIES

- 4257 Lacing AWI
- 4258 Lacing Card - Pack of 10



AIR HORN PUMP ACTION

Pump action operation with high sound output.
1271



AIR HORN COMPLETE KIT DELUXE

Acoustic horn signal. Push button plastic top air horn. Includes 300ml aerosol can.

- 1274 **A.** Air Horn Complete Kit
- 1275 **B.** Air Horn Refill Can 300ml



AIR HORN COMPLETE KIT STANDARD

Acoustic horn signal. Push button plastic top air horn. Includes aerosol can in kit.

- 30015 **A.** Air Horn Complete Kit
- 30016 **B.** Air Horn Refill Can
- 30017 **C.** Replacement Horn



CURVED LARGE BUMP PAD

- 5101R Red
- 5101B Royal Blue



STRAIGHT LARGE BUMP PAD

- 5106R Red
- 5106B Royal Blue
- 5106N Navy
- 5106Y Yellow



STRAIGHT XL BUMP PAD

- XLBPR Red
- XLBPB Royal Blue
- XLBPN Navy
- XLBPY Yellow



CURVED BUMP PAD

- 5105R Red
- 5105B Royal Blue
- 5105N Navy
- 5105Y Yellow



RUCK BAG XL

- 5108C Royal Blue
- FBTARXL03 Red



MOBILE RUCK BAG WITH LEDGE

- 5109R Red
- 5109B Royal Blue
- 5109N Navy



RUCK BAG WITH HANDLES

- RBWHR Red
- RBWHB Royal Blue



SQUARE BUMP PAD LARGE

- 5107R Red
- 5107B Royal Blue
- 5107N Navy
- 5107Y Yellow



FOREARM CURVED BUMP PAD

- 5100R Red
- 5100B Royal Blue
- 5100N Navy



CONVEX BUMP PAD

5104R Red

5104B Royal Blue

5104N Navy



CONCAVE BUMP PAD

5102R Red

5102B Royal Blue

5102N Navy



DIAMOND PROTECTIVE SHIELD

5103R Red

5103B Royal Blue

5103N Navy



MEDIUM TACKLING BAG

- Heavy duty vinyl cover
- High density foam core
- Reinforced suede handles

5112R Red - 1200mm x 350mm

5112B Royal Blue - 1200mm x 350mm

5112N Navy - 1200mm x 350mm

5112Y Yellow - 1200mm x 350mm



LARGE TACKLING BAG

- Heavy duty vinyl cover
- High density foam core
- Reinforced suede handles

5111R Red - 1500mm x 400mm

5111B Royal Blue - 1500mm x 400mm

5111N Navy - 1500mm x 400mm

5111Y Yellow - 1500mm x 400mm



EXTRA LARGE TACKLING BAG

- Heavy duty vinyl cover
- High density foam core
- Reinforced suede handles

5110R Red - 1800mm x 450mm

5110B Royal Blue - 1800mm x 450mm

5110N Navy - 1800mm x 450mm

5110Y Yellow - 1800mm x 450mm

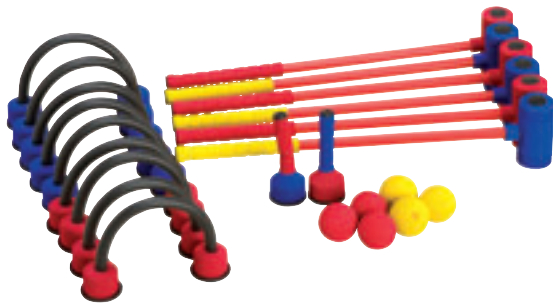

FOAM CROQUET SET

Game can be set-up anywhere - indoors or outdoors. Unique weighted foam-covered wickets stay upright while still remaining soft and flexible. Includes 6 mallets (670mm L), 6 balls (62mm diam), 9 wickets, 2 stakes and a vinyl storage bag with handle.

33064



CROQUET SET DELUXE

- Alliance Croquet Set Deluxe
- Set Includes: Wicket, Stakes, Mallets, Balls & Carry Bag

GAC5 Alliance Croquet Set Deluxe



FRISBEE GOLF BASKET

Very popular worldwide game suitable for all ages. Portable target is 132cm high and 60cm diameter. The twelve pieces of chain allow the frisbee discs to drop in to the basket. Includes 4 metal stakes to secure to ground.

16140



ALLIANCE CROQUET SET 4 PLAYER

The Alliance Croquet Set 4 Player is your gateway to hours of backyard fun. Designed for beginners, this set comes complete with four vibrant wooden-look plastic mallets, durable hard plastic balls, six sturdy metal hoops, a wooden winning post, and rules to get the game rolling. Plus, it's conveniently packed in a zip-fastening bag for easy storage and transport.

GACS4



FRISBEE GOLF DISC SET

Set of 3 Frisbee discs designed especially for Frisbee Golf. The Driver disc is designed for long range shots off the tee. Use the Mid-range disc for more accurate shots at the target and the Putter disc for very close range. Discs are 21cm diameter.

16141



ELSON PORTABLE VOLLEY DELUXE

Portable kit used by the USA GOLD MEDAL WINNING BEACH VOLLEYBALL OLYMPIC TEAM. Kit Includes: Poles, Net, Guy Ropes, Boundary Line, Carry Bag & Instructions.

7040	A. Volleyball Kit Elson
7043	Beach Sand Kit - Ropes and Border



**CROSSNET
FOUR SQUARE MEETS VOLLEYBALL**

CROSSNET is the world's first four square volleyball game. Set up within minutes in sand, grass, or indoors.

- Height adjustable for men (2.4m), women (2.2m), and children (1.7m)
- Perfect for backyards, beach days, and BBQs
- All orders come with an official CROSSNET™ four-way net, poles, and volleyball

100215	
--------	--



SPIKEBALL GAME SET

A fun and competitive game that can be played on grass, sand or indoors.

SPIKE001	
----------	--



BOCCE / BOULE

6004	A. Metal
6005	Plastic - Small
6006	B. Plastic - Large

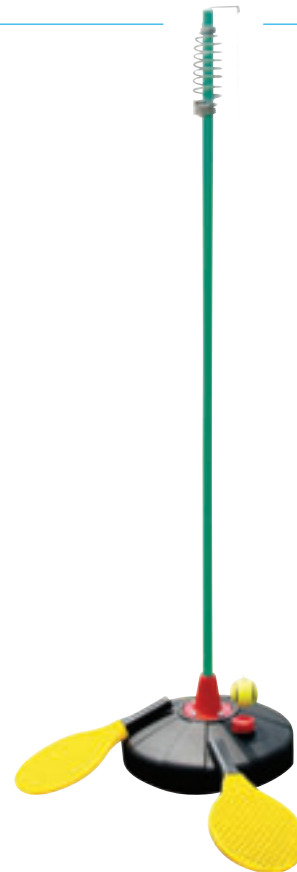

**TOTEM TENNIS - ORBIT
TENNIS - SPIN TENNIS SET**

6044	Spin Tennis Water Filled Base
6045	Replacement Totem Ball
6044SPIKE	Spin Tennis Spike Base (Original)

Please visit www.slatertrellsports.com.au for up to date pricing.

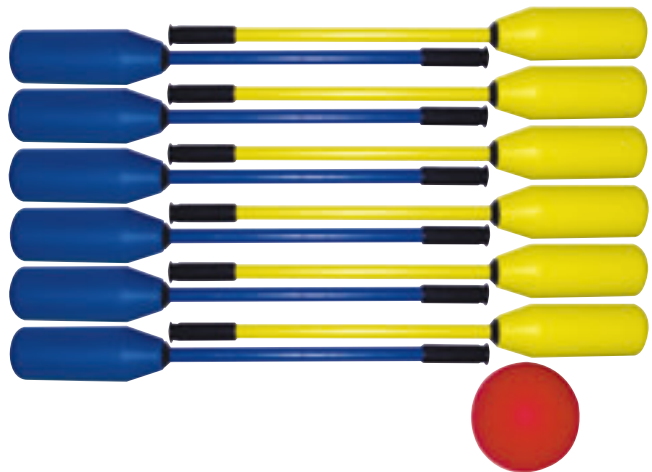

POLO FOAM HOCKEY KIT

33508



POLO FOAM HOCKEY STICK - RED

GAPHS03



POLO FOAM HOCKEY STICK - BLUE

GAPHS04



OUTDOOR PLAY BADMINTON & TENNIS 2 IN 1 SET

With the 2 in 1 Badminton and Tennis Set, you get 2 fun-filled garden games for the price of one.

Featuring an adjustable net that can be at its lowest for tennis or mid-height for badminton, this terrific 2 in 1 outdoor set is a completely versatile set enabling you to play whichever game takes your fancy with straightforward modification of the poles and lawn fixtures.

GAOBTS



OUTDOOR PLAY MULTI RAMP

The Outdoor-Play Multi Ramp is suitable for inline skates, scooters, skateboards and bikes. The total length of ramp is L 113 x D39.5 x H15.5 cm. This item is easy to assemble. The ramps can be used individually without the bridge.

GAOSRM3



CORNILLEAU PRO 510 OUTDOOR TABLE TENNIS TABLE

The curved legs of the Pro 510 Outdoor Table make it the most attractive of outdoor tables. Its design allows it to fit in perfectly in the environment of a campsite, caravan park, resort or hotel. This table is also very popular with schools because of its durability.

100% Weatherproof 7mm Table Top

The table can be used in all circumstances and fears neither blows nor bad weather. Its toughness makes it an all-terrain table, and a 7mm playing top allows for a great game and the perfect bounce.

Fixed Steel Net and Steel Base

This table is designed to be fixed to the ground and comes equipped with adjustable screw fittings. It can be installed in public places without risk of theft as the table can be bolted in place using anti-tamper bolts making its permanent leg assembly unable to be removed.

Corner Protection

Protection on each corner of the table to guarantee maximum safety for children.

Ball Dispensers and Bat Storage

Ball dispensers are conveniently within reach of the player, so you are not chasing balls. You can also store 4 bats on either side of the table.

Made in France with 10 Year Warranty

This table is designed, developed and manufactured in France and backed by the best warranty on the market. All outdoor Cornilleau tables are backed by a 10 year warranty that covers all components with the exception of wearing parts such as wheels, the net and net posts. To make sure you continue enjoying your table long after your guarantee period, Cornilleau promise that spare parts will be available to you for 20 years.

Table Assembly

The table comes flat packed and requires full assembly - a YouTube Assembly video "TAB" is attached to this page.

CORNPRO510



CORNILLEAU SOFTBAT OUTDOOR TABLE TENNIS BAT

The world's first eco-design outdoor racket is made from recycling and recovering cotton / polyester fabrics from former ARMOR LUX collections and end of life clothing picked up from a variety of our clients. The SOFTBAT is the first eco-design outdoor racket on the market!

This is an excellent bat for schools. You can throw anything at this bat as it is almost indestructible, which is why it has become so popular with schools & institutions alike. We highly recommend this bat to all recreational players and think it's a steal for the price.

The Perfect Grip

Elastomer that grips and an upper surface that protects, perfect for positioning of the hand. The round ergonomic handle with soft touch grip is comfortable to use and suits youngsters and adults alike.

Playing Surface and Covering

Non-detachable covering is completely resistant to humidity and will not peel. The playing surface SOFTSKIN creates a good amount of spin for your play.

Unlike indoor bats when left outside, outdoor bats are ultra-durable and last for years and years.

CORNBAT1



RUBBER QUOITS 17CM SET OF 4

Experience a burst of vibrant outdoor excitement with Rubber Quoits, a traditional throwing game that guarantees hours of fun. This exhilarating set features four multi-colored hoops, crafted from durable rubber for maximum resilience, ensuring endless entertainment for everyone.

GARQS4



RUBBER QUOITS

Easy to play for children. Heavy rubber base for stability with a 400mm high stake. Includes six 18cm rubber quoits and supplied with a handy mesh carry bag.

16121



RUBBER HORSESHOE SET

Made from durable weighted rubber, this set includes four horse shoes and two poles. The poles are mounted to a black rubber disc making this set ideal to use indoors or outdoors.

16117



ALPHA GOL ALUMINIUM FOLDING GOAL

The ALPHA GOL Aluminium Goal sits above the pack for portable soccer goals. Constructed with heavy duty aluminium tubing and joints allows the ALPHA GOL to be light weight and durable to withstand heavy use, day in and day out! The ALPHA GOL folds flat for easy storage or portability and will set up in less than 10 seconds. The new and improved 600D elastic wrap around net provides long term durability and will withstand the most powerful shot.

ALPHA GOL has Supplied many of the A-League Clubs, NPL and Academies with these high quality goals.

ALPHA425	4 Foot Wide x 2.5 Foot High	Per End
ALPHA53	5 Foot Wide x 3 Foot High	Per End
ALPHA54	6 Foot Wide x 4 Foot High	Per End



QUICKSTER® SOCCER GOAL 6' X 4'

Get your practice going in under 2 minutes. The Quickster® is easy to setup and ultra-portable, yet durable and stable for youth and elite players alike. The unique Tension-Tite poles create a sturdy frame, while the easy velcro net attachments and steel ground stakes ensure the net will stay put. Carry bag is included for easy, compact storage.

Quickster® Soccer Goal 6x4 Features

- Ultra-durable design for high-intensity training
- Equipped with strong 2-ply netting, heavy gauge tarpaulin facing and easy connection click-lock tubing
- Utilizes Tension-Tite™ Frame Technology
- Lightweight and portable for quick and easy setup

3295OSS



QUICKSTER® SOCCER GOAL 8' X 5'

Get your practice going in under 2 minutes. The Quickster® is easy to setup and ultra-portable, yet durable and stable for youth and elite players alike. The unique Tension-Tite poles create a sturdy frame, while the easy velcro net attachments and steel ground stakes ensure the net will stay put. Carry bag is included for easy, compact storage.

Quickster® Soccer Goal 8x5 Features

- Ultra-durable design for high-intensity training
- Equipped with strong 2-ply netting, heavy gauge tarpaulin facing and easy connection click-lock tubing
- Utilizes Tension-Tite™ Frame Technology
- Lightweight and portable for quick and easy setup

QUICK8X5

Each



QUICKSTER® SOCCER GOAL 12' X 6'

Unlike other training goals, the Quickster 12x6 offers a more authentic visual. Built to stand up to the most powerful shots, the goal combines an authentic white net, crossbar and posts with an easy set up and lightweight design, giving you the look and feel of an authentic goal without the weight and hassle.

Quickster® Soccer Goal 12x6 Features

- Portable goal built to withstand powerful shots
- Works on turf and grass
- Authentic goal look with white net, cross bar and posts
- Fast and easy set up and break down with carry bag

QUICK12X6

Each



BOWNET® PORTABLE GOAL 5M X 2M

Features

- Goal measures at 5M x 2M and is USYS recommended goal size for Youth Soccer
- Bownet's EAST™ technology (Energy Absorption System™) diffuses ball energy throughout the goal to extend its lifespan, give more stability and balance, and add flexibility upon impact
- BOW™ poles and powder coated telescoping frame constructed to distribute goal weight across the bottom base. Kick back feet prevent tipping in all conditions.
- Goal sets up in 135 seconds without the use of tools, guide wires, or heavy steel crossbars giving you a quick set up, take down time, and reducing risk of injury during game and practice
- Includes goal netting, powder coated steel frame, composite BOW™ poles, stakes, and roller case for easy portability and storage.

POR5X2

Each



BOWNET® PORTABLE GOAL 3M X 2M FFA APPROVED

The official size for 8 to 9 year old's - SSG (Small Sided Games) - the SUMMIT FFA Futsal goal has been designed and engineered by Bownet to be the starting point for any club or player to get into the 'Best portable goals in the world'. Faster, better, stronger - you will get playing sooner and feel reassured in the knowledge that your products are supported by the local SUMMIT team. Includes: Soft feel nylon net, powder coated steel frame, pegs and carry bag.

Specs:

- SSG size 2x3m Futsal
- 'Click' locking mechanism for speed and easy set up/take down
- Bownet EAST™ for strength and flexibility
- Local parts and technical support
- Sets up in 120 seconds

BOWNET2X3OSS

Each



ALPHA GOL MATCH

The Strongest and Most Durable Portable Goal Available.

The newly designed ALPHA GOL Aluminium Match Goal is a goal unlike no other. Made entirely out of aluminium and fitted with high density rubber pads, this goal will withstand any training or match environment, indoor or out!

The ALPHA GOL Aluminium Match Goal is a completely rigid frame giving you a professional set up with strength that will allow the ball to hit the post and cross bar like a fixed goal.

The ALPHA GOL comes in 2 carry bags to distribute the weight of the goal, allowing the transportation to and from the field to be as easy as possible. For those with storage the goal can easily fold in at the rear, allowing the goal to be stored flat taking up as little as 20cm in depth.

With each Aluminium Pipe connected via cord, setting up the goal is simple. You can go from bags to play in less than 5 minutes.

Comes with a match quality 3mm net and ground spikes.

ALPHAGOL3X2OSS	3m x 2m	Each
ALPHAGOL5X2OSS	5m x 2m	Each
ALPHAGOLFULLSIZE	7.3m x 2.4m	Each



ALPHA GOL FLEX GOAL

The ALPHA Gear Flex Goal is a rapid set up portable goal that can handle any training session. Designed with a durable, one piece metal base connected with elastic cord and hi quality flex fibre rods that hold and retain the goal shape and quality.

Set up in less than 2 minutes, and pack away even faster!

Can be used on turf or hard floors with sand bags

Features:

- Durable Carry Bag for Storage and Transport
- Great for Small Sided Games, Training Session or Backyard
- 4 U Shape Grass Steaks Provided

ALPHAFLEX18	1.8m x 1.2m	Each
ALPHAFLEX50	5m x 2m	Each



ALPHA GOL FLEX ELITE

The all new ALPHA GOL Flex Elite joins the Portable Elite Goal Range. Sets up in minutes and is ideal for all skill levels and age groups – from youth to senior training or match – for indoor use or outdoor on grass or artificial. The weighted base makes the ALPHA GOL Flex Elite ideal for all surfaces.

FEATURES

- Available in 2m x 1m / 3m x 2m FUTSAL / 5m x 2m / Full Size 7.3 x 2.4
- Durable Bungee Connected Base
- Rubber Feet added for Stability and Floor Protection for Indoor Use
- Heavy Duty Net with Base Wrap
- Box Net Set Up
- Heavy Duty Fibreglass Rods
- Carry Bag Included

ALPHAFLEXELITE1	Full Size 7.3 x 2.4
ALPHAFLEXELITE2	5m x 2m
ALPHAFLEXELITE3	3m x 2m FUTSAL
ALPHAFLEXELITE4	2m x 1m



OUTDOOR PLAY TARGET SHOT SOCCER GOAL

Target shot for practicing precision goal scoring
 New structure style goal with excellent stability and design through joints
 Pole size: 53mm
 Can be used as Target Shot or just as a Soccer Goal
 Goal size: L180 x H130 x D96cm (6ft)
 Retail box packaged

SOGNST6	Each
---------	-------------



PRO SOCCER GOALS

PROOSS1	Full Size
PROOSS2	5m x 2m
PROOSS3	3m x 2m FUTSAL



PRO SOCCER GOAL WHEEL SET OF 4

PROOSSWHEELS	Set of 4 Wheels
--------------	------------------------



**OUTDOOR PLAY
SOCCER GOAL PRO DELUXE**

- Professional style goal with rectangular shaped top
- Joints made from high impact resistant ABS
- Pole size: 68mm
- Includes blue carry bag
- White box with sticker packaged

OPSG01	6 Foot Goal	Each
OPSG02	8 Foot Goal	Each
OPSG03	10 Foot Goal	Each
SOGPD12	12 Foot Goal	Each

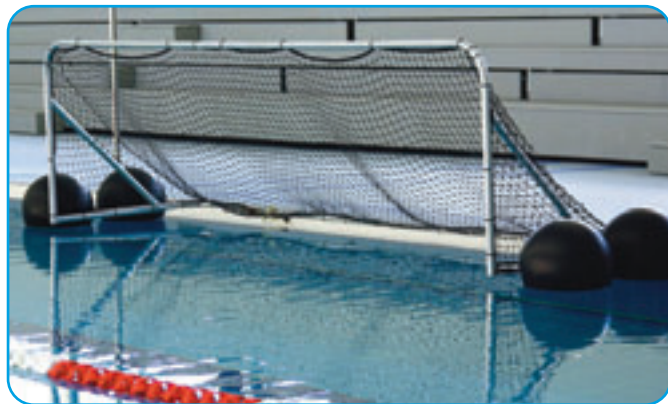

WATER POLO GOALS

4550	Water Polo Goals 1800 x 900mm	Pair
------	-------------------------------	------



SG POP UP GOAL - 6 FOOT

4521		Pair
------	--	------



ALUMINIUM FOLD UP GOALS

4530	1800 x 1200 x 700mm	Pair
4531	2400 x 1800 x 1000mm	Pair
4532	3000 x 2000 x 1000mm Handball	Pair

REPLACEMENT NETS

4530N	1800 x 1200 x 700mm Replacement Net
4531N	2400 x 1800 x 1000mm Replacement Net
4532N	3000 x 2000 x 1000mm Replacement Net



SKLZ PLAYMAKER SOCCER GOAL SET

Two instant pop open goals for pickup soccer games, or shooting and passing exercises. Both goals have attached ground spikes and fit in one easy-carry bag.

The portable SKLZ Playmaker Soccer Goal Set is ideal for pick-up games and practice with younger soccer stars. For older players, the goal set can be used as target or goal for both practice and friendly matches. Easy twist close design for quick breakdown and storage make these nets ideal for taking with you to practice or a park. Measuring 2.5 feet across when assembled, the nets fold down to a compact size for storage and transport. This pair of durable goals feature attached spikes that securely anchor into the ground and a carrying case so you and your friends can truly start a match wherever you go.

Two durable soccer goals for pickup games or practice drills
 Instant pop open design and attached ground stakes for easy setup
 Easy twist close design and carry bag for quick breakdown and storage
 Lightweight, portable and easy to carry
 Each goal measures 2.5 feet"

3425OSS



SKLZ PLAYMAKER SOCCER GOAL SET

The durable Precision Pop-Up Goal opens in an instant to create a goal on one side and a shooting and passing target on the other. With attached ground stakes that hold it firm to the grass, the goal is perfect for pickup games or mastering passing and shooting technique.

True to its name, the durable two-sided Precision Pop-Up Goal opens in an instant to create a goal on one side and a training target on the other. With attached ground stakes that hold it firm to the grass, the goal stands up to the hardest shots and is perfect for pickup games. Switch to its target side and practice as a team or on your own to build coordination, timing, and technique. The Precision Pop-Up Goal comes with a convenient carry bag and features an easy twist-open frame design so you can quickly set up for a game or training session anywhere. Available in 3', and 4' designs, the Precision Pop-Up Goal gives players of any age or skill level the pickup games and maximum training reps they need. Build the muscle memory, endurance, and ball control needed to improve passing and shooting. The versatile goal is perfect for solo or team training.

- Durable soccer goal and precision target for pickup games or practice drills
- Two-sided design allows players to easily switch from precision target to goal
- Instant pop open design and attached ground stakes for easy setup
- Easy twist-close design for quick breakdown and storage
- Lightweight and portable, carry bag included
- * 4 x 3 feet

235854OSS

4x3 Feet

235853OSS

3x2 Feet



PUGG GOAL - 6 FOOT

Pugg Goals are the ideal time saver during fielding practice placed behind the fielding stump, all but the wildest of throws will be caught in the large net. Comes in a carry bag and is lightweight, easy to assemble. As used by international teams and coaches.

Size: 6ft w x 3.5ft h x 3.5ft d

4520

Pair



PVC GARDEN GOAL

4545 2400 x 1200 x 1000mm

Pair

4546 3660 x 1830 x 1000mm

Pair



ALPHA GEAR SQUARE POP UP – PAIR

This range of ALPHA GEAR Pop Up Goals are ideal for all levels of play and training. The simple one piece twist and pop up design ensures you're playing in seconds, and pack away is just as quick! ALPHA GEAR has redesigned the pop up goal to ensure that it performs day in and day out! The ground stakes are new and improved Poly Carbonate material that ensures they never snap. For those really tough fields you are given metal grass anchors. Coupled with the durable corner joints, reinforced stitching and hi quality fibre rods makes the ALPHA GEAR Pop up the ideal training partner! Features

PAIR (2 in one carry bag) of Portable Goals
 Easy One Piece Design for Set Up and Pack Away in Seconds
 New and Improved Unbreakable Ground Stakes

APUG5SQ	5 Foot
APUG4SQ	4 Foot



ALPHA GEAR ROUND POP UP – PAIR

The Round Pop Up Goal by ALPHA GEAR is ideal for all levels of play and training. The simple one piece twist and pop up design ensures you're playing in seconds, and pack away is just as quick! ALPHA GEAR has redesigned the pop up goal to ensure that it performs day in and day out! The ground stakes are new and improved Poly Carbonate material that ensures they never snap. For those really tough fields you are given metal grass anchors. Coupled with the durable corner joints, reinforced stitching and hi quality fibre rods makes the ALPHA GEAR Pop up the ideal training partner!

PAIR (2 in one carry bag) of Portable Goals
 Easy One Piece Design for Set Up and Pack Away in Seconds
 New and Improved Unbreakable Ground Stakes

APU6	6 Foot
APU4	4 Foot
APU25	2.5 Foot



SG RECTANGULAR POP UP GOALS

- Frame made from 100% fibre rods
- Polyester mesh net fabric with classic goal design & pop up feature
- Folds flat to pack away
- Includes nylon carry bag

Sizes Available:

SMALL (S) – 120cm (48”), (W: 120cm x D: 106 x H: 105cm) - ORANGE
 MEDIUM (M) – 150cm (60”), (W: 150cm x D: 108cm x H: 116cm) - RED
 LARGE (L) – 180cm (72”) and (W: 180cm x D: 120cm x H: 130cm) - BLACK

4521S	Small	Pair
4521M	Medium	Pair
4521L	Large	Pair



PORTABLE FULL SIZE ALUMINIUM SOCCER GOALS

Features

- Senior Size: 7.32mtrs x 2.44mtrs
- 88.9mm diameter Structural Grade DNV Certified 6082 Aluminium main cross bar, up rights and rear bottom frame.
- Side braces 50mm x 5.35mm
- Demountable four-piece frame construction with eight base anchor plates welded to frame.
- Cross bars attach to end frames with Tamper Proof Bolts, drivers are included for assembly.
- Ground anchor pegs supplied.
- Two removable solid wheels per goal.
- Powder coated; Pearl White.
- Goals delivered to site in metro Area
- Soccer goal nets will be included with each pair.

PSG01	Pair
-------	-------------

Please visit www.slatertrellsports.com.au for up to date pricing.

CUSTOM TEAMWEAR

**YOUR TEAM OR CLUB CAN NOW
LOOK LIKE TRUE PROFESSIONALS.**

Slater-Gartrell Sports clothing range offers a combination of high performance fabrics in conjunction with a comfortable and functional fit to meet a player's match and training kit requirements at every level.

Slater-Gartrell Sports understands the needs of teams and our range of high performance stock match shirts, training wear and leisure garments combined with an extensive range of customised options cater for every scenario.

Our specialised design team can assist and advise on every aspect of incorporating your specific school, club or university colours onto any garment.

Our embroidery and printing facilities allow quick turnaround on stock items which can all be embellished with your club logo, numbers and or sponsor logo.



**SLATER-GARTRELL
SPORTS**

FUTURE STAR JWS JUNIOR - GOLF PACKAGE SETS

The new PGF Future Star JWS range is the ideal way for kids to get started in the game of golf. There is a size and specification for all ages with 3 different sizes for 3 different age groups plus a girls spec for 9+'s . PGF Future Star clubs are made with lightweight Junior Weight Specific (JWS) components that are easy to swing with oversize heads that are super easy to hit and launch the ball high. *Hybrid, #9 iron and Sand Wedge also available to upgrade your set.

Future Star Base package includes*:

- Oversize driver with headcover
- #7 iron + heel-toe putter
- Ultra forgiving oversize heads:
- Lightweight stand bag with hood and dual shoulder strap for easy carrying
- Lightweight, flexible shafts to launch the ball high and long
- Junior size soft wrap grips for kid's hand sizes

FS5PC	FS JWS 5pc Golf Set
FS6PC9	FS JWS 6pc Golf Set (With #9 Iron)
FS6PCSW	FS JWS 6pc Golf Set (With Sand Wedge Iron)
FS6PCH	FS JWS 6pc Golf Set (With Hybrid)
FS7PC9S	FS JWS 7pc Golf Set (With #9 & Sand Wedge Irons)
FS7PCH9	FS JWS 7pc Golf Set (With Hybrid & #9 Iron)
FS7PCHS	FS JWS 7pc Golf Set (With Hybrid & Sand Wedge Iron)
FS8PC	FS JWS 8pc Golf Set

*Also available Hybrid, #9 Iron and Sand Wedge to upgrade or for separate purchase.



GREEN - Age 3-5 Years



RED - Age 6-8 Years



BLUE - Age 9-12 Years



PINK - Age 9-12 Years



DRIVER JUNIOR

FSDRIVER



HYBRID JUNIOR

FSHYBRID



PUTTER JUNIOR

FSPUTTER



BAGS JUNIOR

FSBAG	Blue Bag
FSBAGP	Pink Bag



IRONS JUNIOR

FSI7	#7 Iron
FSI9	#9 Iron
FSISW	Sand Wedge Iron

Please visit www.slatertrellsports.com.au for up to date pricing.



OPTIMA POP-UP CHIPPING NET

OP03



OPTIMA AIR FLOW PRACTICE BALLS

OP04 12 Pack



OPTIMA TRUE FLIGHT FOAM PRACTICE BALLS

OP05 12 Pack



OPTIMA PUTTING CUP RUBBER

OP06



OPTIMA PUTTING MAT WITH BALL RETURN

OP07 7 FT



OPTIMA DUAL TURF DRIVING MAT

OP08



OPTIMA WHITE HPX GOLF BALLS

OP09

Dozen



OPTIMA PREMIUM GOLF TEES WHITE

OP10

125PK



FRISBEE GOLF BASKET

Very popular worldwide game suitable for all ages. Portable target is 132cm high and 60cm diameter. The twelve pieces of chain allow the frisbee discs to drop in to the basket. Includes 4 metal stakes to secure to ground.

16140



GOLF CHIPPING BASKET

- Used to practice the accuracy of your gold chip shots
- Heavy duty steel tube ring and frame
- Fine netting to contain balls

100116



FRISBEE GOLF DISC SET

Set of 3 Frisbee discs designed especially for Frisbee Golf. The Driver disc is designed for long range shots off the tee. Use the Mid-range disc for more accurate shots at the target and the Putter disc for very close range. Discs are 21cm diameter.

16141



GOLF BALLS

OP09	Optimax HPX - Dozen
4730	SG School - Dozen
4731	Deluxe - Dozen
4732	Secondhand - Dozen



GOLF BUGGY

30111	Racer Buggy
-------	-------------



GOLF BAG

4700	Golf Bag
------	----------



SENIOR GOLF CLUBS

4710	Irons 3 to 9 PW & SW	Each
4711	Putters	Each
4712	Metal Woods 1 to 5	Each



DIVOT TOOLS

4790	
------	--



RUBBER HIT OFF MAT

4791	
------	--



BALL MARKERS

4793		24 Pack
------	--	---------

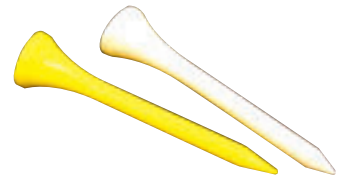

GOLF TEES WOODEN

4794	Wooden Tees	15 Pack
4795	Wooden Tees	1000 Pack



GO-GO GOLF BALLS YELLOW

4760		Each
------	--	------



GO-GO GOLF TEE YELLOW

4761		Each
------	--	------



O-BALLS PUTTING ALIGNMENT TRAINER

OP11	
------	--



SMALL BLOCK

33460 (230 x 480 x 240mm)



LARGE BLOCK

33458 (910 x 480 x 240mm)



SMALL CYLINDER

33467 (465 x 235mm)



LARGE CYLINDER

33465 (900 x 405mm)



TWO STEPS

33486 (465 x 505 x 475mm)



THREE STEPS

33485 (605 x 755 x 605mm)



SMALL WEDGE

33476 (905 x 450 x 300mm)

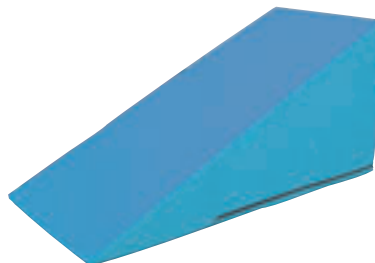

MEDIUM WEDGE

33475 (1200 x 600 x 600mm)

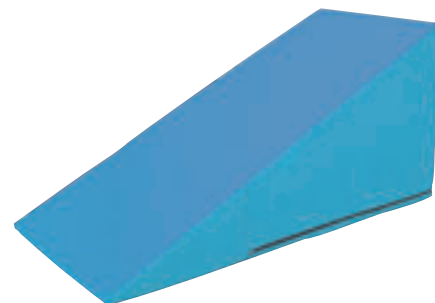

LARGE WEDGE

33477 (1800 x 400 x 900mm)



STEP FOR WAVE

33456 Steps for Wave includes velcro
Note: Bulky Freight Item

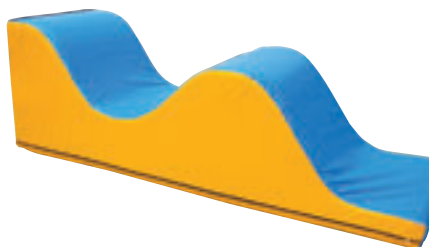

WAVE

33455 (1800 x 600 x 600mm)
Note: Bulky Freight Item



BALANCE TRAINER BEAM

This product provides children with an excellent way to improve their balance. It is made from a high density foam that weighs 8kg. The extra wide base measures 450mm and is 1200mm long. The top measures 150mm where the kids walk.

33490 Note: Bulky Freight Item



GYM MATS

- 4900 Heavy Duty Velcro Ends 1800 x 1200 x 50mm
- 4901 Heavy Duty Velcro Ends 1800 x 900 x 50mm
- 4900S Heavy Duty 1800 x 1200 x 50mm
- 4901S Heavy Duty 1800 x 900 x 50mm



GYM MAT - 3 PIECE

- High density nylon material
- Folds into 3 sections for easy storage
- comes with handle for convenient transportation
- Size: 1800mm x 900mm x 50mm (unfolded)
- Size: 600mm x 600mm x 160mm (folded)

3PCEGM



GYM MAT TROLLEY

4920



PERSONAL MATS

- 4910 Deluxe 1200 x 600mm
- 4911 Standard 900 x 600mm



PERSONAL GYM MAT 3 PIECE

- 3 Piece Gym Mat folds into 3 sections for easy storage
- High density nylon material
- Comes with handle for convenient transportation
- Size: 1800mm x 600mm x 50mm (unfolded)
- Size: 600mm x 600mm x 160mm (folded)

3PCEGM



RINGMASTER PILATES MAT BLUE

- Eco friendly, non toxic, soft touch and anti slip
- Widley used in pilates, yoga and gymnastics
- Excellent support for hands, feet and spine
- Materials: NBR (Nitrile Rubber)
- Colour: Blue
- Size Available: 178cm x 60cm x 1.5cm

30112



CHALK BLOCKS

4930 Magnesium Carbonate 440g (8 x 55g Blocks)



SELECT LIGHT GRIPPY

50010 Size: 0
50011 Size: 1



SELECT MUNDO TEAL

5002 Size: 2



SELECT MUNDO PURPLE

5003 Size: 3



SELECT SOLERA YELLOW

5005 Size: 2



SELECT SOLERA PINK

5004 Size: 3



MOLTEN SYN/LEATHER

5006 Size: 3



RINGMASTER RUBBER

5007 Size: 3



LIGHT GRIPPY BALL PACK

Pack Includes:
10 x Light Grippy Balls,
Pro Ball Bag and Valve Oil

50012 Size: 1
50013 Size: 0



MUNDO GREEN BALL PACK

Pack Includes:
10 x Mundo Teal Balls,
Pro Ball Bag and Valve Oil

50014 Size: 2
500143 Size: 3

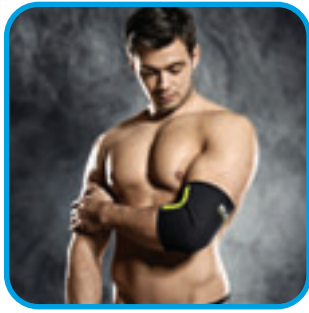

PADDED ELBOW PADS SELECT

SEPXS	XS	Each
SEPS	Small	Each
SEPM	Medium	Each
SEPL	Large	Each



PRO ELBOW PAD SELECT

SPEPXS	XS	Each
SPEPS	Small	Each
SPEPM	Medium	Each
SPEPL	Large	Each



HANDBALL RESIN

Resin with strong adhesive effect. Used at absolute top level.
Approved by the International Handball Federation (IHF).

5020	100ml
50205	500ml



PADDED KNEE PADS SELECT

SPNXS	XS	Pair
SPNS	Small	Pair
SPNM	Medium	Pair
SPNL	Large	Pair



PRO KNEE PAD SELECT

SPKPXS	XS	Each
SPKPS	Small	Each
SPKPM	Medium	Each
SPKPL	Large	Each



HANDBALL RESIN REMOVER

Effective removal of all types of resin.
Gentle on the hands. Creamy consistency.

5021	500ml
------	-------



KNEE SUPPORT SPLINT

KSS01	XS-Small	Each
KSS02	Medium-Large	Each
KSS03	XL-XXL	Each



WRIST SUPPORT

WS01	XS-Small	Each
WS02	Medium-Large	Each
WS03	XL-XXL	Each



HANDBALL GOALS

Size: 3000 x 2000 x 1000mm
1450HBG



GARMIN VIVOSMART 4

Smart Activity Tracker with Wrist-based Heart Rate

Accent your style while enhancing your fitness with our vivosmart 4 activity tracker. This slim, swim-friendly wearable comes loaded with fitness and wellness features to help you make the most of a healthier, more active lifestyle. A wrist-based Pulse Ox sensor lets you estimate blood oxygen saturation while you're sleeping — or you can spot-check your oxygen levels anytime during the day. The device also monitors heart rate at the wrist and includes helpful tools such as all-day stress tracking, a relaxation breathing timer and VO2 max readings. Plus, Body Battery energy monitoring helps you know when you're primed to be active or when you may need to rest. Safe for the pool or shower, vivosmart 4 keeps you going strong with up to 7 days of battery life — while smart notifications with vibration alerts help you stay connected on the go (when connected to a compatible smartphone).

8212	Black
------	-------



GARMIN FORERUNNER 45

Easy-to-use GPS Running Watch with Wrist-based Heart Rate

You're a runner, so train like one. Forerunner 45 is a fuss free running watch that monitors heart rate[1] at the wrist and uses GPS to track your pace, distance and more. It works with free Garmin Coach adaptive training plans that bring personal coaching to your wrist. Stay connected when you want to with notifications[2] for texts and calls, and feel secure with safety and tracking features that let you send your real time location to emergency contacts[2]

30113	Iris - 39mm Face
30114	White - 39mm Face
30115	Black - 39mm Face
30116	Black - 45mm Face
30117	Black - 45mm Face



GARMIN FORERUNNER 245

Here's something to sing about: music storage right on your wrist.

- Advanced Performance Analytics
- More Ways to Work Out
- Stay Connected on the Run

30118	White
30119	Grey
30120	Black
30121	Aqua



GARMIN FENIX 6

Multisport GPS Watch for Fitness, Adventure and Style

- Premium multisport GPS watch with Elevate™ wrist heart rate technology
- Fit for adventure with rugged design that features stainless steel bezel, buttons and rear case
- Put key stats at your fingertips with the performance widget that shows the effects and progress of your workouts
- Connected features include smart notifications, automatic uploads to Garmin Connect™ online fitness community and personalization through free watch faces and apps from our Connect IQ™ store
- Outdoor sensors, including GPS and GLONASS satellite reception and 3-axis compass with gyroscope and barometric altimeter
- Battery life: up to 2 weeks in smartwatch mode (depending on settings), up to 24 hours in GPS mode or up to 60 hours in UltraTrac™ battery saver mode

GF6

GARMIN™

HEART RATE MONITOR

Get a quality workout with our heart rate monitor. When worn around your chest during an activity, it wirelessly transmits your heart rate to your compatible device for instant feedback on how hard you're working.

The front part of the strap contains the heart rate module and is made of flexible plastic. The part of the strap that goes around your back is made of a soft fabric and is adjustable to your size.

Use and care of the heart rate monitor is a snap. Once it's paired with your compatible device the first time, it will automatically recognize it each time. The fabric of the strap can be removed and hand-washed as often as needed.



8215 Heart Rate Monitor



GARMIN EDGE 830 GPS BIKE COMPUTER

GPS Bike Computer for Performance and Racing

The Garmin Edge 830 GPS Bike Computer really is at the edge of innovation when it comes to advanced bike computer technology. The best selling Edge 520 has been upgraded and improved across the board. The Edge 830 offers dynamic performance monitoring and insights to help take your bike riding to the next level. The improved processor makes it twice as fast as its predecessor, with an increased battery life of 20 hours and a 13% larger colour touchscreen display. The Edge 830 is packed full of new features to enhance your riding and training, starting with performance focused metrics such as VO2 Max, recovery time, training status/load with new training load focus, Heat/Altitude Acclimation status and smart nutrition/hydration tracking. The new Climbpro feature allows you to see the remaining grade and ascent when climbing, while mountain bikers are well looked after with new Mountain Bike Dynamics tracking your jumps and descents, while Foresight will automatically display upcoming forks in the trail when you pause, to give you at a glance context of where you are in the trail network. These features really are great for mountain biking, making the Edge 830 a real option for both the road and the trails.

30122 Edge 830



HRM-RUN™

The HRM-Run heart rate monitor provides the most advanced running metrics to high-end Garmin Forerunner® running watches. The strap is seamlessly comfortable and easily adjustable while the module is small, lightweight and fits entirely within the width strap.

HRM-Run provides 6 running dynamics metrics:

- Cadence — number of steps per minute
- Vertical oscillation — degree of 'bounce' in your running motion; displays the vertical motion of your torso, measured in centimeters for each step
- Ground contact time — amount of time in each step that you spend on the ground while running; measured in milliseconds
- Ground contact time balance — displays the left/right balance of your ground contact time while running (displays a percentage); for example, 53.2 with an arrow pointing left or right
- Stride length — length of your stride from 1 footfall to the next; measured in meters
- Vertical ratio — ratio of vertical oscillation to stride length (displays a percentage); a lower number typically indicates better running form

This real-time data can help athletes take their performance to the next level by showing them where they can improve their running form.

30123 HRM-Run

OTHER MODELS ARE AVAILABLE. PLEASE CALL (08) 9274 5788



CURVED LARGE BUMP PAD

- 5101R Red
- 5101B Royal Blue



STRAIGHT LARGE BUMP PAD

- 5106R Red
- 5106B Royal Blue
- 5106N Navy
- 5106Y Yellow



STRAIGHT XL BUMP PAD

- XLBPR Red
- XLBPB Royal Blue
- XLBPN Navy
- XLBPY Yellow



CURVED BUMP PAD

- 5105R Red
- 5105B Royal Blue
- 5105N Navy
- 5105Y Yellow



RUCK BAG XL

- 5108C Royal Blue



MOBILE RUCK BAG WITH LEDGE

- 5109R Red
- 5109B Royal Blue
- 5109N Navy



RUCK BAG WITH HANDLES

- RBWHR Red
- RBWHB Royal Blue



SQUARE BUMP PAD LARGE

- 5107R Red
- 5107B Royal Blue
- 5107N Navy
- 5107Y Yellow



FOREARM CURVED BUMP PAD

- 5100R Red
- 5100B Royal Blue
- 5100N Navy



CONVEX BUMP PAD

- | | |
|-------|------------|
| 5104R | Red |
| 5104B | Royal Blue |
| 5104N | Navy |



CONCAVE BUMP PAD

- | | |
|-------|------------|
| 5102R | Red |
| 5102B | Royal Blue |
| 5102N | Navy |



DIAMOND PROTECTIVE SHIELD

- | | |
|-------|------------|
| 5103R | Red |
| 5103B | Royal Blue |
| 5103N | Navy |



MEDIUM TACKLING BAG

- Heavy duty vinyl cover
- High density foam core
- Reinforced suede handles

- | | |
|-------|-----------------------------|
| 5112R | Red - 1200mm x 350mm |
| 5112B | Royal Blue - 1200mm x 350mm |
| 5112N | Navy - 1200mm x 350mm |
| 5112Y | Yellow - 1200mm x 350mm |



LARGE TACKLING BAG

- Heavy duty vinyl cover
- High density foam core
- Reinforced suede handles

- | | |
|-------|-----------------------------|
| 5111R | Red - 1500mm x 400mm |
| 5111B | Royal Blue - 1500mm x 400mm |
| 5111N | Navy - 1500mm x 400mm |
| 5111Y | Yellow - 1500mm x 400mm |



EXTRA LARGE TACKLING BAG

- Heavy duty vinyl cover
- High density foam core
- Reinforced suede handles

- | | |
|-------|-----------------------------|
| 5110R | Red - 1800mm x 450mm |
| 5110B | Royal Blue - 1800mm x 450mm |
| 5110N | Navy - 1800mm x 450mm |
| 5110Y | Yellow - 1800mm x 450mm |



SG DIMPLE HOCKEY BALL

5200



SG SEAMLESS HOCKEY BALL

5201



GRYPHON DIMPLED CLASSIC HOCKEY BALL

- 30124 White
- 30125 Yellow
- 30126 Pink
- 30127 Orange



GRYPHON MINKEY BALL

- 30128 Blue
- 30129 Pink
- 30130 Yellow
- 30131 Rainbow



MINKY POLY JUNIOR 4.5 OUNCE

5206 Minky Poly Junior



KOOKABURRA ELITE DIMPLE

5203 Dimple Standard White



KOOKABURRA DIMPLE VISION PINK

5203P Dimple Vision Pink



KOOKABURRA DIMPLE VISION WHITE

5204 Dimple Vision White



KOOKABURRA SEAMLESS STANDARD

5205 Seamless Standard



KOOKABURRA ELITE DIMPLE

5202 Elite Dimple

ACROMAT

ACROMAT

SLATER-GARTRELL SPORTS WA AGENT

Acromat is now recognised as a world leader in gymnastic and sporting equipment, with the Acromat's performance finely tuned to match the high expectations of athletes at all levels of competition. To ensure the needs of gymnasts and athletes are met, especially in the critical areas of engineering strength and safety, we design much of our equipment in close consultation with leading coaches.

Please forward all enquiries to: sales@slatertrellsports.com.au



MINKY SPECIAL 30"

520730 Minky Special 30"



MINKY SPECIAL 33"

520733 Minky Special 33"



MINKY SPECIAL 34"

520734 Minky Special 34"



FULL SIZE SPECIAL 36"

5208 Full Size Special 36"



**KOOKABURRA/
GRYPHON SPECIALS FULL
SIZE**

5209 Kookaburra/Gryphon Specials



**GRYPHON GATOR
JUNIOR STICK BLACK**

- 30204 Black 26"
- 30205 Black 28"
- 30206 Black 30"
- 30207 Black 32"
- 30208 Black 34"



**GRYPHON GATOR
JUNIOR STICK PINK**

- 30133 Pink 26"
- 30134 Pink 28"
- 30135 Pink 30"
- 30136 Pink 32"
- 30137 Pink 34"



**GRYPHON FLOW
SENIOR STICK BLACK**

30138 Black 36.5"



**GRYPHON FLOW
SENIOR STICK TEAL**

30139 Teal 36.5"



OBO HELMET WITH CAGE - DELUXE

5230



THROAT PROTECTOR

5231



GRYPHON PADDED SHORTS

5232 Small

5232M Medium

5232L Large



GRYPHON BODY SUIT CHEST, SHOULDERS & ARMS

5233 Small

5233M Medium

5233L Large



GRYPHON FAT TONY GOAL KEEPER BAG BLACK

5272

\$139.00



GRYPHON S2 LEG GUARDS BLACK

5239 Medium

5239L Large



GRYPHON S2 KICKERS

5237 Medium

5237L Large



GRYPHON S2 HAND PROTECTOR ONE SIZE

5238 One Size

SG KICKERS, LEG GUARDS AND GLOVES

5242 SG Leg Guards

5243 SG Kickers

5244 SG Gloves

JUNIOR SERIES

5260 Gryphon Junior Foam Series - Pads & Kicker Combo

5261 Gryphon junior foam series - gloves

HOCKEY PROTECTIVE KIT EVO STANDARD

Includes: Leg Guards, Kickers, Hand Protectors, Padded Shorts, Upper Body Suit, OBO Helmet, Throat Protector, Smock & Tour Bag.

5262



SMOCK

5270 A. Smock



NYLON GEAR BAG

2772 Nylon Gear Bag

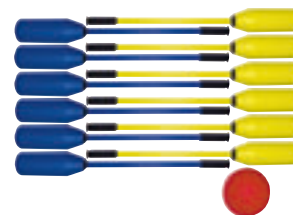

POLO HOCKEY KIT

33508



STREET HOCKEY STICK

5280 Plastic handle plastic blade snr



GOAL KEEPER STICK

5281 Goal Keeper Stick

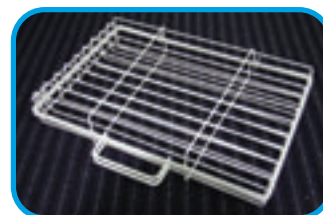

BALL CAGE

5221 Ball Cage Holds 24 Balls

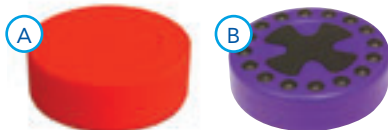

PUCKS FOR STREET & UNDER WATER HOCKEY

5290 A. Standard

5291 B. Deluxe with Rollers

5293 Under Water Hockey Puck



SUPER CUP PATRICK

6277XS Size: XS - Colour: Black

6277S Size: Small - Colour Black

6277M Size: Medium - Colour: Black

6277L Size: Large - Colour: Black

6277XSW Size: XS - Colour: White

6277SW Size: Small - Colour White

6277MW Size: Medium - Colour: White

6277LW Size: Large - Colour: White



STANDARD SELECT

- Front: Hot Stamp Foiling
- Backing: Plain EVA
- Packing: OPP Bag

6293XS XS

6293S Small

6293M Medium

6293L Large

SHIN GUARDS



CLUB PRO SELECT

- Front: Printed PPCP shell
- Backing: EVA Laminated with Polyester Fabric
- Closure: Top back closure
- Ankle sock: Stitched ankle sock
- Packaging: OPP Bag

6290XS XS

6290S Small

6290M Medium

6290L Large



PATRICK ATOMIC

6279XS Size: XS - Colour: White

6279S Size: Small - Colour: White

6279M Size: Medium - Colour: White

6279L Size: Large - Colour: White

6279XSK Size: XS - Colour: Black

6279SK Size: Small - Colour: Black

6279MK Size: Medium - Colour: Black

6279LK Size: Large - Colour: Black



FORCE PLUS SELECT

- Front: Printed PPCP shell
- Backing : EVA Laminated with Polyester Fabric
- Closure : Top back closure
- Ankle sock : Printed Detachable ankle sock with Plastic discs

SFPXS XS

SFPS Small

SFPM Medium

SFPL Large

CUSTOM TEAMWEAR

**YOUR TEAM OR CLUB CAN NOW
LOOK LIKE TRUE PROFESSIONALS.**

Slater-Gartrell Sports clothing range offers a combination of high performance fabrics in conjunction with a comfortable and functional fit to meet a player's match and training kit requirements at every level.

Slater-Gartrell Sports understands the needs of teams and our range of high performance stock match shirts, training wear and leisure garments combined with an extensive range of customised options cater for every scenario.

Our specialised design team can assist and advise on every aspect of incorporating your specific school, club or university colours onto any garment.

Our embroidery and printing facilities allow quick turnaround on stock items which can all be embellished with your club logo, numbers and or sponsor logo.



**SLATER-GARTRELL
SPORTS**



**1.1L
SaniDispenser**

- ✓ Automatic, no-touch dispensing
- ✓ Environmentally friendly refillable cartridge
- ✓ Easy to clean and service

**15L
Liquid Sanitiser**

- ✓ Premium pharmaceutical grade (72%)
- ✓ Non-sticky, fast drying formula
- ✓ Kills 99.9% of germs

**Powdercoated
SaniStand**

- ✓ Available in standard white or custom finishes
- ✓ Stylish and sturdy
- ✓ Provides placement flexibility



**1 x stand
1 x dispenser
1 x 15L sanitiser**

SANISTATION BUNDLE

- Includes:
- 1 x stand
 - 1 x dispenser
 - 1 x 15L sanitiser

Stylish and sturdy. Provides placement flexibility.

IDC001

**INSTANT HAND SANITISER
MOISTURISING 500ML**

- Kills 99.99% of germs
- 75% Ethanol

MSHS01



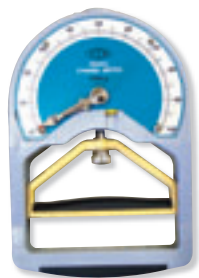

GRIP TESTER

This instrument is used for evaluating the strength of the hand and for arm. It measures a grip strength of up to 100kg and comes complete with a sturdy case and instructions. Advanced Hand Dynamometer • Strength tester • Give accurate grip strength readings • Strong/sturdy frame

5350



PORTABLE DRY SPIROMETER

You can easily demonstrate and measure these differences in your classroom with this accurate, easy-to-use, handheld, dry gas meter. It measures vital capacity, tidal volume, and expiratory reserve volume. Students can then calculate inspiratory reserve volume and inspiratory capacity from these values.

5353 Spirometer - Portable

5366 50 x Replacement Mouthpieces



Trunk Flexibility Tester

all steel construction, comes complete with max reach indicator, footplate, adjustable extension & instructions.

TRUNK TESTER

5357



AUTO INFLATION DIGITAL SPHYGMOMANOMETER

The display also shows the current time and the WHO guideline classification for the blood pressure shown. Automatic inflation system • Blood pressure and pulse rate • 2 memory banks each storing 60 readings (perfect for two people or morning and evening readings). • Clock function Standard adult cuff size 22-32cm. • Body motion indicator. Pulse rhythm indicator. Automatic power off Error indication. • Carrying bag, instruction manual and 4 x AA batteries

PE088



SPHYGMOMANOMETER CLASSROOM SET

The Stethoscope is light weight and adjustable with a highly sensitive chest piece for easy listening. Ideal for basic diagnostic uses Comes with a vinyl storage case.

This aneroid sphygmomanometer, complete with stethoscope, is attached to a hook cuff and is calibrated to 300mm Hg.

Comes complete with vinyl case. Sphygmomanometer gauge has no pinstop, allowing for visual check of calibration. Other features include a cuff clip and nylon cuff with Velcro closure, inflation bulb, and thumbscrew valve.

5351



BEEP TEST CD

5358 20m Shuttle Run Test



OMRON AUTO DIGITAL DELUXE SPHYGMOMANOMETER WITH M-L CUFF

The Deluxe blood pressure monitor also incorporates a 60 reading memory with date and time. Enhanced Intellisense • One Touch Use - Easy one touch operation allows home blood pressure monitoring that is both simple and accurate • 60 Reading Memory - 60 memory storage allows you to review the last 60 readings with a touch of a button • Hypertension Indicator - Alerts you if your blood pressure reading exceeds internationally recognised guidelines for normal home blood pressure levels • Cuff Wrapping Guide - An indicator confirms that the cuff has been wrapped correctly on the user's arm • Body Movement Indicator - Alerts the user if any body movement has occurred during the blood pressure reading

PE261



SPHYGMOMANOMETER MANUAL DIGITAL

5352



HANDY HEIGHT SCALE

Fix the top portion of the unit to a wall 2 metres above the floor, then lower the bottom portion to the student's head and read the measurement. Stature meter.

Fix the top portion of the unit into the wall 2 metres above the floor - screws provided. Pull the meter down onto individuals head & read the measurement.

5355 Handy Height Scale



SKIN FOLD CALIPER STANDARD

The Slim Guide caliper is a good choice for measuring body fat at home or for use in professional settings.

It is made with quality components to ensure it withstands regular use. The Slim Guide Skinfold Caliper meets or exceeds requirements for jaw pressure and accuracy. This body fat tester has a convenient trigger operation with pistol grip handle. Durable accurate and easily used by students. Complete instructions included. An instruction booklet is included for easy use.

Instruction Booklet Included.

5354



PORTABLE HEIGHT SCALE

Portable Height Scale can be carried easily from room to room, or inside a car.

The height scale comes in two parts for ease of transport. Portable height scale is made of sturdy materials and easily disassembled. Simple and easy to set up - no wall fastening necessary.

5356 Height Scale Portable



SWIFT YARDSTICK

Yardstick gets its name from being the standard chosen by countless professionals for measuring jump height. Simple mechanical, and ever ready, no pro operates without one. Now with stronger wheeled carry bag.

5361



SCALES 150KG

Weight Scales & Body Fat Monitor

5365

OTHER PRODUCTS

3225 Heart Foundation Pedometer
Wall Charts



DIGITAL HAND DYNAMOMETER

Utilizing electronic load cell transducers instead of hydraulic fluid mechanisms that are prone to leakage.

The Dynamometer is extremely durable and designed to last for many years. Highly accurate grip strength measurement from 0-200 pounds is digitally displayed on the LCD and up to 20 test results for each hand can be stored in memory.

The built-in battery is long lasting and is easily recharged when connected to a PC using the USB cable included with the Dynamometer.

PE016



OMRON TH839S EAR THERMOMETER

The Omron TH839S digital ear thermometer comes as a saviour to get near-perfect body temperatures without causing any discomfort to your baby.

It displays the body temperature within seconds using its one second quick measurement technique. This ear thermometer has an ergonomic design that helps easy handling. Its advanced infrared and ambient temperature compensation technology helps take accurate temperature readings quickly and easily.

The infrared probe is one of the main and delicate parts of the thermometer. Position it into the ear canal and it measures the temperature of the tympanum and displays the reading on the display window. The probe must always be used along with the probe cover.

PE273

YO YO BEEP TESTS

The Yo Yo Beep Test is a useful and valid tool for obtaining important information about the fitness status of an athlete. This test can be used with both untrained and trained athletes.

PE074



TRAINING SINGLET
SG PRO

Airflow mesh material for superior cool comfort. Reinforced seams for durability.

2004XSY	XS Yellow
2004XSB	XS Royal Blue
2004XSR	XS Red
2004XSW	XS White
2004XSBG	XS Bright Green
2004XSBO	XS Bright Orange
2004XSK	XS Black
2004XSP	XS Pink
2004SY	Small Yellow
2004SB	Small Royal Blue
2004SR	Small Red
2004SW	Small White
2004SBG	Small Bright Green
2004SBO	Small Bright Orange
2004SK	Small Black
2004SP	Small Pink
2004MY	Medium Yellow
2004MB	Medium Royal Blue
2004MR	Medium Red
2004MW	Medium White
2004MBG	Medium Bright Green
2004MBO	Medium Bright Orange
2004MK	Medium Black
2004MP	Medium Pink
2004LY	Large Yellow
2004LB	Large Royal Blue
2004LR	Large Red
2004LW	Large White
2004LBG	Large Bright Green
2004LBO	Large Bright Orange
2004LK	Large Black
2004LP	Large Pink
2004XLY	XL Yellow
2004XLB	XL Royal Blue
2004XLR	XL Red
2004XLW	XL White
2004XLBG	XL Bright Green
2004XLBO	XL Bright Orange
2004XLK	XL Black
2004XLP	XL Pink
SPTBB/B/XXL	XXL Blue
SPTBB/Y/XXL	XXL Yellow
SPTBB/K/XXL	XXL Orange
SPTBB/G/XXL	XXL Green



PLAIN POLYESTER BIBS

2004W	White
2004K	Black
2004R	Red
2004RB	Royal
2004Y	Yellow
2004SKY	Sky Blue
2004M	Maroon
2004E	Emerald
2004P	Pink
2004BG	Bottle
2004PU	Purple
2004FO	Fluro Orange
2004FG	Fluro Green
2004NB	Navy Blue



ID NEOPRENE BANDS

2017R	Red - Small
2017B	Blue - Small
2017P	Purple - Small
2017FP	Fluro Pink - Small
2017FY	Fluro Yellow - Small
2017FG	Fluro Green - Small
2017FO	Fluro Orange - Small
2018R	Red - Large
2018B	Blue - Large
2018P	Purple - Large
2018FP	Fluro Pink - Large
2018FY	Fluro Yellow - Large
2018FG	Fluro Green - Large
2018FO	Fluro Orange - Large



FLURO VESTS

2016	Fluro Yellow
------	--------------



REVERSIBLE TRAINING SINGLETS

Breathable nylon mesh material. Can be worn with either colour outside to easily identify team members. Reinforced seams.

2011YRXS	Yellow/Red - XS
2011YRS	Yellow/Red - Small
2011YRM	Yellow/Red - Medium
2011YRL	Yellow/Red - Large
2011YRXL	Yellow/Red - XL
2011BPXS	Black/Pink - XS
2011BPS	Black/Pink - Small
2011BPM	Black/Pink - Medium
2011BPL	Black/Pink - Large
2011BPXL	Black/Pink - XL
2011RSXS	Royal/Sky - XS
2011RSS	Royal/Sky - Small
2011RSM	Royal/Sky - Medium
2011RSL	Royal/Sky - Large
2011RSXL	Royal/Sky - XL
2011OGXS	Orange/Green - XS
2011OGS	Orange/Green - Small
2011OGM	Orange/Green - Medium
2011OGL	Orange/Green - Large
2011OGL	Orange/Green - XL



WAIST BANDS / SASH

Available in Faction Colours, Orange and Purple.

2019R	Red
2019B	Blue
2019G	Green
2019Y	Yellow
2019O	Orange
2019P	Purple



TIDIES

2020	\$5.00
------	--------

MANUALS

Assorted manuals available
Learn to Swim CD

SAFETY EQUIPMENT

5406 Folding Stretcher
5407 Whistle Pealess
5408 Rescue Throw Bag



MARLIN AQUA SAILOR LIFE JACKETS

PDF Level 50 (Certified to AS 4758.1)

66954	Aqua Sailor Small 15-25kg
66956	Aqua Sailor Junior 25-40kg
66958	Aqua Sailor Small Adult 40-60kg
669510	Aqua Sailor Adult 60kg Plus
669512	Aqua Sailor Large Adult 60kg Plus
66955	Aqua Sailor XLarge 60kg Plus
6695M	Aqua Sailor 2XLarge 60kg Plus
6695L	Aqua Sailor 3XLarge 60kg Plus



LIFE SAVING RESCUE TUBE

5404



RESUSCITATION EQUIPMENT

5400 Manikin Wipes Box 50
5401 Chlorhexidine Solution
5402 Disposable Oxi Mask



LITTLE ANNE MANIKIN

5403



LIFE SAVING CAPS

Made from a Latex stretch material and available in almost any colour.

Minimum manufacturing order is twenty items of same style. These caps are made to order and take on average 2-3 weeks for manufacturing.

5405

Each

FINN AFINNTY

Moulded in one piece from high density UV retardant polyethylene, the Afinity is available with a kick up rudder and adjustable footrests making it easy to manoeuvre, even through the tea-trees on the Avon, and is easy to transport. Now with a higher front deck increasing forward buoyancy, the Afinity paddles drier and has increased lift through surf and white water, allowing the boat to be comfortably used in a wider range of paddling conditions.

The integral buoyancy provides added safety in the event of swamping while the internal aluminium keel rib adds rigidity to the hull to prevent slumping. The Afinity is faster than a wave ski as proven annually in the Avon Descent and is more stable than a surf ski making it easy to handle in all conditions even for beginners. The Afinity is listed as "Hire Boat Approved" by the Department of Transport.

'AFINNTY' DIMENSIONS

Length 4.25 metres

Beam 0.65 metres

Weight 18.5 kilograms

5450 Includes paddle

5451 Optional back rest



FINN GIZMO

A super stable 2.6m wave ski, designed for river, surf or white water. Lightweight 17kg allows easy transport & storage for paddlers of all ages. High back support for a comfortable seated position with lower back support. Multiple footwells (self draining for a drier paddling experience) allow paddlers of various heights to comfortably use this craft, and its superior stability makes it well suited to larger paddlers. The storage area has a removable container for small items, still allowing access into the craft for larger items (lunch, towel etc.).

The flat hull and twin keels allow great manoeuvrability on waves whilst maintaining excellent speed and tracking for distance paddling. The low volume bow is ideal for punching out through waves or leaning forward to duck dive through bigger waves. The GIZMO is listed as 'Hire Boat Approved' by the Department of Transport. Leg straps to provide greater stability & control.

'GIZMO' DIMENSIONS

Length 2.60 metres

Beam 0.72 metres

Weight 17.0 kilograms

SURF – FISH – KAYAK!

5452 Includes Paddle

5453 Deck liner

5454 BackRest

5455 Fishing Rod Holder



FINN REFLECTION CANOE

A classically designed open Canadian canoe, the Reflection is feature packed and exceptional value. The Reflection comes standard with three contoured (for comfort) seats with integral buoyancy, foam padded backrests, easy grab handles each end, keel rib for increased rigidity and two paddles. The inclusion of the foam padded backrests for each seat improves paddling posture, protecting the lower back of the paddler and allowing more time and enjoyment in the canoe.

One person can comfortably paddle the Reflection from the centre seat. Its multi-chine hull provides exceptional initial and secondary stability, and Swedehull hull shape allows extra load carrying capacity in the rear for single paddler or bracket mounted outboard, whilst maintaining excellent paddling speed and manoeuvrability. The tumblehome sides allow extra width and therefore stability without compromising paddle stroke.

'REFLECTION' DIMENSIONS

Length 4.25 metres

Beam 0.90 metres

Weight 35 kilograms

5456 Includes Paddle





SWELL HELMET **STANDARD**

Well ventilated to allow water to flow freely. Thick lining and padding for extra comfort. Adjustable chin strap.

5460



CANOE OR KAYAK PADDLE

Small diameter shaft for easy grip, plugged internally for floatation, sealed waterproof rivets, and tough polypropelene and dihedrale blades for antilflutter and better control.

5465 Canoe Paddle

5466 Kayak Paddle

SURFBOARDS **GNARLOO FATTY**

These boards have proven to be the best soft surfboards on the market. Best in performance so people can learn to surf well on them and best as far as usage goes. We have adopted the board inside a board principle that sees an EPS core with a wooden stringer shaped and glassed with epoxy resin. Then it is wrapped in materials that make the board soft. This principle ensures that you get the best of

both worlds. Firstly, a board that will perform really well as we can control the shape of the board and therefore the function of the board and secondly we can make the board as soft as it needs to be to provide optimum safety. All boards are constructed with heat lamination for added durability.

ALSO AVAILABLE WITH HANDLES ON SOME SIZES.

5470	6'
5471	6'6"
5472	7' 6"
5473	8' 4"
5474	9' 2"



CLUBLINE STANDARD PACK

CLUBLINE LINE MARKER
Easy to use - just switch on and mark

NOW WITH
LONG LIFE PUMP



2x
10L Ultra Line Marking Paint

- ✓ **ALL NEW LONG LIFE PUMP**
- ✓ **PNEUMATIC WHEELS**
- ✓ **BATTERY & CHARGER INCLUDED**
- ✓ **IDEAL FOR CLUBS AND SCHOOLS MARKING UP TO TWO OVALS**

FREE BATTERY & CHARGER INCLUDED

5501

PROLINE V4 PREMIUM PACK



PROLINE V4 LINE MARKER



2x
10L Xtreme Line Marking Paint
Twice the Concentrate &
Twice the Brightness

BONUS



30L CONTAINER
(for Colour Swapping)

- ✓ **FASTCLEAN™**
Cleans in seconds
- ✓ **QUICKMIX™**
Swap colours easily



FREE BATTERY & CHARGER INCLUDED

5500



Slater-Gartrell Sports are the Western Australian agents for Fountain Linemarkers.

We carry a wide range of parts and accessories for all Fountain models.

Please forward all enquiries to: sales@slatertrellsports.com.au or call (08) 9274 5788

LINE MARKING

THE PROFESSIONAL ATHLETICS BUNDLE



PROLINE V4 LINE MARKER

Australia and New Zealand's
No.1 Selling Line Marker



REVOLUTIONARY BOOM ATTACHMENT

- ✓ Save 80% marking time
- ✓ Maintain consistent line width
- ✓ Professional results guaranteed



3x

10L Ultra Line Marking Paint

Black or White



TOTAL VALUE \$3540

5500PB

Please visit www.slatertrellsports.com.au for up to date pricing.



Slater-Gartrell Sports are the Western Australian agents for Fountain Linemarkers.

We carry a wide range of parts and accessories for all Fountain models.

Please forward all enquiries to: sales@slatergartrellsports.com.au or call (08) 9274 5788



CLUBLINE MARKER

Fountain clubline marker holds 16 litres of linemarking fluid. Supplied fully assembled and boxed. Rated to give 700m of 50mm wide line of good visibility on mown grass. (Results may vary depending on conditions) Marking discs can be moved to mark a 50mm wide line up to a 100mm wide line.

Now with new long-life pump and FAST CLEAN™

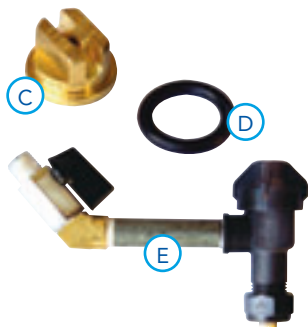
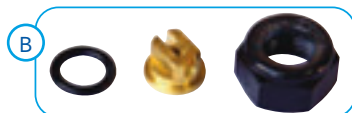

CLUBLINE PARTS

5502	A. Fountain Clubline Marker (Unit Price Only)
5511	B. Nozzle Complete
5512	C. Nozzle Spray Jet
5512	Duoflow Nozzle
5513	D. Nozzle O-Ring
5514	E. Reg Valve/Delivery Pipe Complete
CL02	F. Replacement Wheels Pair
CL03	G. Replacement Guide Discs Set - Including Axel
CL04	H. Replacement Switch
CL04	Diaphragm Valve Complete
CL05	Diaphragm Seal



CLUBLINE PUMP & MOTOR SET

5508 Universal



PROLINE V4 LIQUID MARKER

FountainLine is proud to present their all NEW ProLine V4 LineMarker. The new upgraded model means even sharper, brighter, lines than ever before! The new Quick Mix™ system allows you to mix your liquid in the removable container. The all new Fast Clean™ system makes cleaning quick and easy - simply connect your hose and your linemarker is cleared in seconds!

5503	Proline V4 Marker (Unit Price Only)
5506	Athletics Boom Attachment
PL01	Replacement Delivery Hose
PL02	Replacement 30L Container
PL03	Replacement Slide Rail & Discs
PL04	RDS Pump
PL05	Diaphragm Seal



The **FAST CLEAN™** system means easy cleaning! Connect your hose and your linemarker is cleared in seconds



QUICK MIX™ system means no messy transferring of paint products. Simply mix in the removable container. Easy Colour Swap.



Improved battery system! Simplified wiring and waterproof switch ensures trouble free operation.

V3 & V4 PUMP & MOTOR SETS

5520	Fountain Proline V4 Pump & Motor
------	----------------------------------

BATTERY & CHARGER

5525	Battery 12 volt (Metro Delivery Only)
5526	Trickle Charger



EZYLINE MARKER

Made to order product.
Please allow 4-6 weeks for Manufacturing.

Professional line marking on all grass sports fields has never been easier with FountainLine's NEW EzyLine Marker.

Simply pour in the line marking paint into the 20L container and you are ready to mark. And when you're finished marking simply pack away for next use.

Available in 75mm, 100mm, 125mm and 150mm.

- SAVE Time – No cleaning, battery charging or maintenance required.
- SAVE Effort – Simply fill with most types of sports field line marking paint and start line marking!
- SAVE Money – Low cost investment, the heavy duty metal body and extra durable rollers will last for years.

5504



FINELINE BOWLING GREEN MARKER

FountainLine's FineLine Marker makes line marking Bowling Greens Fast, Clean and Easy!

- Clean – Replace those messy stringline chalk marking techniques with the revolutionary FineLine.
- Easy – Simply fill the FineLine with the liquid concentrate and start marking.
- Professional Results – Get those arrow straight lines with the FineLine heavy duty and stable construction.
- Durable – uses FountainLine's leading liquid concentrate for longer lasting lines.

5505



AEROSOL MARKER

Convenient and effortless, Light weight – easy to carry, Bright sharp lines, Hard and soft surfaces, Variable line widths, 4 wheel marker for stability and accuracy.

5507 4 Wheel Aerosol Marker



**AEROSOL CANISTERS 500G
TO SUIT 4 WHEEL AEROSOL MARKER**

Factories, roads, carparks, sports areas. Ideal for small jobs and work on irregular surfaces. - Handy - Straight forward - no preparation - Variety of colours - Bright - Long lasting.

- 5530K Black
- 5530W White
- 5530R Red
- 5530Y Yellow
- 5530B Blue

Please visit www.slatergartrellsports.com.au for up to date pricing.



NEW PRONTO READY TO USE LINE MARKING PAINT

POWERFUL COVERAGE – Enhanced brightness and a weather resistant formula to ensure your fields last back-to-back game days.

READY TO USE – No diluting necessary, this paint is ready to use whenever you are. Saves time and increases productivity.

OUTSTANDING VALUE – Unbeatable price to quality ratio, leaving your wallet and fields happy.

NON-TRADITIONAL CONSUMPTION RATES – Ultra-low consumption rates due to the three nozzle types available. Stop using more paint than you have to based on the conditions of your field when you start line marking.

TIME SAVING – Convenience is key, 'Ready To Use' line marking paint and ultra-fast Drop & Go ProLine V4 means more fields marked in less time.

OPTIMISE – Make the most of your sports turf by using this economical paint line and do more with less for your club.

- RTU – No dilution required
- Brightness – Professional results every time
- Durable – Long lasting line marking
- Economical – Mark up to 4 fields per bucket
- Consistent Results – No need to measure ratio's
- Non Settling Formula – Long Shelf life
- Convenient – Save Time and Money
- Drop and Go – Use with existing FountainLine ProLine V4 with upgrade kit

PRONTO_K	Pronto Black 10L
PRONTO_W	Pronto White 10L
PRONTO_Y	Pronto Yellow 10L
PRONTO_B	Pronto Blue 10L
PRONTO_R	Pronto Red 10L
PRONTO_KIT	Pronto Upgrade Kit for Proline V4 Line Marker (Required)

ULTRA LIQUID 10L CONCENTRATE

Makes up to 90 litres, specifically designed to use on premium turf, Goes three times further than other liquids, Environmentally friendly, VOC, APEO and solvent free.

5531W	White
5531K	Black
5531R	Red
5531Y	Yellow
5531G	Green
5531B	Blue

Ultra Liquid 10L MAX CONCENTRATE

MARKED LENGTHS BASED ON 50MM LINE

Liquid - 10 litre pail. Dilute with water. 1 x 10 litre drum marks about 2-3 Soccer or Football fields 1 x 10L makes up to 90Litres of Liquid

DURABILITY

4 - 8 Weeks

ADVANTAGES

Use on hard or soft surfaces; Extremely bright; Highly concentrated; Excellent adhesion & wear resistance; very long lasting; Completely safe; Long storage life; Excellent value



LINE MARKING

GUIDE ONLY - Figures indicated are dependent on many factors including time of year, grass length, surface conditions, rain, temperature, as well as the person marking who influences the speed, concentration of the product etc. The figures do not allow for wear which may be anywhere from light to very heavy. A built-up line will last longer than a fresh new line.



XTREME WHITE OR BLACK 10L CONCENTRATE

Introducing FountainLine's unique, high-durability line-marking paint.

- 2X the brightness
- 2X the durability
- 2X the concentration

Mark twice as many fields with the same amount of paint. 1 x 10L tub now makes up to 160L of line-marking liquid.

All-weather Line Marking

XtremeWhite and XtremeBlack also includes our game-changing hydrophobic formula that lets you paint straight onto wet grass.

Advantages

- Save Time - High-durability pigments mean Xtreme lasts twice as long, so you only need to mark half as often.
- Save Money - Double the concentration means you can mark twice as many fields with the same amount of liquid.
- Save Waste - Our non-settling formula means longer storage life, simplifying stock ordering and eliminating wastage.
- Save Space - Our new 10L XtremeCube tubs occupy 40% less storage spaces, which also lowers freight and warehouse costs.
- Save Spillage - Square-corner tubs make for easy pouring, and include easy-to-follow dilution instructions.
- Reliable Results - For use in all types of liquid line markers. Manufactured under ISO9001 quality standards for consistent results every time.

5533	Xtreme White 10L Concentrate
5536	Xtreme Black 10L Concentrate

Please visit www.slatertrellsports.com.au for up to date pricing.

MANUFACTURING

5600	AFL Football Goal Posts	
1070	A. Archery Stand	
1660	B. Badminton Portable Stands Per Pair	
5601	Basketball Tower with ground sleeve heavy duty	
5602	Basketball/netball Tower Reversible With Sleeve HD	
2041	C. Basketball Ring Removable With plate	
2043	Basketball Ring Fixed	
2055	Basketball Ring Snap Down	
2063	D. Basketball Backboard Std 1800 x 1200 x 18mm	
2064	E. Basketball Backboard Std 1200 x 900 x 17mm	
5603	Beach Volleyball Posts	Per Pair
1178	G. Discus Trolley	
5604	H. Equipment Trolley	
5605	I. Gym Mat Trolley	
5610	J. Hockey Goals with Mesh, Wheels and Board	Per End
5611	Hockey Goals with Removable Net	Per End
5620	Netball Post with Ground Sleeve	Per End
5622	Netball Post with Sleeve Adjustable	Per Pair
5630	Rugby Posts with Ground Sleeves	
5631	K. Rugby / Soccer Combination	Per Pair
5632	Scoreboards	
1177	L. Shotput Trolley	
5640	Soccer Goals Full Size Permanent	Per Pair
5641	Soccer Goals Full Size Demountable	Per Pair
5643	Soccer Goals Jnr Size 4.5m x 2m	Per Pair
5606	M. Storage Cage (1200mm x 800mm x 800mm)	
5650	N. Tennis Posts with Winder Per Pair	
5651	Tennis Posts with Ground Sleeve, Winder and Cap	
5652	Volleyball Posts with Ground Sleeve	
1661	O. Volleyball Portable Stands Per Pair	
7815	P. Water Polo Goals	

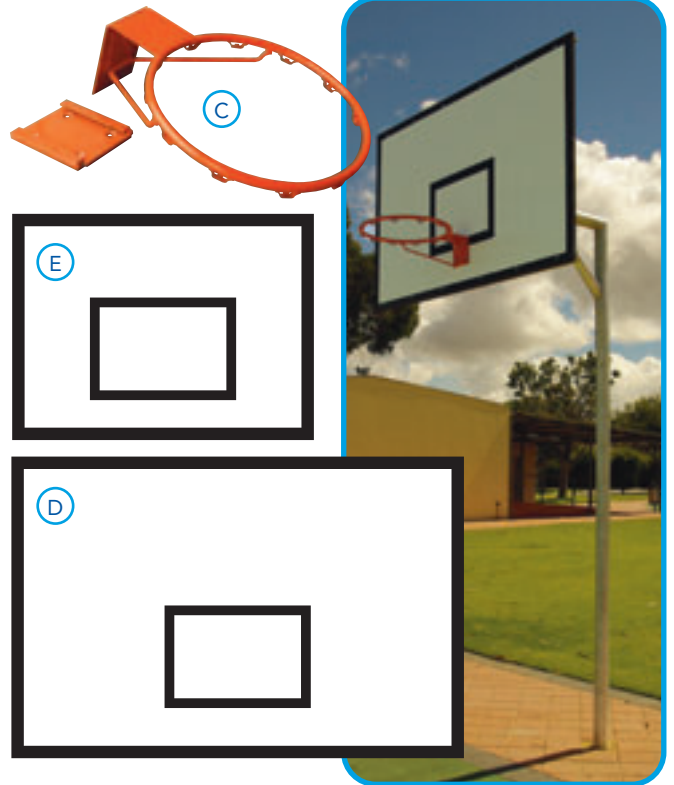

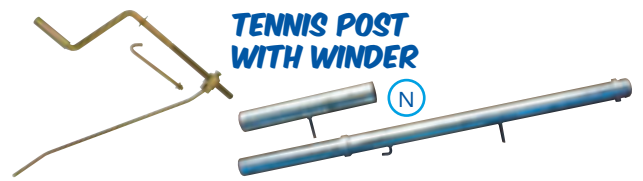

TENNIS POST WITH WINDER

(N)



(H)



(A)

ARCHERY STAND



(M)

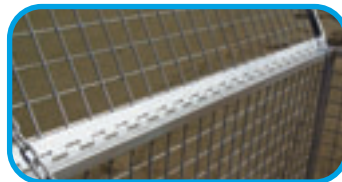

STORAGE CAGE

BADMINTON PORTABLE STANDS

(B)



SHOTPUT TROLLEY

(L)



(F)

COMBO SHOTPUT DISCUS TROLLEY



PORTABLE VOLLEYBALL STANDS

(O)



(G)

DISCUS TROLLEY

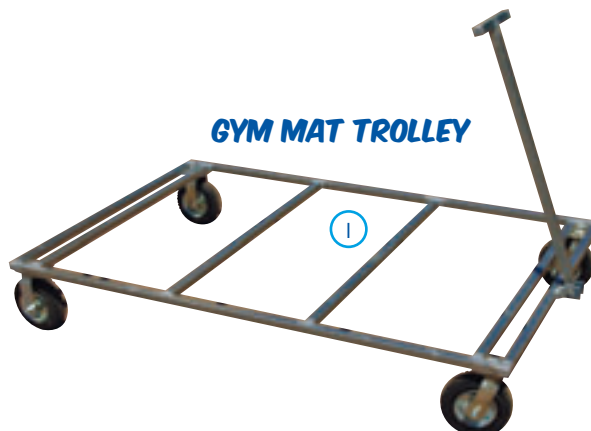

(I)

GYM MAT TROLLEY





**FLEXI MARKERS
COLLAPSIBLE SOLID
COLOURS**

5700R	19cm x 9cm - Red	Each
5700G	19cm x 9cm - Green	Each
5700Y	19cm x 9cm - Yellow	Each
5700W	19cm x 9cm - White	Each
5700B	19cm x 9cm - Blue	Each
5700O	19cm x 9cm - Orange	Each
5700PU	19cm x 9cm - Purple	Each
5700PI	19cm x 9cm - Pink	Each
FM01R	19cm x 5cm - Red	Each
FM01G	19cm x 5cm - Green	Each
FM01Y	19cm x 5cm - Yellow	Each
FM01W	19cm x 5cm - White	Each
FM01B	19cm x 5cm - Blue	Each
FM01O	19cm x 5cm - Orange	Each
FM01P	19cm x 5cm - Purple	Each
FM01PI	19cm x 5cm - Pink	Each
5700RP	Pack of 25 - Red	
5700GP	Pack of 25 - Green	
5700YP	Pack of 25 - Yellow	
5700WP	Pack of 25 - White	
5700BP	Pack of 25 - Blue	
5700OP	Pack of 25 - Orange	
5700PP	Pack of 25 - Purple	
30203	Pack of 25 - Pink	



**RUBBER FIELD
MARKER DISCS
PACK OF 10 WITH STAND**

- 20cm diameter
- Grid pattern on one side for improved grip on smooth surfaces
- Can be used indoors or outdoors
- Packet of 10
- Hole in the middle
- Stand Included

30142	White	
30143	Red	
30144	Blue	
30145	Yellow	
30146	Green	
30147	Orange	
30148	Pink	



**FLEXI MARKERS
COLLAPSIBLE MIXED
COLOUR PACKS**

5701	Pack of 50 - 9cm - Mix Colours with Stand	
FM50	Pack of 50 - 5cm - Mix Colours with Stand	



DOMES MARKERS

5706R	19cm x 9cm - Red	Each
5706Y	19cm x 9cm - Yellow	Each
5706W	19cm x 9cm - White	Each
5706B	19cm x 9cm - Blue	Each
5707	Marker Stand	
MDS40	Dome Markers - Set of 40	



**RUBBER FIELD
MARKER DISCS**

5708R	200mm Dia - Red	Each
5708G	200mm Dia - Green	Each
5708Y	200mm Dia - Yellow	Each
5708W	200mm Dia - White	Each
5708B	200mm Dia - Blue	Each
5708O	200mm Dia - Orange	Each
5708Z	200mm Dia - Purple	Each
5708P	200mm Dia - Pink	Each

**RUBBER FIELD
MARKER DISCS 10 PACK**

5709R	200mm - 10 Pack - Red	Pack
5709G	200mm - 10 Pack - Green	Pack
5709Y	200mm - 10 Pack - Yellow	Pack
5709W	200mm - 10 Pack - White	Pack
5709B	200mm - 10 Pack - Blue	Pack
5709O	200mm - 10 Pack - Orange	Pack
5709Z	200mm - 10 Pack - Purple	Pack
5709P	200mm - 10 Pack - Pink	Pack



**PLASTIC
MARKER FLAGS**

5710R	Red	Each
5710G	Green	Each
5710Y	Yellow	Each
5710B	Blue	Each
5710W	White	Each



SPIKE DISCS

5705R	Red	Each
5705G	Green	Each
5705Y	Yellow	Each
5705W	White	Each
5705B	Blue	Each



FLEXI DOME MARKER STAND MINI

SCDSTM Wire -14cm High



1-10 NUMBERED FLAT RUBBER FIELD MARKER DISCS

FNMD1 Numbered 1-10



11-20 NUMBERED FLAT RUBBER FIELD MARKER DISCS

FNMD2 Numbered 11-20



GROUND DISC SET NUMBERED 1-30

Very handy set of markers numbered One to Thirty that can be used for all kinds of circuits, station activities and games. Each blue disc is 12cm diameter and made of TPR rubber (Phthalate Free). Numerals are 7 cm high.

44106 Set of 30



LANE MARKER CONE SET 1-10

Set of 10 Lane Markers numbered 1-10 in White. Made from Fibreglass. Marker Size: Top: 430mm x 430mm. Base: 460mm x 460mm. Height: 46.5

LMC001

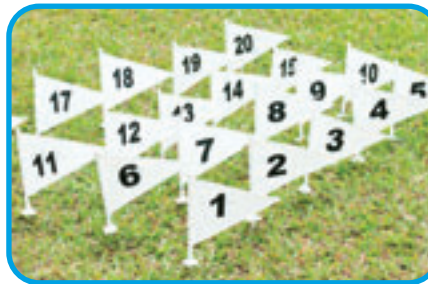

NUMBERED MARKING FLAGS 1-20

Numbered 1 to 20 on both sides and made from durable plastic approx 30cm high. Carry bag included.

44130



METAL ATHLETICS MARKERS

20 numbered athletic markers with carrier, constructed from hard wearing stainless steel.

1191 Set of 20 with Carrier



FIELD MARKER SET

Metal upright discs 9cm high, with black numbers 1-20 on one side only. Can be used for marking the start of the run up for long jump, high jump etc. or for any other temporary marking requirement.

1190



TRAINING CONES

- Sturdy lightweight moulded plastic cones
- Ideal to clearly mark out your training session

TC01O	23cm High - Orange
TC01Y	23cm High - Yellow
TC02O	30cm High - Orange
TC02Y	30cm High - Yellow



WITCHES HATS

5703	18"/450mm	Each
5704	28"/710mm	Each



MARKING CONES NUMBER SET OF 10

Set of 10 cones, numbered 1-10. Cones are 23cm high and come with 14cm high black numerals.

44104	Colours May Vary
-------	------------------



MINI WITCHES HATS

5702R	17cm High - Red	Each
5702G	17cm High - Green	Each
5702Y	17cm High - Yellow	Each
5702W	17cm High - White	Each
5702B	17cm High - Blue	Each



NUMBERED WITCHES HATS SET OF 10

5711	Set of 10	Each
------	-----------	------



PATRICK FLEXIBLE TRAFFIC CONE 36CM OR 51CM

These Orange Flexible Traffic Cones are safety cones used for sporting practice drills, traffic safety and control, hazard marking and a variety of other applications. Manufactured from UV stabilised high quality PVC rubber and stackable for ease of storage and transport. Made with a hi-vis orange colour for excellent daytime visibility, these cones are perfect for all your training and sport needs.

SPATCF3615	36cm High - Orange	Each
SPATCF5115	51cm High - Orange	Each



FLEXIBLE TRAFFIC CONE DELUXE 36CM OR 51CM

These Deluxe Orange Flexible Traffic Cones are safety cones used for sporting practice drills, traffic safety and control, hazard marking and a variety of other applications. Manufactured from UV stabilised high quality PVC rubber and stackable for ease of storage and transport. Made in a hi-vis orange colour and equipped with a reflective collar to assist with guidance for excellent daytime visibility, these cones are perfect for all your training and sport needs.

SPATCFD3615	36cm High - Orange	Each
SPATCFD5115	51cm High - Orange	Each



MULTIPURPOSE TRAINING CONE YELLOW

Introducing our high-quality Multipurpose Training Cones with holes in a vibrant yellow. These durable and flexible cones, made of robust plastic, come in a range of convenient heights and can withstand your toughest training sessions.

With multiple different hole heights, they seamlessly combine with hurdle poles, allowing you to create dynamic playing fields and hurdle courses. They are specifically designed so that the distance between each hole on all size cones are the same so that they can be utilised in many different ways. Perfect for coordination, sprint, jump, and agility training, these cones are a favourite among professional sports teams.

SPATTCM2306	23cm High - 12 Holes	Each
SPATTCM3006	30cm High - 8 Holes	Each
SPATTCM4306	43cm High - 12 Holes	Each
SPATTCM5306	53cm High - 16 Holes	Each



**SLATER-GARTRELL
SPORTS**

Serving WA Schools and Clubs Since 1978

**CUSTOM
MARQUEES
NOW AVAILABLE**

Serving WA Schools and Clubs Since 1978

	Qty	Stock Marquee	Custom Marquee
3m x 3m	1	\$884.00	\$1224.00
	2-5	\$816.00	\$1088.00
	6-9	\$748.00	\$1020.00
	10+	POA	POA
3m x 6m	1	\$1292.00	\$1904.00
	2-5	\$1224.00	\$1768.00
	6-9	\$1156.00	\$1700.00
	10+	POA	POA

CUSTOM HEAVY DUTY MARQUEES

If you're looking for a commercial grade, heavy duty marquee featuring a premium quality sublimation print, then look no further.

MARQUEE SPECS

Heavy Duty 40mm x 40mm Aluminium pipe marquee frame for extra strength. 500 Denier waterproof, PU Coated and flame retardant marquee canopies. Full colour dye sublimation printing for our custom canopies. All marquees come with a heavy duty roller bag, pegs and ropes.

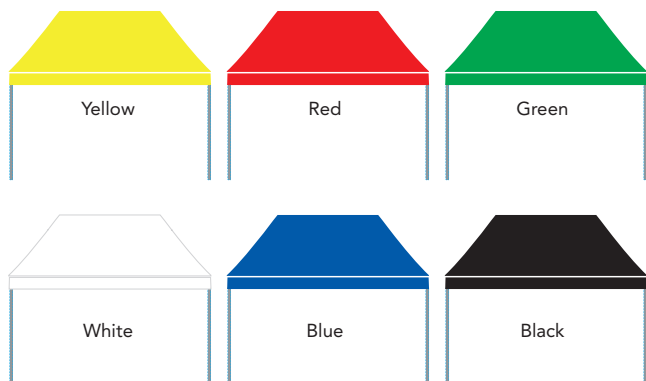

STOCK COLOURED MARQUEES

Our stock marquees come in 6 great colours, 2 sizes and are readily available. 40mm x40mm hexagonal aluminium pipe marquee frame for extra strength. 500D waterproof, PU coated and flame retardant marquee canopy. All marquees come with a heavy duty roller bag, pegs and ropes. Available in 6 great colours: Yellow, Red, Black, White, Blue & Green. Available in 2 sizes: 3m x 3m and 3m x 6m. Full and half walls and other accessories are also available.



CUSTOM DISPLAY FLAGS

The teardrop style flag features a 'triangular' eye-catching shape that is both stylish and trendy. The pole consists of a sectional aluminium design with a fibreglass tip. These flags are of lightweight yet durable design for easy installation and transportation. They are available in four different shapes being the Teardrop, Wing, Blade and Feather styles. A selection of different size flags are available with a variety of bases for soft or hard outdoor surfaces and indoor applications.

Please visit www.slatergartrellsports.com.au for up to date pricing.

MARQUEES



STRAPIT PREMIUM RIGID - TAPE

New and Improved – Strapit Premium (RED BOX) range of strapping tapes is a quality product at an economy price. Providing good support for joint stability and following injury, our premium range can be used in all sports where strapping tape is required.

58033	12.5mm Rigid Tape	Tube of 24 Rolls
58044	25mm Box Rigid Tape	Box of 48 Rolls
58055	38mm Box Rigid Tape	Box of 30 Rolls
58056	50mm Box Rigid Tape	Box of 24 Rolls
580333	12.5mm Tube Rigid Tape	Per Roll
580444	25mm Box Rigid Tape	Per Roll
580555	38mm Box Rigid Tape	Per Roll
580556	50mm Box Rigid Tape	Per Roll



STRAPIT EASYGRIP COHESIVE BANDAGE

Strapit Easyrip is a quality cohesive bandage that is sports specific in its ease of ripping when time is of the essence. It is a self-adherent lightweight dressing for injuries where sustained compression is required.

Features:

- Reliable compression & highly comfortable
- Easy to rip for clean & quick application
- Self-adherent
- Does not stick to the skin

5823	50mm	Box of 12 Rolls
5824	75mm	Box of 12 Rolls



STRAPIT PREMIUM FIXIT

New Strapit Fixit Premium is a hypoallergenic underwrap tape.

Features:

- Latex free adhesive.
- Ideal for use in conjunction with sportstape.

58311	5cm x 10m Roll	Per Roll
58312	10cm x 10m Roll	Per Roll



VAIFIX WRAP COHESIVE ELASTIC BANDAGE

- Ideal for strapping knees, ankles and all joints for support for all types of sporting activities
- Easy to use, sticks to itself not skin or hair.
- Nonslip support bandage, Water and sweat resistant
- Ideal for when controlled compression is required
- No clips or fasteners are needed
- Assorted colours

5809	50mm Roll	Carton of 36 Rolls
5810	100mm Roll	Carton of 18 Rolls



STRAPIT PROFESSIONAL STRETCH BAND PLUS

Adhesive medical and sports bandage for the use in the treatment and prevention of injuries. Ideal for joint protection, sprains and strains.

Features:

- Tan coloured.
- Excellent Adhesion.
- Ideal for shoulder strapping.

5828	50mm	Box of 12 Rolls
5829	75mm	Box of 12 Rolls



SUPPORTA 25MM X 4.5M ELASTIC THUMB TAPE

Premium quality elastic thumb tape

- Conformable elastic cotton substrate to assist taping of highly contoured/ joint body areas
- Zinc oxide adhesive ensures secure & strong support
- Ideal for bandaging fingers, toes & other sporting related applications
- Soft & light fabric for maximum patient comfort
- Dimensions- 25mm x 4.5m

58288	25mm x 4.5m	Box of 36
58299	25mm x 4.5m	Per Roll



MEDISPORTZ ICE COOL GEL PAD

- Stays cold for up to 8 hours of skin contact
- Stays cold long after opening package
- No ice or refrigerating required

5813 10 Pack



STRAPIT MEDI-ICE PADS

- Cools injury site within two minutes and stays cool for up to two hours, reusable by simply pouring the refill liquid over the bandage.

5820 10 Pack



INSTANT HEAT PACK

Instant hot packs generate heat via chemical reactions that occur once the package is punctured. Will go up to 21 degrees celcius from room temperature, lasts up to 15 minutes. Helps in relieving pain and swelling of minor injuries, bruises, cuts, muscle aches, sprains and headaches. Ideal for emergencies.

54066 Each

BANDAGES

MEDI HEAVY

5814	5cm x 2.3m	Ctn of 12 Rolls
5815	7.5cm x 2.3m	Ctn of 12 Rolls
5816	10cm x 2.3m	Ctn of 12 Rolls

WOUND CARE

MEDI CONFORMING DRESSING

5823	5cm x 7.2cm	Box of 50
5824	8cm x 10cm	Box of 20

WRAP FOAM

APE UNDER WRAP FOAM

5830	7.5cm x 25m
------	-------------

LEUKOFOAM

5831	10cm x 5m
------	-----------

MEDI AQUA ISLAND FILM

5826	6cm x 7cm	Box of 50
5827	10cm x 12cm	Box of 20

STERIPAD - LOW ADHERENT ABSORBANT DRESSING

58277	10cm x 10cm	Box of 50
-------	-------------	-----------



ADHESIVE STRIPS BANDAIDS BOX OF 100

For Minor Wound Care.

10004	Fabric 7.5cm x 2cm
10005	Plastic 7.5cm x 2cm



RESISTA MASSAGE TABLE (WITH ACCESSORIES)

Great quality portable massage table without the premium price. 186cm length x 68cm width.

Features:

- 5cm thick multi-layered Soft foam system
- Height range: 58-80cm
- Max working capacity: 500lbs/250kg
- Table top frame: selected high quality hardwood

Accessories Included:

- Ultra soft deluxe face cushion
- Standard adjustable aluminium face cradle
- A fully adjustable standard arm support
- A standard carrying bag with a sturdy shoulder sling and handles
- Stylish black upholstery.

5837



FOLDING STRETCHER

Made from high strength Aluminium alloy and Nylon mesh.

Folds conveniently, and includes carry bag with straps.

Orange colour

5406



SCOOP STRETCHER

Aluminium Scoop Stretcher for use in Sports First Aid.

Shipping Dimensions – 170cm x 7cm x 43cm

Weight 10kgs

Max user weight 159kg

5838



ICE SPRAY 200ML

Gives superficial and cooling relief, but cannot replace ice pack.

Note: Use with care, as it can cause frost bite on the skin.

5839



SELECT HOT & COLD PACK

The gel gives an optimal and long-lasting effect. Perfect for RICE treatment.

5840



COMPRESSION BINDING

All-purpose binding for Hot-Cold Pack and Ice Pack. The amazing insulating abilities of the neoprene give a more effective cooling.

5841



NEOPRENE ELBOW SUPPORT

Elbow Support with back in 4 mm SBR-neoprene providing optimal warmth effect and front in 1,5 mm SBR-neoprene ensuring flexibility in the joint. Offers warmth and support to the elbow. Suitable for strains and to minimize risk of future injuries

5842S Small

5842M Medium

5842L Large

5842XL XL



NEOPRENE KNEE SUPPORT

Knee Support in 4 mm SBR-neoprene. Provides warmth and support to the knee. Back in perforated neoprene increases flexibility and breathability

5843S Small

5843M Medium

5843L Large

5843XL XL



NEOPRENE OPEN KNEE SUPPORT

Open Patella Knee Support in 4 mm SBR-neoprene. Provides warmth and support to the knee. Back in perforated neoprene increases flexibility and breathability. Especially suitable for athletes who must avoid direct pressure on knee-shell. Aching tendons around the kneecap or pain from damaged cartilage on the inside of the patella are often relieved by using this type of knee support.

5844S Small

5844M Medium

5844L Large

5844XL XL



ELASTIC ELBOW SUPPORT

For the support and relief of muscles and joints.

5845S Small

5845M Medium

5845L Large

5845XL XL



ELASTIC KNEE OPEN SUPPORT

For the support and relief of muscles and joints. The hole ensures that no pressure is put on the knee cap.

5846S Small

5846M Medium

5846L Large

5846XL XL



ELASTIC KNEE SUPPORT

For the support and relief of muscles and joints.

5847S Small

5847M Medium

5847L Large

5847XL XL



SHOCK DOCTOR PRO STRAPLESS

Our sports mouth guard is suitable for all contact sports where a mouth guard is required or recommended like: football, basketball, lacrosse, hockey, MMA, boxing, jiu jitsu and much more. Boil & bite fit provides a comfortable fit and can be reformed as needed. Shock absorbing front bumper protects against impact.

SD001	Youth
SD002	Adult



SHOCK DOCTOR GEL MAX STRAPLESS

The Gel Max mouthguard delivers essential protection and comfort with a convertible tether that allows the mouthguard to be used strapped or strapless. This triple layer mouthguard provides a universal fit for all ages. Classic Fit: Traditional and original, all-around performer. Gel-Fit liner for tight, comfortable fit.

SD003	Youth
SD004	Adult



SHOCK DOCTOR GEL MAX FLAVOUR FUSION

The Gel Max Flavour Fusion Mouthguard delivers essential protection and comfort. This triple layer mouthguard provides a universal fit for all ages. Classic Fit: Traditional and original, all-around performer. Gel-Fit liner for tight, comfortable fit. Flavour Fusion Technology

SD005	Youth - Fruit Punch
SD006	Youth - Bubblegum
SD007	Youth - Lemon Lime
SD008	Youth - Blue Raspberry
SD009	Adult - Fruit Punch
SD010	Adult - Bubblegum
SD011	Adult - Lemon Lime
SD012	Adult - Blue Raspberry



SHOCK DOCTOR MICROFIT

Designed to provide the best 2.4 mm protection, this nextgen 2.4 mm mouthguard is a thin low profile fit design. A slim fit provides ultimate easy breathing and speaking with I-Mold technology for smooth contour and a high level of comfort after forming the mouthguard to each athlete's unique preference for fit. HMW Composite Blend for increased durability while maintaining fit and performance all season long. Slim Fit: Less material, lower profile, better breathability. Ultra custom fit, forms uniquely to your mouth. Best 2.4 mm Mouthguard in the market. Greatest deal on 2.4 mm max low profile guard. Lowest profile for easy breathing & speaking.

SD013	Adult
-------	-------



SHOCK DOCTOR SUPERFIT BASKETBALL

Communicate better with highly breathable and speak-able InVent tech. Developed to handle the hard court, hard elbows and hard shots of basketball. Sink into full coverage, ultra comfort and easy fitting...aka, Super. Sport Fit: Specialty models best used with certain sports. For enhanced court-running breathability & speak-ability. Light & tight custom protection.

SD014	Youth
SD015	Adult



SHOCK DOCTOR ULTRA BRACES

Ultra protection for athletes with braces. The Ultra Braces mouthguard outperforms conventional mouthguards through the genius combination of adjustability and durability in one package. The Insta-Fit Plus™ system allows athletes to mold and remold the mouthguard as teeth continue to adjust throughout orthodontic treatment. Braces Fit: Specifically developed for use with orthodontics. Triple layer protection for braces wearers. Moldable and remoldable after bracket adjustment.

SD016	Youth
SD017	Adult

SHOCK DOCTOR NANO DOUBLE FIGHT

Nano protection for upper and lower teeth for high impact sports. Perfect for MMA Fighters, Boxers and Jiu-Jitsu. This dual-arch, low profile mouthguard is designed to enhance upper and lower jaw protection. Featuring a double monocoque shock frame, it absorbs and disperses impact away from the point of contact. Classic Fit: Traditional and original, all-around performer. High-impact technology for high-impact sports. Protects, stabilizes both upper & lower teeth/jaw.

SD019	Youth
SD018	Adult





MOULDED RUBBER NETBALL

59002 Size 4
59003 Size 5



PATRICK TEAM CONTACT

59004 Size 4
59005 Size 5



PATRICK CLUB SURE SHOT

59014 Size 4
59015 Size 5



GILBERT D9 INSPIRE

59024 Size 4 Netta
59025 Size 5



MITRE INTERCEPT

59034 Size 4 Netta
59035 Size 5



GILBERT TRAINING

59044 Size 4
59045 Size 5



MITRE ULTRAGRIP

5905 Size 5



GILBERT MATCH

59064 Size 4
5906 Size 5



GILBERT GRIPSURE MATCH

30149 Size 5



CHAIN NET

2057



HD NYLON WHITE NET

2061



NYLON NET WHITE

2062



HD NYLON NET RAW/B

5932



ALL IN ONE STAND DELUXE

- 3 section design
- Suitable for Badminton, Tennis, Volleyball and Netball
- Each stand adjustable in height from 165cm to 305 cm
- Heavy duty square steel tubes for greater durability
- Pole (square =) 50mm
- Steel base frame for adding PORTABLE STAND WEIGHTS - 25KG to stabilise stand
- 25KG Portable weights sold separately (see: NBPSW25 - PORTABLE STAND WEIGHT 25 KG)
- Each stand frame can accommodate 4 x PORTABLE STAND WEIGHTS - 25KG adding a total weight of 200KG to the set
- 100mm wheels make moving easier
- Quick assembly
- Top attachment for volleyball net
- Ring attachment for Netball

100076



PORTABLE STAND WEIGHT 25KG

- Portable steel weight with carry handles
- 25kg per weight
- Used with ALLIANCE DELUXE STANDS

100077

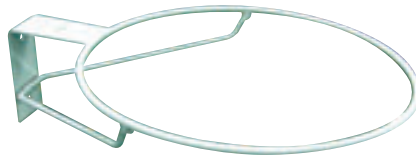

NETBALL RING BASIC FIXED

5938



NETBALL GOAL POST GUARDS

4167	3000 x 70mm	Each
4168	1800 x 70mm	Each



CHAIN NET NOT INCLUDED



PORTABLE NETBALL STAND HEAVY DUTY

5621	Free Standing HD	Each
------	------------------	------



NETBALL RING - HEAVY DUTY WITH NET HOOKS & BOLT PACK

The Heavy Duty Netball Ring is a heavy duty ring that features a sleek powder-coated white finish and net hooks. It comes with a nuts and bolts pack, allowing you to mount the ring on a wall, backboard or fixture.

Specifications:

- Powder coated steel rod ring
- Standard 38cm diameter
- Easy to assemble
- Includes 2x Hex Bolts, 2x Hex Nuts & 2x Flat Washers
- 2 Bolt fixing positions

00000



GILBERT BALL TUBE BAG

When travelling to and from a match, players need bags that easily carry their essentials. Gilbert have designed the Ball tube, perfect for carrying up to 5 netballs.

The ball tube is available in red, royal or black and has a single adjustable strap for easy transportation. To make it even simpler to navigate the ball type, half of the ball tube is made from mesh so the inside can be viewed but the bag maintains its strong makeup.

If you are a club or school looking a bag for away matches, the ball tube is exactly what you need.

30150	Blue
30151	Black
30152	Red



PLAIN POLYESTER BIBS

2004W	White
2004K	Black
2004R	Red
2004RB	Royal
2004Y	Yellow
2004SKY	Sky Blue
2004M	Maroon
2004E	Emerald
2004P	Pink
2004BG	Bottle
2004PU	Purple
2004FO	Fluro Orange
2004FG	Fluro Green
2004NB	Navy Blue



GILBERT REVERSIBLE NETBALL BIBS

- Pack of 7
- Regulation size
- Polyester material
- Ideal for clubs, schools or leisure
- Other side of bib is black

30045	Blue/Pink Junior
30044	Blue/Pink Senior
30039	Lime/Red Junior
30038	Lime/Red Senior



NETBALL BIB SET POLYESTER SET OF 7

2001JWK	Junior White/Black Ltrs
2001JKW	Junior Black/White Ltrs
2001JKP	Junior Black/Pink Ltrs
2001JRW	Junior Red/White Ltrs
2001JBW	Junior Royal/White Ltrs
2001JNW	Junior Navy/White Ltrs
2001JYB	Junior Yellow/Black Ltrs
2001JSB	Junior Sky/Black Ltrs
2001JBGW	Junior Bottle/White Ltrs
2001JMW	Junior Maroon/White Ltrs
2001JEB	Junior Emerald/Black Ltrs
2001JZW	Junior Purple/White Ltrs
2001JOB	Junior FL Orange/Black Ltrs
2001JGB	Junior FL Green/Black Ltrs
2001JPB	Junior FL Pink/Black Ltrs
2001SWK	Senior White/Black Ltrs
2001SKW	Senior Black/White Ltrs
2001SKP	Senior Black/Pink Ltrs
2001SRW	Senior Red/White Ltrs
2001SBW	Senior Royal/White Ltrs
2001SNW	Senior Navy/White Ltrs
2001SYB	Senior Yellow/Black Ltrs
2001SSB	Senior Sky/Black Ltrs
2001SBGW	Senior Bottle/White Ltrs
2001SMW	Senior Maroon/White Ltrs
2001SEB	Senior Emerald/Black Ltrs
2001SZW	Senior Purple/White Ltrs
2001SOB	Senior FL Orange/Black Ltrs
2001SGB	Senior FL Green/Black Ltrs
2001SPB	Senior FL Pink/Black Ltrs

CUSTOM NETBALL BIB SETS



BIB 18.5cm x 18.5cm
BIB 22cm x 18.5cm
BIB 16cm x 23cm
BIB 22cm x 20cm

INCLUDES:
7 POSITIONS
FRONT &
REAR BIBS
WITH VELCRO.

MADE TO ORDER IN YOUR TEAM COLOURS.

ALLIANCE REVERSIBLE NETBALL BIBS

- Pack of 7
- Regulation size
- Polyester material
- Ideal for clubs, schools or leisure
- Other side of bib is black

NBBSRJ0304	Red/Blue Junior
NBBSRJ0611	Yellow/Green Junior
NBBSRS0304	Red Blue Senior
NBBSRS0611	Yellow/Green Senior



OTHER NETBALL BIBS

2008	Special Make Up
2009	Printed Bib Single
2003	Plain Bib Single
2010	Special X-Large Set



NETBALL GLOVES

5937XS	Leather XS
5937S	Leather Small
5937M	Leather Med
5937L	Leather Large
5937XL	Leather XL



TIMER DELUXE

5934



TIMER STANDARD

5935



MAGNETIC STRIPS

2240	White: 50mm x 12mm (Pack 25)
2241	White: 60mm x 15mm (Pack 25)
2242	White: 75mm x 20mm (Pack 25)
2243	White: 100mm x 25mm (Pack 25)
2244	White: 125mm x 30mm (Pack 25)
2240Y	Yellow: 50mm x 12mm (Pack 25)
2241Y	Yellow: 60mm x 15mm (Pack 25)
2242Y	Yellow: 75mm x 20mm (Pack 25)
2243Y	Yellow: 100mm x 25mm (Pack 25)
2240O	Orange: 50mm x 12mm (Pack 25)
2241O	Orange: 60mm x 15mm (Pack 25)
2242O	Orange: 75mm x 20mm (Pack 25)
2243O	Orange: 100mm x 25mm (Pack 25)

ROUND MAGNETS

2245R	Red: Round 20mm (Pack 25)
2245Y	Yellow: Round 20mm (Pack 25)
2245B	Blue: Round 20mm (Pack 25)
2245W	White: Round 20mm (Pack 25)



Netball Folder

DELUXE NETBALL COACHING FOLDER

- Clip holder for note pad
- Magnetic whiteboard
- 25 magnetic name tags
- Marker pen
- Water resistant

2210	35cm x 46cm (Open)
------	--------------------



U-SHAPED MAGNETS

U001	Size: 60mm x 15mm (Pack 25)
U002	Size: 75mm x 25mm (Pack 25)
U003	Size: 100mm x 25mm (Pack 25)
U004	Size: 150mm x 25mm (Pack 25)



DIGITAL SPORTS TIMER

- Ideal for timekeeping
- Free standing
- Magnetic
- Used for player changes
- Timing of 1/4 and 1/2
- Long battery life

SDT01



Netball Board (Front)



Netball Board (Back)

NETBALL BOARD

- Magnetic whiteboard front and back
- 25 magnetic name tags
- Write on and wipe off
- Marker pen and pen clip
- Carry handle
- Lightweight and sturdy construction

2218	Size: 30cm x 40cm
------	-------------------



POLYESTER PONCHOS

- PU coated waterproof Micro-ripstop polyester.
- Auscam is non-ripstop.
- Waterproof taped seams
- Draw cored hood
- Re-enforced stitching around neck line and opening
- 2000mm waterhead rating
- 200 cm x 127 cm
- Available in Auscam, Olive, Navy and Green
- Weight: 200g

100146	Green
100147	Navy
100148	Olive
100149	AUSCAM



XPE MAT

Made to be lightweight with high density Ideal to keep dampness away from the body.

- Hard wearing and durable
- Made of XPE Polyethylene
- Closed cell foam
- Size: 180 x 60 cm
- Thickness: 1 cm
- Weight: 305g

100150	Green	\$17.00
--------	-------	----------------



SAFETY WHISTLE

- Safety whistle in HUNTER GREEN or ORANGE
- Can be heard over 1 mile away
- Used by rescue professionals world- wide
- Official referees whistle

100151	Hunter Green
100152	Orange



PATROL SLEEPING BAG

- -5 and -12 degree rated
- Military specification
- 2000 mm water head rating
- Reinforced oxford inner liner for boots
- Box foot / Nylon base /2 x YKK zips
- Contoured hood/ zip-out mozzie net
- Rip-stop Nylon upper
- Anti-bacterial aluminate mesh liner with microfiber fill

100153	-5 Degree Sleeping Bag	\$58.00
100154	-12 Degree Sleeping Bag	\$99.00



POLYCARBONATE MESS KIT

Sturdy, take anywhere dishes and cutlery.
Comes in a mesh carry bag with drawcord

Set includes:

- Plate: 25cm
- Bowl: 16cm
- Mug: 7.5cm
- Knife: 21.5cm
- Fork: 18.5cm
- Spoon: 15.5cm
- Available in Blue or Charcoal Brown
- Weight: 405g

100155	Blue
100156	Charcoal Brown



CAMPING COOK SET - 7 PIECE

100159



URBAN PANTHER RUCKSACK

- Fully adjustable harness system
- Sturdy hip belt
- Hydration system compatible
- Side compression
- Base load straps
- Rope strap
- Expandable side pockets
- 2 pockets in the top cover
- Adjustable chest straps
- Walking pole/ ice axe attachments
- Rain cover

100157



URBAN COUGAR RUCKSACK

- Fully adjustable harness system
- Sturdy hip belt
- Hydration system compatible
- Side compression
- Base load straps
- Rope strap
- Expandable side pockets
- 2 pockets in the top cover
- Adjustable chest straps
- Walking pole/ ice axe attachments
- Rain cover

100158



HEAVY DUTY GAITER

- Heavy duty 900D 2 coats PU fabric
- ¾ length gaiter
- Velcro sides with press studs
- Articulated cut
- Underfoot strap
- Black also has a zipper
- Weight: 400g

100160	AUSCAM
100161	BLACK
100162	CAMMO



FULL LENGTH MERINO WOOL SOCK

- 100% Australian made
- 85% Merino wool + 15% nylon

100165	BLACK
--------	-------



POLYPRO THERMALS

- Made with 185gsm polypropylene fabric
- Hydrophobic, moisture wicking properties
- Non-clinging fabric
- Ideal as a first layer
- Available in Black and Navy

100163	BLACK TOP
100164	NAVY TOP
100164B	BLACK PANT
100164N	NAVY PANT



EXPLORE TENT

- Flysheet: 185T Polyester, PU coating
- 5000mm water head rating
- Taped seams on fly sheet and floor
- Inner: 180T breathable polyester
- Floor: 150D Oxford, PU coating
- 5000mm water head rating
- Poles: 2 Shock corded Dura-aluminium poles
- Outer bag: 150D Oxford, PU waterproof coating, 2 roomy pockets for equipment
- Includes: 12 Iron pegs, 6 Windproof guy lines for storm protection
- Packed down: 50x12cm
- 60+125+60cm wide x 210cm long x 110cm high
- Weight: 2.2kg

100166



PEAK TENT

- Flysheet: 185T Polyester, PU coating
- 5000mm water head rating
- Taped seams on fly sheet and floor
- Inner: High quality mesh
- Floor: 150D Oxford, PU Coating
- 5000mm water head rating
- Poles: 2 Shock corded Dura-aluminium poles
- Outer bag: 150D Oxford PU waterproof coating
- 2 Roomy pockets for equipment
- Packed down: 50x14cm
- Set up: 60+130+30cm wide x 210cm long x 100cm high
- Weight: 2.2kg

30153



JUNIOR PRIMARY CLASSROOM KIT

- 90 cm team bag • 1 x soccer ball 3 • 2 x 4" pimple ball
- 2 x 7" pimple ball • 1 x std frisbee • 2 x 14ft skipping ropes
- 1 x jnr football • 1 x oz cricket bat • 1 x 8" mini pink dodge ball
- 12 x loose tennis balls • 1 x grip ball set

6000



MIDDLE PRIMARY CLASSROOM KIT

- 90 cm team bag • 1 x basketball 5 • 1 x netball 4
- 1 x soccerball 4 • 1 x jnr football • 12 x loose tennis balls
- 1 x 8" play ball • 1 x oz cricket bat • 4 x plastic hand bats
- 2 x std frisbees • 2 x 14ft skipping ropes

6001



SENIOR PRIMARY CLASSROOM KIT

- 90 cm team bag • 1 x oz cricket bat • 1 x stump end
- 2 x oz cricket balls • 1 x basketball 6 • 1 x netball 5
- 1 x soccerball 5 • 1 x football 5 • 12 x loose tennis balls
- 1 x mini pink dodge ball • 2 x std frisbees

6002



RECREATION / CAMP KIT

- 120 cm team bag • 1 x quoit set • 1 x bocce set • 1 x vortex
- 1 x rubber soccerball • 2 x std frisbee • 1 x oz cricket bat
- 1 x stump end • 1 x touch ball • 12 x loose tennis balls
- 4 x Flexi Markers • 1 x SG Plastic Whistle with Lanyard

6003

Please visit www.slatertrellsports.com.au for up to date pricing.



BEAN BAGS

Colourful Vinyl or Nylon Beanbags

1252R	Vinyl Red
1252G	Vinyl Green
1252B	Vinyl Blue
1252Y	Vinyl Yellow
1253R	Nylon Red
1253G	Nylon Green
1253B	Nylon Blue
1253Y	Nylon Yellow



FRISBEES

6012	A. Professional SG
6013	Standard SG
6014	B. Ultimate Frisbee
6015	C. Aerobie Pro 10"
6016	D. Aerobie Pro 12"
FRIS6	Frisbee Set of 6 Colours



BOCCE / BOULE

6004	A. Metal
6005	Plastic - Small
6006	B. Plastic - Large



DART BOARDS

6007	Dart Board Vapor
6008	Dart Board Dot Trainer
6009	Dart Board Gladiator



DARTS

6010	Darts Blaster Standard
6011	Darts Burst Deluxe



TUFF GATOR SKIN DODGEBALLS.

6020R	Soccer Ball 213mm Red
6020B	Soccer Ball 213mm Blue
6020G	Soccer Ball 213mm Green
6020Y	Soccer Ball 213mm Yellow
60216	210mm Set of 6 Colours
60226	160mm Set of 6 Colours



MONARCH 4L METAL PAINT BUCKET

Ideal Bucket for Flag Race.

1661933

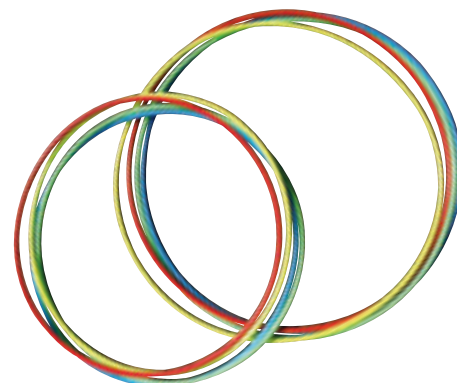

PLASTIC HOOPS

Available in 24" (61cm) or 30" (76cm)

1256R	24" Red
1256G	24" Green
1256B	24" Blue
1256Y	24" Yellow
1257R	30" Red
1257B	30" Blue
1257G	30" Green
1257Y	30" Yellow
1258R	24" Red (5 Pack)
1258B	24" Blue (5 Pack)
1258G	24" Green (5 Pack)
1258Y	24" Yellow (5 Pack)
1259R	30" Red (5 Pack)
1259B	30" Blue (5 Pack)
1259G	30" Green (5 Pack)
1259Y	30" Yellow (5 Pack)



FLAG RACE FLAGS

Ideal for sports carnivals or classroom activities.

1255R	Red Flag	Each
1255G	Green Flag	Each
1255B	Blue Flag	Each
1255Y	Yellow Flag	Each
1255K	Black Flag	Each
1255W	White Flag	Each

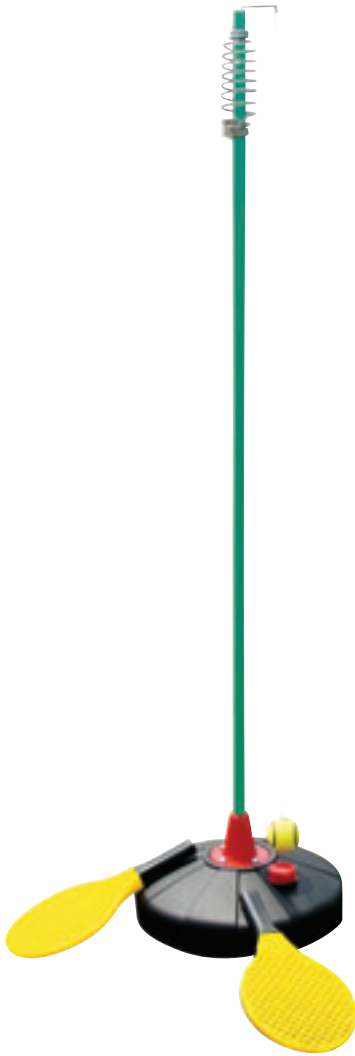

TOTEM/ORBIT TENNIS SET

- 6044 Spin Tennis Water Filled Base
- 6045 Replacement Totem Ball

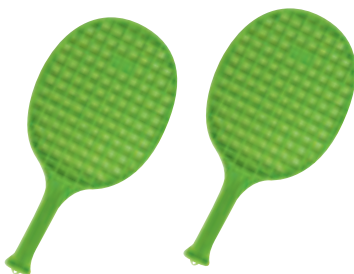

TOTEM/ORBIT TENNIS REPLACEMENT BATS

- | | | |
|-------|--------|------|
| 6044G | Green | Each |
| 6044R | Red | Each |
| 6044B | Blue | Each |
| 6044Y | Yellow | Each |



VORTEX AERO HOWLER SENIOR

Go long with the Nerf Sports Vortex Aero Howler football! This foam ball howls as it flies through the air, and the long-distance tails sends it flying far. A hand grip lets players get a firm grip on the ball to help them better target their passes.

- 6025 30cm Long



VORTEX POCKET AERO FLYER JUNIOR

The Nerf Sports Pocket Aero Flyer ball goes the distance! This small foam football has a tail with 3 fins to help it fly farther when thrown. Practice passing or start a pick-up game; tuck it in a pocket or backpack to bring it everywhere and get a game going anytime! Nerf and all related properties are trademarks of Hasbro.

- 6054 17cm Long



FRISBEE GOLF BASKET

- 16140



FRISBEE GOLF DISC SET

- 16141



PLAYGROUND BALL 5 OR 8 INCH

Special two-ply construction for safety, soft handling and durability

- Diameter: 8 inch - 20.32cm.
- Diameter: 5 inch - 12.7cm

- | | |
|--------|-----------|
| 100017 | Blue 8" |
| 100018 | Yellow 8" |
| 100019 | Red 8" |
| 100020 | Green 8" |
| 1000B5 | Blue 5" |
| 1000Y5 | Yellow 5" |
| 1000R5 | Red 5" |
| 1000G5 | Green 5" |



MINI PINK DODGE BALLS

- 6047 8" - 200mm
- 6048 6" - 150mm

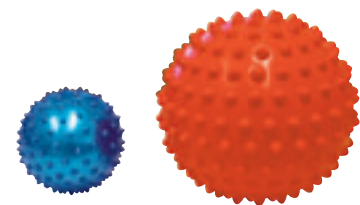

SPIKE BALLS DELUXE

- 6053 Spike 7" - 180mm



**COMPRESSOR
HEAVY DUTY**

- 4243 Compressor
- 4245 Replacement Compressor Hose



**COMPRESSOR
DELUXE**

- 4244
- 4245 Replacement Compressor Hose



TUG-O-WAR ROPE

- Heavy Duty Tug of War Rope 20m long. (2.5cm Dia)
- 126022 22 Metre
 - 126030 30 Metre



**MULTI BALL
INFLATION DEVICE**

Inflate up to 11 balls at the one time with this innovative multi ball inflation device.

Note: Balls not included.

MBID01

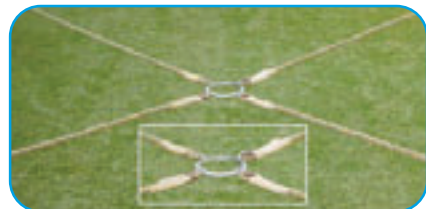

**TUG-O-WAR ROPE
JUTE 4 WAY**

- 12604W 5m Long Ropes



**PATRICK
DUAL ACTION PUMP**

- Dual action: expels air on both push and pull actions
- Ball inflation valve and toning ball adaptors included

30037



**HAND PUMP
STANDARD**

4249



STRING BAGS

- 2033 Large - Holds 14 Basketballs
- 2034 Medium - Holds 8 Basketballs
- 2035 Small



**HAND PUMP
HEAVY DUTY**

4242



**AIR HORN
COMPLETE KIT
DELUXE**

Acoustic horn signal. Push button plastic top air horn. Includes 300ml aerosol can.

- 1274 A. Air Horn Complete Kit
- 1275 B. Air Horn Refill Can 300ml



**AIR HORN
COMPLETE KIT
STANDARD**

Acoustic horn signal. Push button plastic top air horn. Includes aerosol can in kit.

- 30015 A. Air Horn Complete Kit
- 30016 B. Air Horn Refill Can
- 30017 C. Replacement Horn



GAMES

33187	A. Bean Bag Balls
6029	Knotted Climbing Rope
16150	B. Grip Balls Set
6031	Grip Balls Spare x 2
6032	C. Scoop Ball Set
6033	D. Quoits Top Score Rope
123CSD	Croquet Set Deluxe



POOL CUES WITH GLUE ON TIPS

6055	Standard 1 Pce Cue Match
6056	Standard 2 Pce Cue Match

POOL & SNOOKER ACCESSORIES

6064	Spider
6065	Corner Pool Cue Stand
6066	Wall Pool Cue Rack



POOL & SNOOKER BALLS

6057	Snooker Balls 1 7/8"
6058	Pool Balls 1 7/8"

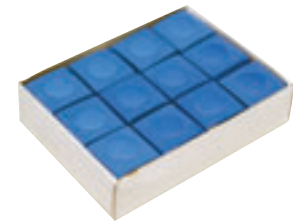

POOL & SNOOKER CHALK

6059	Box of 12
------	-----------



POOL CUE TIPS

6060	Screw In	Pack
6061	Glue On	Pack
6062	Ferrules Nylon	Pack

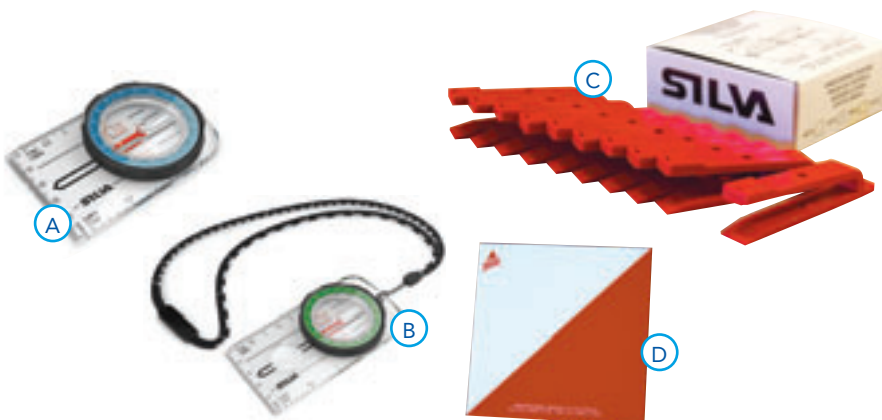

ORIENTEERING

6070	A. Silva Field Compass Primary	
6071	B. Silva Ranger Compass Secondary	
6073	C. Control Punches Set "Type A"	Set of 10
6073B	C. Control Punches Set "Type B"	Set of 10
6074	D. PVC Tree Control Markers	
6075	Field 7 - 28 Pce in Carry Bag	
6076	Ranger - 28 Pce in Carry Bag	



POOL & SNOOKER TRIANGLE

6063S	Small 1" 7/8'
6063L	Large 2"



INFLATOR NEEDLES

4250	Thick
4251	Thin



**PLACE RIBBONS
PVC 150MM X 35MM**

14101	1st Place	Each
14102	2nd Place	Each
14103	3rd Place	Each
14104	4th Place	Each
30023	I Swam in a Race	Each
30024	I Ran in a Race	Each



**PLACE RIBBONS
PVC 100MM X 29MM**

14111	1st Place	Each
14112	2nd Place	Each
14113	3rd Place	Each
14114	4th Place	Each



**PLACE RIBBONS
SATIN 150MM X 35MM**

14121	1st Place	Each
14122	2nd Place	Each
14123	3rd Place	Each
14124	4th Place	Each
1412C	Custom*	Each

*\$100.00 Setup fee for custom ribbons.
Minimum order quantity is 100pcs



**I'M A GOOD SPORT
PVC 100MM X 29MM**

1413	Each
------	------



WELL DONE PVC

WD02	Each
------	------



I RAN IN A RACE PVC

1415	Each
------	------



**I TOOK PART
IN AN EVENT PVC**

1416	Each
------	------



SUPER EFFORT SATIN

1417	Each
------	------



I'M A GOOD SPORT SATIN

1418	Each
------	------



**I TOOK PART
IN AN EVENT SATIN**

1419	Each
------	------



BRASS PINS

19mm long brass pins. (100pcs)

1430	Each
------	------



**PLACE CARDS PADS
80MM X 80MM**

14351	1st Place	50 Per Pad
14352	2nd Place	50 Per Pad
14353	3rd Place	50 Per Pad
14354	4th Place	50 Per Pad



**FLEXI MARKERS
COLLAPSIBLE
SOLID COLOURS**

5700R	19cm x 9cm - Red	Each
5700G	19cm x 9cm - Green	Each
5700Y	19cm x 9cm - Yellow	Each
5700W	19cm x 9cm - White	Each
5700B	19cm x 9cm - Blue	Each
5700O	19cm x 9cm - Orange	Each
5700PU	19cm x 9cm - Purple	Each
5700PI	19cm x 9cm - Pink	Each
FM01R	19cm x 5cm - Red	Each
FM01G	19cm x 5cm - Green	Each
FM01Y	19cm x 5cm - Yellow	Each
FM01W	19cm x 5cm - White	Each
FM01B	19cm x 5cm - Blue	Each
FM01O	19cm x 5cm - Orange	Each
FM01P	19cm x 5cm - Purple	Each
FM01PI	19cm x 5cm - Pink	Each
5700RP	Pack of 25 - Red	
5700GP	Pack of 25 - Green	
5700YP	Pack of 25 - Yellow	
5700WP	Pack of 25 - White	
5700BP	Pack of 25 - Blue	
5700OP	Pack of 25 - Orange	
5700PP	Pack of 25 - Purple	
5700PP	Pack of 25 - Pink	



**RUBBER FIELD
MARKER DISCS
PACK OF 10 WITH STAND**

- 20cm diameter
- Grid pattern on one side for improved grip on smooth surfaces
- Can be used indoors or outdoors
- Packet of 10
- Hole in the middle
- Stand Included

30142	White
30143	Red
30144	Blue
30145	Yellow
30146	Green
30147	Orange
30148	Pink



**FLEXI MARKERS
COLLAPSIBLE MIXED
COLOUR PACKS**

5701	Pack of 50 - 9cm - Mix Colours with Stand	\$38.00
FM50	Pack of 50 - 5cm - Mix Colours with Stand	\$35.00



DOMES MARKERS

5706R	19cm x 9cm - Red	Each
5706Y	19cm x 9cm - Yellow	Each
5706W	19cm x 9cm - White	Each
5706B	19cm x 9cm - Blue	Each
5707	Marker Stand	
MDS40	Dome Markers - Set of 40	



**RUBBER FIELD
MARKER DISCS**

5708R	200mm Dia - Red	Each
5708G	200mm Dia - Green	Each
5708Y	200mm Dia - Yellow	Each
5708W	200mm Dia - White	Each
5708B	200mm Dia - Blue	Each
5708O	200mm Dia - Orange	Each
5708Z	200mm Dia - Purple	Each
5708P	200mm Dia - Pink	Each

**RUBBER FIELD
MARKER DISCS 10 PACK**

5709R	200mm - 10 Pack - Red	Pack
5709G	200mm - 10 Pack - Green	Pack
5709Y	200mm - 10 Pack - Yellow	Pack
5709W	200mm - 10 Pack - White	Pack
5709B	200mm - 10 Pack - Blue	Pack
5709O	200mm - 10 Pack - Orange	Pack
5709Z	200mm - 10 Pack - Purple	Pack
5709P	200mm - 10 Pack - Pink	Pack



TRAINING CONES

- Sturdy lightweight moulded plastic cones
- Ideal to clearly mark out your training session

TC01O	23cm High - Orange
TC01Y	23cm High - Yellow
TC02O	30cm High - Orange
TC02Y	30cm High - Yellow



WITCHES HATS

5703	18"/450mm	Each
5704	28"/710mm	Each



**1-10 NUMBERED
FLAT RUBBER FIELD
MARKER DISCS**

FNMD1 Numbered 1-10



**11-20 NUMBERED
FLAT RUBBER FIELD
MARKER DISCS**

FNMD2 Numbered 11-20



SPIKE DISCS

5705R	Red	Each
5705G	Green	Each
5705Y	Yellow	Each
5705W	White	Each
5705B	Blue	Each



**GROUND DISC SET
NUMBERED 1-30**

Very handy set of markers numbered One to Thirty that can be used for all kinds of circuits, station activities and games. Each blue disc is 12cm diameter and made of TPR rubber (Phthalate Free). Numerals are 7 cm high.

44106 Set of 30



**PLASTIC
MARKER FLAGS**

5710R	Red	Each
5710G	Green	Each
5710Y	Yellow	Each
5710B	Blue	Each
5710W	White	Each



**NUMBERED
WITCHES HATS**

5711 Set of 10 Each



**PATRICK FLEXIBLE
TRAFFIC CONE
36CM OR 51CM**

These Orange Flexible Traffic Cones are safety cones used for sporting practice drills, traffic safety and control, hazard marking and a variety of other applications. Manufactured from UV stabilised high quality PVC rubber and stackable for ease of storage and transport. Made with a hi-vis orange colour for excellent daytime visibility, these cones are perfect for all your training and sport needs.

SPATCF3615	36cm High - Orange	Each
SPATCF5115	51cm High - Orange	Each



**FLEXIBLE
TRAFFIC CONE DELUXE
36CM OR 51CM**

These Deluxe Orange Flexible Traffic Cones are safety cones used for sporting practice drills, traffic safety and control, hazard marking and a variety of other applications. Manufactured from UV stabilised high quality PVC rubber and stackable for ease of storage and transport. Made in a hi-vis orange colour and equipped with a reflective collar to assist with guidance for excellent daytime visibility, these cones are perfect for all your training and sport needs.

SPATCFD3615	36cm High - Orange	Each
SPATCFD5115	51cm High - Orange	Each



**MULTIPURPOSE
TRAINING CONE YELLOW**

Introducing our high-quality Multipurpose Training Cones with holes in a vibrant yellow. These durable and flexible cones, made of robust plastic, come in a range of convenient heights and can withstand your toughest training sessions.

With multiple different hole heights, they seamlessly combine with hurdle poles, allowing you to create dynamic playing fields and hurdle courses. They are specifically designed so that the distance between each hole on all size cones are the same so that they can be utilised in many different ways. Perfect for coordination, sprint, jump, and agility training, these cones are a favourite among professional sports teams.

SPATTCM2306	23cm High - 12 Holes	Each
SPATTCM3006	30cm High - 8 Holes	Each
SPATTCM4306	43cm High - 12 Holes	Each
SPATTCM5306	53cm High - 16 Holes	Each



PICKLEBALL BALL

100141	Indoor	Each
100141O	Outdoor	Each



PICKLEBALL NET

30210	Each
-------	------



PICKLEBALL PADDLE

30209	Each
-------	------



E-JET SPORT PICKLEBALL 4 PACK - OUTDOOR

- High-visibility yellow color ensures easy tracking of the ball
- Made from durable materials to withstand the rigors of outdoor play
- 4 x pickleballs in mesh drawstring bag

PBEB4PO	4 Pack
---------	--------



E-JET SPORT PICKLEBALL FIBREGLASS PADDLE

- Fiberglass construction ensures a lightweight paddle that's built to last
- Smooth fiberglass surface offers exceptional ball control for accurate shots
- Generate power and spin with ease

PBEPF



E-JET SPORT PICKLEBALL FIBREGLASS PADDLE

- Wooden construction provides a classic and traditional feel
- Known for their durability and reliability over time
- Excellent for precise ball control and placement

PBEPWD



E-JET SPORT PICKLEBALL 4 PLAYER WOODEN SET WITH NET

Experience the ultimate in pickleball fun with the E-Jet Sports Pickleball 4 Player Set. This set comes complete with a 304.8cm portable quick setup net stand, 4 wooden paddles, 4 balls (2 for indoor and 2 for outdoor play), and a convenient carry bag for easy storage and transport. Perfect for players of all ages, it's your ticket to endless pickleball excitement.

PBES4PWS



E-JET SPORT PICKLEBALL 2 PLAYER WOODEN SET STANDARD

- 2 x paddles, 2 x outdoor balls, and a mesh bag
- Durable wooden paddles for hours of play
- Easy-to-grip contoured handles

PBES2PWS	2 pack
----------	--------



CRAZYCATCH PROFESSIONAL DOUBLE TROUBLE

The largest option Crazycatch, ideal for group activities. Perfect for Schools, Clubs and Families that have the space. It features a large rebound area, with a heavy duty frame and components. It can be configured with a horizontal or vertical frame orientation. Both sane (predictable rebound) one side and insane (unpredictable rebound) on the other. Perfect for all age groups and skill levels. Great for practicing longer distance throwing and catching!

1480mm(w) x 910mm(h)

Includes: Crazycatch level 2 vision Ball, Crazy catch timer, Activity pack with Scorecard and Throwing targets.

PRODT Pro Double Trouble



CRAZYCATCH WILD CHILD DOUBLE TROUBLE

Ideal size for indoor or outdoor use and convenient to take to the beach or park. Features same heavy duty frame and components as the Professional. Features same heavy duty frame and components as the Original – perfect for the developing and serious sportsperson.

The portable indoor/outdoor option for the developing and serious sportsperson with 30% more rebound area than the upstart. Double the insane action, one side designed for unpredictable small ball rebound, the other designed for large balls like soccer, netball and basketball. If you play a variety of sports then this will be the right product for you.

930mm(w) x 930mm(h)

Includes: Crazycatch level 2 vision ball, Crazycatch timer, Activity pack with scorecard, New Freestyle features, Throwing targets and Carry bag.

WC001 Wild Child Double Trouble



CRAZYCATCH UPSTART 2.0

The Crazy Catch Upstart 2.0 is our smallest and most portable freestanding sport rebound net.

This tough little nylon net comes with two sides, one for SANE (predictable) rebounds to sharpen hand-eye coordination and the other for INSANE (unpredictability) rebounds to improve reaction time.

The tough steel build and rugged nylon nets are built for years of hard training.

Step your game up by increasing your reaction, control and focus with this portable sport rebound net.

Perfect for individual training or with teammates.

Convenient smaller size for indoor or outdoor use – take it to the beach or park for lots of fun.

Perfect model to get the little kids started towards a lifetime of healthy active fun.

US002 Upstart 2.0



CRAZYCATCH PROFESSIONAL 2.0

Large target area and heavy duty design makes the Original ideal for group use – at schools, sports clubs, or in the backyard for neighbourhood challenges! Great for practicing longer distance throwing and catching.

Our largest option, ideal for group activities. Perfect for Schools, Clubs and Families that have the space. Large rebound area, with heavy duty frame and components. Has Horizontal and vertical frame orientation. Both sane (predictable rebound) one side and insane (unpredictable rebound) on the other. Perfect for all age groups and skill levels.

1480mm(w) x 910mm(h)

Includes: Crazycatch level 2 vision Ball, Crazy catch timer, Activity pack with Scorecard and Throwing targets.

PRO20 Pro 2.0



CRAZYCATCH WILD CHILD 2.0

Ideal size for indoor or outdoor use and convenient to take to the beach or park. Features same heavy duty frame and components as the professional.

930mm(w) x 930mm(h)

The portable indoor/outdoor option for the developing and serious sportsperson has 30% more rebound area than the Upstart. Features both sane (predictable rebound) one side and insane (unpredictable rebound) on the other.

Includes: Crazycatch level 2 vision Ball, Crazy Catch Timer, Activity pack with Scorecard, Throwing targets and Carry bag.

WC002 Wild Child 2.0



ALLIANCE REBOUNDER

Made of heavy duty steel tube (powder coated). Adjustable angle positions to control the angle of returning ball, making it great training device for players. Used for both indoor and outdoor use and includes anti-marking floor guard. Suitable for training (including cricket). Comes fully assembled. Foldable side arms and horizontal uprights makes for easy carriage, storage and transport

Size: 1M x 1M

ARB001 Alliance Rebounder

RUGBY UNION BALLS



GILBERT BARBARIAN BALL

International Top Grade Ball

6100 Size: 5



GILBERT DIMENSION BALL

Match Ball

6101 Size: 5



GILBERT TRAINING BALL

Training Ball

6102 Size: 5

SIZING GUIDE	
AGE	BALL SIZE
8 Years	Size 2
7 - 9 Years	Size 3
10 - 12 Years	Size 4
13+ Years	Size 5



SCIMITAR BALL

100078 Size: 3

100079 Size: 5



GILBERT JUNIOR MIDI BALL

6103 Size: 4



GILBERT JUNIOR MIDI BALL

6104 Size: 3



GILBERT JUNIOR MID BALL

6105 Size: 2



GILBERT PASS DEVELOPER

Overweight ball to develop wrist strength and passing distance. Weight: Approximately 1kg. Size: 5

6106 Size: 5

RUGBY LEAGUE BALLS



STEEDEN SYMMETRY OFFICIAL NRL BALL

6110



STEEDEN INTERNATIONAL CLUB MATCH BALL

6112 Size 5



STEEDEN MOD BALL

6113 Size 4



HURRICANE LEAGUE BALL

H123 Size 5



TYPHOON LEAGUE BALL

61153 Size 3

61154 Size 4

61155 Size 5



STEEDEN CLASSIC TRAINER

6115 Modified

6116 Mini - Size 3



STEEDEN MINI LEAGUE BALL

6111 Mini



CARDBOARD CORNER POSTS

6128 Corner Post

TOUCH RUGBY BALLS



STEEDEN CLASSIC TOUCH

6120



STEEDEN MIGHTY TOUCH

6121



SG TOUCH BALL

Approved by Touch West

6123 Senior Ball

6124 Junior Ball



NITE FLURO TOUCH BALL

6126 Night Ball

AMERICAN FOOTBALLS



BADEN QB COMPOSITE FULL SIZE BALL

6129 Brown

6129 Black/Neon Green



BADEN QB COMPOSITE YOUTH BALL

6130 Youth



BADEN QB1 BUCKSKIN LEATHER NFHS FULL SIZE

100080



BADEN PERFECTION REDWOOD LEATHER FULL SIZE BALL

100081



BADEN QB1 COMPOSITE FULL SIZE BALL

100082



BADEN QB MOULDED RUBBER FULL SIZE BALL

100083 Size: 9

100084 Size: 6

100085 Size: 5



RUBBER MINI BALL

6131 Mini



WILSON MATCH LEATHER BALL

6132 Match Leather



FLEXI-SAFE CORNER POST SET

Flexible spring back poles for marking out your field while keeping player safety a priority. Heavy duty 30mm PVC pole with a 9cm rubber encased spring. 19cm plastic sleeve inserts into the ground. Includes carry bag for storage and transport. Sold as set of 4.

Pole is 135cm long and extends 120cm above ground.

9716

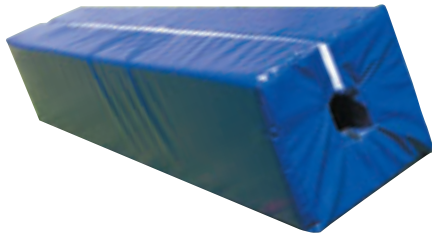

RUGBY POST PADDING

- Square post guard with cylindrical internal hole
- 125mm of foam either side of post
- Heavy duty nylon material with UV protective coating
- 1800mm High

4169W	White - 100mm Internal Hole.
4169R	Royal Blue - 100mm Internal Hole.
4170W	White - 120mm Internal Hole.



CUSTOM FOAM BOLSTER

- Vinyl cover with digital print graphics
- Foam centre making it a safe way to display signage
- Tab with reinforced eyelet to secure the bolsters to the ground

100012	50cm x 50cm x 50cm	Each
100013	100cm x 50cm x 50cm	Each
100014	150cm x 50cm x 50cm	Each
100015	200cm x 50cm x 50cm	Each
100016	300cm x 50cm x 50cm	Each



HEIGHT ADJUSTABLE KICKING TEE

6135



TOUCH FLAG BELT SET & FLAGS

6124R	A. Flag Belt Set - 1 Belt Plus 2 Flags - Red
6124B	A. Flag Belt Set - 1 Belt Plus 2 Flags - Blue
6124G	A. Flag Belt Set - 1 Belt Plus 2 Flags - Green
6124Y	A. Flag Belt Set - 1 Belt Plus 2 Flags - Yellow
6126R	Flag Only - Red
6126B	Flag Only - Blue
6126G	Flag Only - Green
6126Y	Flag Only - Yellow
6127	Belt Only
6125	B. Flag Belt Carry Pouch



STANDARD KICKING TEE

6136



GILBERT HEAD GUARD

6133



CANTERBURY HEAD GUARD

6134



CURVED LARGE BUMP PAD

- 5101R Red
- 5101B Royal Blue



STRAIGHT LARGE BUMP PAD

- 5106R Red
- 5106B Royal Blue
- 5106N Navy
- 5106Y Yellow



STRAIGHT XL BUMP PAD

- XLBPR Red
- XLBPB Royal Blue
- XLBPN Navy
- XLBPY Yellow



CURVED BUMP PAD

- 5105R Red
- 5105B Royal Blue
- 5105N Navy
- 5105Y Yellow



RUCK BAG XL

- 5108C Royal Blue
- FBTARXL03 Red



MOBILE RUCK BAG WITH LEDGE

- 5109R Red
- 5109B Royal Blue
- 5109N Navy



RUCK BAG WITH HANDLES

- RBWHR Red
- RBWHB Royal Blue



SQUARE BUMP PAD LARGE

- 5107R Red
- 5107B Royal Blue
- 5107N Navy
- 5107Y Yellow



FOREARM CURVED BUMP PAD

- 5100R Red
- 5100B Royal Blue
- 5100N Navy
- 5100Y Yellow



CONVEX BUMP PAD

5104R	Red
5104B	Royal Blue
5104N	Navy



CONCAVE BUMP PAD

5102R	Red
5102B	Royal Blue
5102N	Navy



DIAMOND PROTECTIVE SHIELD

5103R	Red
5103B	Royal Blue
5103N	Navy



MEDIUM TACKLING BAG

- Heavy duty vinyl cover
- High density foam core
- Reinforced suede handles

5112R	Red - 1200mm x 350mm
5112B	Royal Blue - 1200mm x 350mm
5112N	Navy - 1200mm x 350mm
5112Y	Yellow - 1200mm x 350mm



LARGE TACKLING BAG

- Heavy duty vinyl cover
- High density foam core
- Reinforced suede handles

5111R	Red - 1500mm x 400mm
5111B	Royal Blue - 1500mm x 400mm
5111N	Navy - 1500mm x 400mm
5111Y	Yellow - 1500mm x 400mm



EXTRA LARGE TACKLING BAG

- Heavy duty vinyl cover
- High density foam core
- Reinforced suede handles

5110R	Red - 1800mm x 450mm
5110B	Royal Blue - 1800mm x 450mm
5110N	Navy - 1800mm x 450mm
5110Y	Yellow - 1800mm x 450mm

Please visit www.slatergartrellsports.com.au for up to date pricing.

RUGBY / GRIDIRON

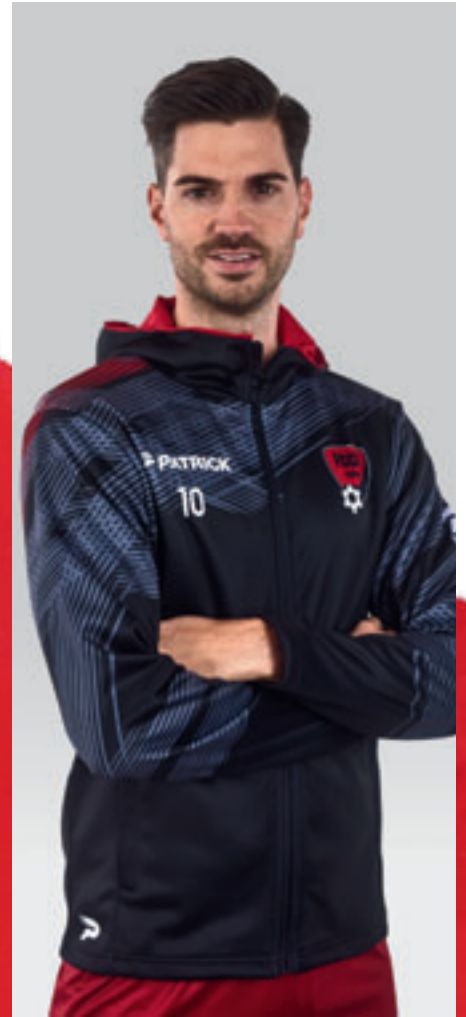

PATRICK

l'Esprit du sport
since 1892



footballs



shinguards



training equip.



PORTABLE GAMETIME SCOREBOARD

Is a versatile portable scoring, timekeeping and audio player system for your gaming event. From street-hockey in your driveway to a basketball match at the community center, you can play like the pros. Hear the GAMETIME SCOREBOARD sound effect generated stadium roar in the heat of the competition while blasting your favorite tunes with the MP3/Audio player. Battery powered and remote controlled, the GAMETIME SCOREBOARD is an essential piece of sporting equipment that enhances your game experience.

2029



ELECTRONIC LED SCOREBOARD MULTI-SPORT

- LED Scoreboard suitable for a multitude of sports
- Remote controller can be stored inside the back of scoreboard
- Rechargeable battery for up to 5 hours continuous use

2030



TENNIS SCOREBOARD

Two sided score board. Change the score on one side and it automatically changes the score on the other side. Easy to use. Lightweight to allow easy hanging on fence or umpire's chair. Numbers go up to 7 and are easily changed with the side wheels. Size: 65cm(H) x 46cm(W). Not suitable to be left outdoors permanently.

19310



MULTI SPORT FLIP OVER SCORE CHART

7050



PORTABLE DELUXE MULTI SPORT FLIP OVER SCOREBOARD

100039



CRICKET FLIP OVER SCOREBOARD

2833

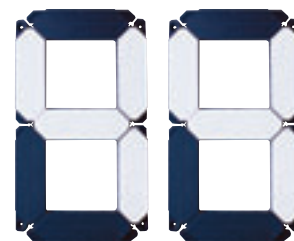

DIGITAL SCORE NUMBERS

2834 29cm (H) x 16cm (W)

Each

Please visit www.slatergartrellsports.com.au for up to date pricing.

OUTDOOR SOCCER BALLS

BALL SIZING GUIDE

AGE	BALL SIZE
7 - 9 Years	Size 3
10 - 13 Years	Size 4
14+ Years	Size 5

FIFA QUALITY



SELECT SUPER FIFA APPROVED

6200 Size: 5

FIFA QUALITY



SELECT MATCH FIFA APPROVED

SMAT Size: 5

FIFA QUALITY



SELECT TEAM FIFA APPROVED

62014 Size: 4
62015 Size: 5

FIFA INSPECTED



MITRE ULTIMATCH FIFA INSPECTED

6202 Size: 5

FIFA INSPECTED



SELECT CONTRA FIFA INSPECTED

62033 Size: 3
62034 Size: 4
62035 Size: 5

IMS APPROVED



SELECT SAMBA IMS APPROVED

Colours Available: White/Red, White/Black/Lime, White/Purple, Yellow/Navy, White/Blue.
62043 Size: 3
62044 Size: 4
62045 Size: 5



SELECT BRAZIL

Colours
Size 3: White/Orange
Size 4: White/Navy
Size 5: Black/White
SBSB1 Size: 3
SBSB2 Size: 4
SBSB5 Size: 5



PATRICK RUSH RECOMMENDED TRAINING

62053 Size: 3
62054 Size: 4
62055 Size: 5



PATRICK ATOMIC

62063 Size: 3
62064 Size: 4
62065 Size: 5



PATRICK BOCCA ELAN

62073 Size: 3
62074 Size: 4
62075 Size: 5



RUBBER SOCCER BALL

62603 Sizes: 3
62604 Sizes: 4
62605 Sizes: 5



GATOR SOCCER BALL TOUGH SKIN

62020

INDOOR / SYNTHETIC TURF SOCCER BALLS

BALL SIZING GUIDE

AGE	BALL SIZE
7 - 9 Years	Size 3
10 - 13 Years	Size 4
14+ Years	Size 5

HARD WEARING



SELECT FLASH TURF
SYNTHETIC TURF

6220 Size: 5



SELECT INDOOR SPEED

6221 Size: 5



SELECT TALENTO 13
TRAINING BALL

TAL01 Size: 3



NASSAU DELUXE INDOOR PRO

6222 Size: 4



PATRICK HEROICA INDOOR - FELT

SPBINH4 Size: 4

IMS APPROVED



SELECT FUTSAL MASTER

6224 Sizes: 4

IMS APPROVED



SELECT FUTSAL MIMAS

Colours Available: White/Blue/Orange, Yellow/Blue Orange.

6225 Sizes: 4

Available in two different colours.

IMS APPROVED



SELECT FUTSAL SAMBA

SFS01 Sizes: 4



ALLIANCE STANDARD INDOOR

6223 Size: 4



NERF FOAM SOCCER BALLS

6263 4" 100mm

6264 6" 150mm

6265 200mm



SELECT FUTSAL ATTACK

6226 Size: 4



PATRICK FUTSAL FUSION

6227 Size: 4



EQUIP FUTSAL

100086 Size: 4

100087 Size: 5

SOCCER BALLS

Please visit www.slatertrellsports.com.au for up to date pricing.

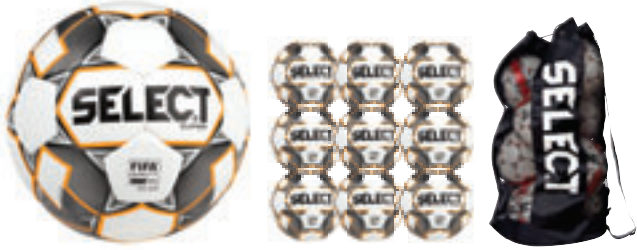

SUPER BALL PACK

Pack Includes:
**10 Super Match Balls,
 Pro Ball Bag and Valve Oil**

62405 Size: 5



MATCH BALL PACK

Pack Includes:
**10 Match Balls,
 Pro Ball Bag and Valve Oil**

MBP01 Size: 5



SAMBA BALL PACK

Pack Includes:
**10 Team Balls,
 Pro Ball Bag and Valve Oil**

SBP01 Size: 4

SBP02 Size: 5

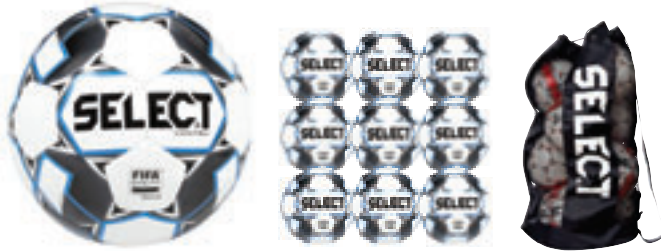

CONTRA BALL PACK

Pack Includes:
**10 Contra Match Balls,
 Pro Ball Bag and Valve Oil**

62433 Size: 3

62434 Size: 4

62435 Size: 5



MIMAS FUTSAL BALL PACK

Pack Includes:
**10 Mimas Futsal Y Balls,
 Pro Ball Bag and Valve Oil**

62462 Size: 2.5 (56-57cm)

62463 Size: 3.5 (62-64cm)

Also available in:
 White/Blue/Orange.



ATTACK FUTSAL BALL PACK

Pack Includes:
**10 Attack Futsal Balls,
 Pro Ball Bag and Valve Oil**

62464 Size: 4



PRESSURE GAUGE & VALVE OIL

6266 Pressure Gauge
6268 Valve Oil



BALL CARE PACK

6289



MICRO BALL PUMP

6267



BALL PUMP WITH BICYCLE ATTACHMENT

SBP001



STRING BAGS

2033 Large - Holds 14 Basketballs
2034 Medium - Holds 8 Basketballs
2035 Small



SELECT DELUXE BAG WITH PVC BASE

6269S Small (Holds 4-5 Balls)
6269M Medium (Holds 10-12 Balls)
6269 Large (Holds 16-18 Balls)



VELCRO NET PEGS & STRAPS

6273 A: Pack of 10 Net Pegs with Bag
6272 B: Pack of 15 Velcro Net Ties



SOCCER NETS PER PAIR

6270 Standard Orange Net **Pair**
6274 Deluxe White **Pair**
6271 International White Box Style **Pair**



PATRICK MATCH TUBE BALL BAG

30154 Holds 3 Balls
30155 Holds 5 Balls



PATRICK DELUXE BAG WITH PVC BASE

2032 Black
2032R Red
2032RB Royal Blue
2032NB Navy
2032FY Fluro Yellow
2032FO Fluro Orange



PATRICK METAL SOCCER NET PEGS PACK OF 20

Metal Spikes. Supplied in handy carry pouch.

100051



SG POP UP GOALS

4521

Pair

SENIOR GLOVES



**GLOVE 77
PRO ROLL FINGER**

Type: Professional match glove
 Backhand: 3 mm Deep Embossed Soft Latex provides a soft and flexible glove.
 Palm: 3 mm Soft Contact Latex for perfect grip in all kinds of weather.
 Fit: The Anatomical Fit System ensures optimum fit as the glove is designed according to the hand's natural grip position.
 Cut: Roll Finger Cut.
 Wrist: A wide latex strap provides greater support to the wrist and ensures quick, easy and correct adjustment.
 Size: 8-9-10

6296	Size: 8
6297	Size: 9
6298	Size: 10



**GLOVE 34
FINGER PROTEK**

Type: Training glove
 Palm: 3 mm Dura Grip Latex ensures good grip and durability.
 Protection: Fixed guards for reinforcement and protection of the fingers.
 Fit: The Anatomical Fit System ensures optimum fit as the glove is designed according to the hand's natural grip position.
 Cut: Flat Cut
 Wrist: A wide latex strap provides greater support to the wrist and ensures quick, easy and correct adjustment.
 Size: 7-8-9-10-11

6301	Size: 7
6302	Size: 8
6303	Size: 9
6304	Size: 10
6305	Size: 11



**GLOVE 33
LIGA FUTSAL**

Type: Training and match glove
 Palm: 3 mm Dura Grip Latex ensures good grip and durability.
 Fit: The fingertips are free in order to provide optimum ball control at the start of the game.
 Cut: Flat Cut.
 Wrist: A wide latex strap provides greater support to the wrist and ensures quick, easy and correct adjustment.
 Size: 7-8-9-10

6306	Size: 7
6307	Size: 8
6308	Size: 9
6309	Size: 10

JUNIOR GLOVES



**GLOVE 88
PRO FLAT**

Type: Training and match glove for children
 Palm: 3 mm Ultra Pro Latex ensures a perfect grip in all kinds of weather.
 Ventilation: The fingers have mesh on the sides which ensures good air circulation.
 Fit: The Anatomical Fit System ensures optimum fit as the glove is designed according to the hand's natural grip position. Cut: Flat Cut
 Wrist: The slit-like wrist closure makes putting on the glove easy and provides good freedom of movement.
 Size: 5-6-7

6311	Size: 5
6312	Size: 6
6313	Size: 7



**GLOVE 04
FINGER PROTEK**

Type: Training and match glove for children
 Palm: 3 mm Flexion Latex ensures a perfect grip in all kinds of weather.
 Protection: Fixed guards for reinforcement and protection of the fingers.
 Ventilation: The fingers have mesh on the sides which ensures good air circulation.
 Fit: The Anatomical Fit System ensures optimum fit as the glove is designed according to the hand's natural grip position.
 Cut: Flat Cut.
 Wrist: The slit-like wrist closure makes putting on the glove easy and provides good freedom of movement.

6314	Size: 4
6315	Size: 5
6316	Size: 6
6317	Size: 7



**GLOVE 03
FLAT CUT**

Type: Training and match glove for children
 Palm: 3 mm Flexion Latex ensures a perfect grip in all kinds of weather. Ventilation:
 The fingers have mesh on the sides which ensures good air circulation.
 Fit: The Anatomical Fit System ensures optimum fit as the glove is designed according to the hand's natural grip position.
 Cut: Flat Cut
 Wrist: The slit-like wrist closure makes putting on the glove easy and provides good freedom of movement.
 Size: 4-5-6

6318	Size: 4
6319	Size: 5
6320	Size: 6



HO GOAL KEEPING GLOVE CLONE PRIMERO FLAT

PALM: 3mm HARDSOFT latex + 3mm of foam
 PALM/STYLE CUT: Traditional flat cut
 BACK/BODY: Grid body, light and flexible
 BACKHAND: 5mm PU with details on relief
 WRIST CLOSURE: Wristband of 7cm and belt with 3 velcro fastenings
 Colour: Fluoro Yellow/Black/Blue

100087H	Size: 3
100088	Size: 4
100089	Size: 5
100090	Size: 6
100091	Size: 7
100092	Size: 8
100093	Size: 9
100094	Size: 10



HO BASIC PROTEK GOAL KEEPING GLOVES

PALM: 4mm of synthetic lime DURAGRAIP + 2mm of foam.
 PALM STYLE/CUT: Traditional flat cut
 BACKHAND: Synthetic DURAGRIP latex of 5mm
 FPS: Finger protection system of 5 anatomical protection rods on the back of the hand.
 BACKHAND COLOUR: Fluoro Yellow, Black and Silver
 WRIST CLOSURE: Wristband of 7cm and belt with 3 fastenings.

100100	Size: 5
100101	Size: 6
100102	Size: 7
100103	Size: 8
100104	Size: 9
100105	Size: 10



A



B

PASSING ARCHES & SPEED RINGS

6281	Passing Arches - Set of 4
6282	Speed Rings 40cm - Set of 8



COMPRESSOR HEAVY DUTY

4243	Compressor
4245	Replacement Compressor Hose



HO GOAL KEEPING GLOVE LEGEND ONE FLAT

PALM: 4mm UCG latex + 3mm of foam
 PALM/STYLE CUT: Traditional flat cut
 BACK/BODY: Very lightweight, flexible and breathable grid
 BACKHAND: Synthetic latex of 4mm, very soft and comfortable with embossing design improving the natural motion of the hand
 WRIST CLOSURE: Elastic wristband of 7cm and belt with 3 velcro fastenings
 Colour: Black/Red/White

100095	Size: 6
100096	Size: 7
100097	Size: 8
100098	Size: 9
100099	Size: 10



MULTI BALL INFLATION DEVICE

Inflate up to 11 balls at the one time with this innovative multi ball inflation device.

Note: Balls not included.

MBID01



INFLATOR NEEDLES

4250	Thick
4251	Thin



SUPER CUP PATRICK

6277XS	Size: XS - Colour: Black
6277S	Size: Small - Colour: Black
6277M	Size: Medium - Colour: Black
6277L	Size: Large - Colour: Black
6277XSW	Size: XS - Colour: White
6277SW	Size: Small - Colour: White
6277MW	Size: Medium - Colour: White
6277LW	Size: Large - Colour: White



STANDARD SELECT

- Front: Hot Stamp Foiling
- Backing: Plain EVA
- Packing: OPP Bag

6293XS	XS
6293S	Small
6293M	Medium
6293L	Large



CLUB PRO SELECT

- Front: Printed PPCP shell
- Backing: EVA Laminated with Polyester Fabric
- Closure: Top back closure
- Ankle sock: Stitched ankle sock
- Packaging: OPP Bag

6290XS	XS
6290S	Small
6290M	Medium
6290L	Large



PATRICK ATOMIC

6279XS	Size: XS - Colour: White
6279S	Size: Small - Colour: White
6279M	Size: Medium - Colour: White
6279L	Size: Large - Colour: White
6279XSK	Size: XS - Colour: Black
6279SK	Size: Small - Colour: Black
6279MK	Size: Medium - Colour: Black
6279LK	Size: Large - Colour: Black



FORCE PLUS SELECT

- Front: Printed PPCP shell
- Backing : EVA Laminated with Polyester Fabric
- Closure : Top back closure
- Ankle sock : Printed Detachable ankle sock with Plastic discs

SFPXS	XS
SFPS	Small
SFPM	Medium
SFPL	Large



PATRICK SOCK TIES

- Patrick Sock Ties used to keep shin guards up.
- Velcro fasteners designed to make adjusting size easy.
- Stops shin guards from slipping keeping shin guards up.
- Recommended to wear them below or at the base of shinguards to prevent from slipping.

PST01Y	Yellow
PST01SB	Sky Blue
PST01BG	Bottle Green
PST01M	Maroon
PST01E	Emerald
PST01O	Orange



DIAMOND PRO CORNER POST SET

- Dimensions: Height: 165cm, Diameter of pole: 30mm
- Materials: Plastic with plastic ground housings, metal entrenching tool and nylon flags
- 4 poles, flags and ground housings
- Outdoor Use Only
- This set comes an entrenching tool and 4 ground housings for the poles to fit into

100111



DIAMOND RESPECT BARRIER

- Sizes Available: 60M & 100M
- 28mm diameter pole, 30inches in height above ground
- Materials: Plastic poles with spikes and nylon webbing
- Sized to accompany 7 or 11 aside football pitch.
- Easy fix posts 1m high complete with a carry bag and a reel of webbing
- Outdoor Use

DRSB01	60m
DRSB02	100m



NET CLIPS

100112 30 Pack



**FREE
KICK!**

FREE KICK MAN

Spiked base for use on a grass surface. Does not include the base for use on hard ground.

6283

**BASE FOR
FREE KICK MAN**

For use on hard ground.

6284



**FREE KICK MAN
CARRY BAG - HOLDS 5**

Great quality polyester polyester carry bag. Designed to hold up to 5 Free Kick Man (Mannequin). Has shoulder strap for easy transport

100052



**PATRICK CORNER POST
SET OF 4 - 1 PC POLES**

100054



**PATRICK CORNER POST
SET DELUXE - 2PC POLES
WITH SPRINGS**

6279



**WARNING CARDS SET
IN PVC WALLET
WITH COIN**

100053



LINESMAN FLAGS

6286

Pair

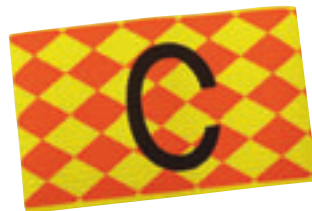

CAPTAINS ARM BAND

6287



**WARNING CARDS
IN PVC WALLET**

6288

Please visit www.slatergartrellsports.com.au for up to date pricing.

SOCCER



**PATRICK
CALPE GOAL KEEPING SHIRT**

GK003	Small - Orange
GK004	Medium - Orange
GK005	Large - Orange
GK010	Small - Green
GK012	Medium - Green
GK013	Large - Green
GK018	Small - Yellow
GK019	Medium - Yellow
GK020	Large - Yellow
GK025	Small - Red
GK026	Medium - Red
GK027	Large - Red



**SELECT
BRAZIL GOAL KEEPING SHIRT DELUXE**

30156	6 - Orange/Black
30157	8 - Orange/Black
30158	10 - Orange/Black
30159	12 - Orange/Black
30160	XS - Orange/Black
30161	S - Orange/Black
30162	M - Orange/Black
30163	L - Orange/Black
30164	XL - Orange/Black
30165	2XL - Orange/Black
30166	6 - Grey/Black
30167	8 - Grey/Black
30168	10 - Grey/Black
30169	12 - Grey/Black
30170	XS - Grey/Black
30171	S - Grey/Black
30172	M - Grey/Black
30173	L - Grey/Black
30174	XL - Grey/Black
30175	2XL - Grey/Black
30176	6 - Green/Black
30177	8 - Green/Black
30178	10 - Green/Black
30179	12 - Green/Black
30180	XS - Green/Black
30181	S - Green/Black
30182	M - Green/Black
30183	L - Green/Black
30184	XL - Green/Black
30185	2XL - Green/Black



TRAINING SINGLET SG PRO

Airflow mesh material for superior cool comfort. Reinforced seams for durability.

2004XS	XS Yellow
2004XSB	XS Royal Blue
2004XSR	XS Red
2004XSW	XS White
2004XSBG	XS Bright Green
2004XSBO	XS Bright Orange
2004XSK	XS Black
2004XSP	XS Pink
2004SY	Small Yellow
2004SB	Small Royal Blue
2004SR	Small Red
2004SW	Small White
2004SBG	Small Bright Green
2004SBO	Small Bright Orange
2004SK	Small Black
2004SP	Small Pink
2004MY	Medium Yellow
2004MB	Medium Royal Blue
2004MR	Medium Red
2004MW	Medium White
2004MBG	Medium Bright Green
2004MBO	Medium Bright Orange
2004MK	Medium Black
2004MP	Medium Pink
2004LY	Large Yellow
2004LB	Large Royal Blue
2004LR	Large Red
2004LW	Large White
2004LBG	Large Bright Green
2004LBO	Large Bright Orange
2004LK	Large Black
2004LP	Large Pink
2004XLY	XL Yellow
2004XLB	XL Royal Blue
2004XLR	XL Red
2004XLW	XL White
2004XLBG	XL Bright Green
2004XLBO	XL Bright Orange
2004XLK	XL Black
2004XLP	XL Pink



PATRICK NUMBERED SINGLETS

Flow-through nylon basketball singlet style mesh bib. Set of 10 or 15.

2012YS	Yellow Set of 10 - No.1-10 Small
2012OS	Orange Set of 10 - No.1-10 Small
2012BS	Blue Set of 10 - No.1-10 Small
2012GS	Green Set of 10 - No.1-10 Small
2012YM	Yellow Set of 10 - No.1-10 Medium
2012OM	Orange Set of 10 - No.1-10 Medium
2012BM	Blue Set of 10 - No.1-10 Medium
2012GM	Green Set of 10 - No.1-10 Medium
2012YL	Yellow Set of 10 - No.1-10 Large
2012OL	Orange Set of 10 - No.1-10 Large
2012BL	Blue Set of 10 - No.1-10 Large
2012GL	Green Set of 10 - No.1-10 Large
2013YS	Yellow Set of 5 - No.11-15 Small
2013OS	Orange Set of 5 - No.11-15 Small
2013BS	Blue Set of 5 - No.11-15 Small
2013GS	Green Set of 5 - No.11-15 Small
2013YM	Yellow Set of 5 - No.11-15 Medium
2013OM	Orange Set of 5 - No.11-15 Medium
2013BM	Blue Set of 5 - No.11-15 Medium
2013GM	Green Set of 5 - No.11-15 Medium
2013YL	Yellow Set of 5 - No.11-15 Large
2013OL	Orange Set of 5 - No.11-15 Large
2013BL	Blue Set of 5 - No.11-15 Large
2013GL	Green Set of 5 - No.11-15 Large
2014YS	Yellow Set of 5 - No.16-20 Small
2014OS	Orange Set of 5 - No.16-20 Small
2014BS	Blue Set of 5 - No.16-20 Small
2014GS	Green Set of 5 - No.16-20 Small
2014YM	Yellow Set of 5 - No.16-20 Medium
2014OM	Orange Set of 5 - No.16-20 Medium
2014BM	Blue Set of 5 - No.16-20 Medium
2014GM	Green Set of 5 - No.16-20 Medium
2014YL	Yellow Set of 5 - No.16-20 Large
2014OL	Orange Set of 5 - No.16-20 Large
2014BL	Blue Set of 5 - No.16-20 Large
2014GL	Green Set of 5 - No.16-20 Large
2015YS	Yellow Set of 5 - No. 21-25 Small
2015OS	Orange Set of 5 - No.21-25 Small
2015BS	Blue Set of 5 - No.21-25 Small
2015GS	Green Set of 5 - No.21-25 Small
2015YM	Yellow Set of 5 - No. 21-25 Medium
2015OM	Orange Set of 5 - No.21-25 Medium
2015BM	Blue Set of 5 - No.21-25 Medium
2015GM	Green Set of 5 - No.21-25 Medium
2015YL	Yellow Set of 5 - No. 21-25 Large
2015OL	Orange Set of 5 - No.21-25 Large
2015BL	Blue Set of 5 - No.21-25 Large
2015GL	Green Set of 5 - No.21-25 Large



REVERSIBLE TRAINING SINGLETS

Breathable nylon mesh material. Can be worn with either colour outside to easily identify team members. Reinforced seams.

2011YRXXS	Yellow/Red - XXS
2011YRXS	Yellow/Red - XS
2011YRS	Yellow/Red - Small
2011YRM	Yellow/Red - Medium
2011YRL	Yellow/Red - Large
2011YRXL	Yellow/Red - XL
2011BPXXS	Black/Pink - XXS
2011BPXS	Black/Pink - XS
2011BPS	Black/Pink - Small
2011BPM	Black/Pink - Medium
2011BPL	Black/Pink - Large
2011BPXL	Black/Pink - XL
2011RSXXS	Royal/Sky - XXS
2011RSXS	Royal/Sky - XS
2011RSS	Royal/Sky - Small
2011RSM	Royal/Sky - Medium
2011RSL	Royal/Sky - Large
2011RSXL	Royal/Sky - XL
2011OGXXS	Orange/Green - XXS
2011OGXS	Orange/Green - XS
2011OGS	Orange/Green - Small
2011OGM	Orange/Green - Medium
2011OGL	Orange/Green - Large
2011OGL	Orange/Green - XL



PLAIN POLYESTER BIBS

2004W	White
2004K	Black
2004R	Red
2004RB	Royal
2004Y	Yellow
2004SKY	Sky Blue
2004M	Maroon
2004E	Emerald
2004P	Pink
2004BG	Bottle
2004PU	Purple
2004FO	Fluro Orange
2004FG	Fluro Green
2004NB	Navy Blue



MODCROSSE STX DELUXE KIT

6420 Modcrosse Starter Kit - 12 Sticks, Bag & 6 balls



SOFCROSSE DELUXE

6400YG A. Deluxe Set - 12 sticks & 6 balls (Y & G or B & R)
 6400BR A. Deluxe Set - 12 sticks & 6 balls (Blue & Red)



SOFCROSSE

6401	SG Sofcrosse Set - 12 sticks & 6 balls (Blue & Red)
6405	A. Sofcrosse Ball
GASCBL	B. Sofcrosse Ball
6406	Kusel Lacrosse Ball
6407	C. Straps Spare
6408	D. End Caps Spare
6409	Sofcrosse Bags
6410	Modcrosse Ball STX Deluxe
30186	Modcrosse Ball SG Standard Yellow



MODCROSSE CLASS SET

A excellent starter kit for schools and beginner programs.

- 24 x Warrior Warp Mini lacrosse sticks
- 24 x low compression tennis balls
- 2 x lacrosse stick bags
- 2 x lacrosse ball bags

Note: The Price shown does not include freight.
 The product will be sent for the Eastern States.

30187



MODCROSSE TEAM SET

A starter kit for Modcrosse or Under 11 lacrosse.

- 12 x U11 lacrosse sticks
- 12 x Modcrosse balls
- 1 x Heavy Duty Lacrosse Stick Bag
- 1 x Lacrosse Ball Bag

Note: The Price shown does not include freight.
The product will be sent for the Eastern States.

30211

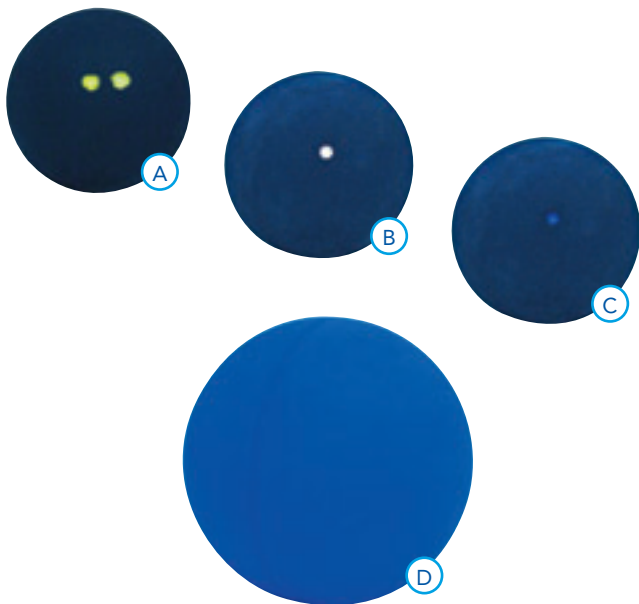

SQUASH BALLS

- | | |
|------|---|
| 6460 | A. Double Yellow Dot - PRO - Extra Super Slow Speed |
| 6461 | Yellow Dot - CHAMPIONSHIP - Super Slow Speed |
| 6462 | B. White Dot - TOURNAMENT - Slow Speed |
| 6463 | Red Dot - RECREATIONAL - Medium Speed |
| 6464 | C. Blue Dot - BEGINNER - Fast Speed |
| 6465 | D. Racquet balls can of Two |



SOFCROSSE STICK DELUXE

These Deluxe Sofcrosse Sticks are ideal for juniors. They are light weight with a collapsible soft plastic head. A good entry level stick to learn and develop the basics.

Specifications:

- High quality flexible ABS plastic head
- Aluminium shaft
- Perfect for schools and practice
- Made in Taiwan
- Size: 76cm

GASCSD03 SOFCROSSE STICK DELUXE - RED

GASCSD04 SOFCROSSE STICK DELUXE - BLUE



SQUASH & RACQUET BALL RACQUETS

- | | |
|------|--------------------------------|
| 6450 | A. SG Aluminium |
| 6451 | B. Deluxe Wide Body - Graphite |
| 6452 | Racquet Ball Racquets |

SQUASH ACCESSORIES

- | | |
|------|-----------------------|
| 6466 | Racquet Bumper Tape |
| 6477 | Squash Safety Glasses |



FUN SPEEDER

The FUN Speeder™, with its red skirt, is the lightest of all Speeder™ types. It is the perfect beginner Speeder™, suitable for children and training purposes.

SPEED005	Fun Speeder	Each
SPEED006	Fun Speeder 5	5 Pack
SPEED007	Wind Ring	Each



CROSS SPEEDER

The CROSS Speeder™, with its heavier weight, makes it perfect for playing outdoors, in particular. The increased weight also makes it fast over long distances.

SPEED001	Cross Speeder	Each
SPEED002	Cross Speeder	5 Pack
SPEED007	Wind Ring	Each



MATCH SPEEDER

The MATCH Speeder™ is the official tournament shuttle of the International Crossminton Organization (ICO) and used by all competitive players. Due to its weight the Speeder™ is very fast and guarantees spectacular rallies.

SPEED003	Match Speeder	Each
SPEED004	Match Speeder	5 Pack
SPEED007	Wind Ring	Each



JUNIOR FUN SPEEDMINTON RACKET

The Speedminton® FUN provides ultimate fun for family and friends and can be played anytime and anywhere - no net, no court necessary.

SPEED008	Fun Racket	Each
----------	------------	------



SCHOOL ALUMINIUM SPEEDMINTON RACKET

The Speedminton® SCHOOL ALU is a great value introduction to the world of Speedminton.

SPEED009	School Racket	Each
----------	---------------	------



EASY COURT PRO SPEEDMINTON

- Portable court for badminton matches
- Made out of durable nylon
- Simple and quick to set up
- Comes with 8 stakes, 2 straps and nylon carry bag to easy carrying

SPEED010	Fun Racket	Each
----------	------------	------



8 RACKET SPEEDMINTON SETS

Includes: 8 x Rackets, 8 x Speeders, 8 x Wind Rings, 2 Easy Court Pro & 1 Speedminton Bag.

SPEED011	Junior Set of 8	Set
SPEED012	School Set of 8	Set



16 RACKET SPEEDMINTON SETS

Includes: 16 x Rackets, 16 x Speeders, 16 x Wind Rings, 2 Easy Court Pro & 1 Speedminton Bag.

SPEED013	Junior Set of 16	Set
SPEED014	School Set of 16	Set



30 RACKET SPEEDMINTON SETS

Includes: 30 x Rackets, 30 x Speeders, 30 x Wind Rings, 2 Easy Court Pro & 2 Speedminton Bags.

SPEED015	Junior Set of 30	Set
SPEED016	School Set of 30	Set



SG 1000 BASIC

6502 Single Lap



SG 2000 - 10 LAP

6501 10 Lap Memory



SG 3000 - 100 LAP

6500 100 Lap Memory



LEEDA 100 LAP S/F

6503 100 Lap - Stroke Frequency



DT800 MULTI LANE TIMER

6511 8000 Memory



DT800 WIRELESS RECEIVER

6512



DT800 MULTI LANE TIMER WIRELESS BUTTON

6513



DT800 PRINTER PAPER

6514 Single Roll

6510 Pack of 5



SEIKO SYSTEM STOP WATCH WITH BUILT IN PRINTER

6515



BATTERIES

6504 Small Battery (LR44)

6505 Large Battery (CR2032)

OTHER STOP WATCHES AND ACCESSORIES

6507 DT 2000 Lap Memory

6508 DT 500 Lap Memory

6516 Seiko Thermal Paper (Pack of 5)

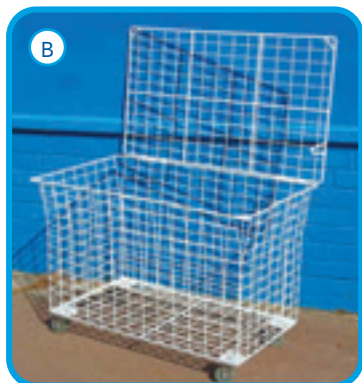

STORAGE BASKET / TROLLEY

- 6520 **A.** Storage Basket white Wire Mesh 750Hx510Wx510L
- 6521 **B.** Storage Trolley on Wheels White with lid 600Hx600Wx1000L
- 6522 Storage Trolley on Wheels White NO LID 600Hx600Wx1000L
- 6523 Storage Trolley with 2 Dividers
- 6524 Storage Trolley Lid Only



HIGH JUMP MAT TROLLEY

1213 1800 x 1200 x 457mm



WHEELIE BINS

- 6550 120 Litre - Green
- 6551Y 120 Litre - Yellow
- 6551R 120 Litre - Red
- 6551B 120 Litre - Blue
- 6551O 120 Litre - Orange
- 6551M 120 Litre - Maroon
- 6552 240 Litre - Green
- 6553Y 240 Litre - Yellow
- 6553R 240 Litre - Red
- 6553B 240 Litre - Blue
- 6553O 240 Litre - Orange
- 6553M 240 Litre - Maroon
- 6555 360 Litre - Green Only

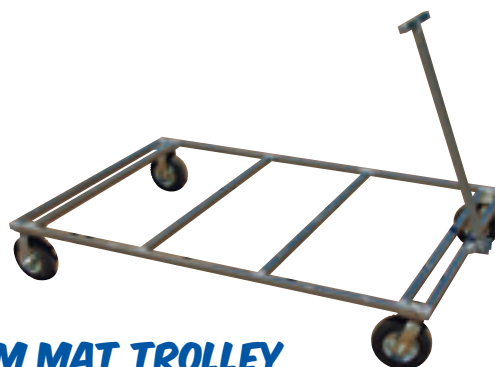

GYM MAT TROLLEY

5605 1800 x 1200 x 457mm



DISCUS TROLLEY

Solid heavy duty metal construction. Rubber tyres. Holds up to 36 discus and is very easy to manoeuvre. 1.4m long approximatly.

1178



SHOT PUT TROLLEY

Durable 15cm rubber wheels. Easy to turn using handle. Holds 15 shot puts

1177



JAVELIN STORAGE TROLLEY

Javelin Storage Trolley with durable 15cm rubber wheels. Holds up to 18 Javelins and has a easy to turn swivel handle.

1355



SPORTS STORAGE CART

960mm x 510mm x 255mm
6554



EQUIPMENT TROLLEY

1200mm x 850mm x 600mm
5604



STORAGE CAGE

1200mm x 800mm x 800mm
5606



SG STORAGE BAG

2931 90cm Storage Bag
100145 60cm Storage Bag



METAL MESH BALL STORAGE CAGE - FOLDABLE

Holds approximately 25 size 5 balls.
(L)910mm x (W)630mm x (H)930mm approximately.
2014



STRING BAGS

2033 Large - Holds 14 Basketballs
2034 Medium - Holds 8 Basketballs
2035 Small



FINE MESH CARRY BAGS

Strong Polyester Mesh-Great Bag to Air Out Your Wet Gear. 68 x 52cm

2011 Black Fine Mesh Carry Bag
2012 Blue Fine Mesh Carry Bag
2013 Red Fine Mesh Carry Bag



STACKABLE TUBS & TOTES

6560 A. 68 litre 645 x 413 x 397mm
6561 46 litre 655 x 413 x 275mm
6562 B. 32 litre 645 x 413 x 210mm
6563 Lid for the three tubs listed above
6564 C. Storage Bucket 20 litre
6565 Storage Bucket 5 litre
6566 D. Basket with Handles 260Hx320Wx470L
6567 E. SG Ball Tote on Wheels
6567M F. Molten Ball Tote on Wheels

PATRICK DELUXE BAG WITH PVC BASE

2032

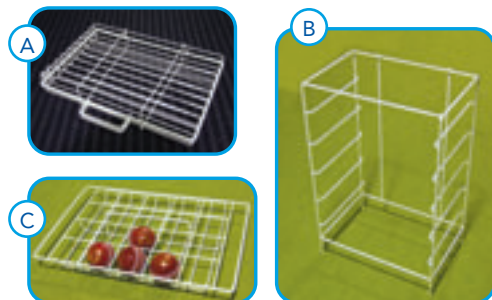

BALL CAGE

5221 A. Ball cage 24 Cricket, Baseball, hockey. 9"
6570 Ball cage 15 Softball. 12"
6571 B. Storage Unit Holds 5 trays
6572 C. Storage Unit Tray Cricket / Softball



**DRY TOUCH SPF50+
SUNSCREEN LOTION 50G**

4hrs Water Resistant. Non-Greasy.

MB001



**DRY TOUCH SPF50+
SUNSCREEN LOTION 100G**

4hrs Water Resistant. Non-Greasy.

MB002



**DRY TOUCH SPF50+
SUNSCREEN LOTION 200G**

4hrs Water Resistant. Non-Greasy.

MB003



**DRY TOUCH SPF50+
SUNSCREEN LOTION 500ML**

4hrs Water Resistant. Non-Greasy.

MB004



**DRY TOUCH SPF50+
SUNSCREEN LOTION 1L**

4hrs Water Resistant. Non-Greasy.

MB005



**EVERY DAY TRIGGER
SUNSCREEN SPRAY 250ML**

4hrs Water Resistant. Non-Greasy.

MB006



**ULTRA SPF50+
SUNSCREEN LOTION 100G**

Very High Protection. 4hrs Water Resistant.

MB007



**ULTRA SPF50+
SUNSCREEN LOTION 200G**

Very High Protection. 4hrs Water Resistant.

MB008



**KIDS SPF50+
SUNSCREEN TUBE 200G**

Very High Protection. 4hrs Water Resistant.

MB009



**LIP BALM SPF50+
STICK 5G**

Contains Vitamin E & Skin Soothing Aloe Vera.

MB010



**FACES SPF50+
SUNSCREEN LOTION 75G**

Oil Free & Fragrance Free.

MB011



**ALOE VERA AFTER SUN
BODY GEL TUBE 200G**

Soothes, Moisturizes & Cools the Skin.

MB012

Z-RAY STAND UP PADDLE BOARDS

ZRAY Inflatable Stand Up Boards (AKA iSUP) provide a simple and convenient way to get out onto the water and go paddling. ZRAY SUPs offer great versatility, stability, portability, durability and incredible rigidity... seriously, they are as stiff as a board! Not only are ZRAY SUPs fantastic quality, they are the best value for money inflatable SUPs you'll find in Australia - just try and find a better product for the price... we'll wait!

Our most popular boards include the entry level E10 All Round Multiboard and Premium series A1 & A2 Touring SUPs, R1 and R2 Racing SUPs.

ZRAY SUPs are available in packages that include a 3 piece paddle, pump and carry bag. There are various models to choose from, including touring and racing styled boards in a premium series constructed with Dual Layer 'Duplex Rigid Heavy Duty' (DRHD) Technology as well as a budget friendly recreational board built using Zray's Single Layer 'Ultimate Agile Light Technology' (UAL)



X1 SUP: ALL AROUND MULTIBOARD SUP

SUPDude Australia offers the very successful ALL AROUND COLLECTION - it is great for a variety of water conditions. Very stable and maneuverable with excellent glide characteristics. These multi-purpose paddle boards are perfect for learning and progressing.

Package include: Adjustable paddle, high-pressure pump with gauge, durable SUP backpack.

X1SUP



A4 SUP: PREMIUM TOURING BOARD FOR LONG DISTANCES

IDEAL TOURING iSUP - At 11'6" this Z-Ray board is designed for maneuverability and control with 3 fins and an ultra-stable 32" width. Perfect for touring lakes or rivers even in slightly rough waters

GREAT FOR BEGINNERS - With its ultra-stable 32" width, this board is easy for anyone to balance on. Can support up to 352 lbs.

SET INCLUDES - SUP, a footrest, a backpack, an adjustable aluminum paddle (65-85 inches), a high pressure hand pump and a closing belt to keep the board rolled up in the backpack

A4SUP



K8 INFLATABLE STAND UP PADDLE BOARD 8' FOR YOUNGSTERS

For kids and teenagers to learn SUP Basics. Safe, stable and easy to paddle. Deliver the maximum fun to the younger generation. Designed for kids and teenagers with bright colours. Due to the shorter length and width it is easier for young riders to maneuver. Lightweight to carry. Quick and easy to inflate.

Package include: Ankle leash, Aluminum paddle, high-pressure pump with gauge, Durable SUP backpack.

K8SUP



A2 10'6 SUP PREMIUM TOURING BOARD

SUPDude Australia recommends the A2 10'6 Premium Touring Board for long distance touring experiences. These premium boards have a double layer construction combined with a casual look. It is easy to maneuver and adjust in various water conditions. Suitable for all skill levels.

Package include: Adjustable paddle, closing belt, high pressure pump with gauge, footrest, durable SUP backpack.

A2SUP



S17 SUPER SERIES SUP GIANT BOARD

This giant paddle board was specifically designed for a bigger group of paddlers. SUPDude Australia recommends using this board for team buildings, birthday parties, group parties, family bonding and just for having fun. Space for up to 8 riders. Suitable for all level riders. Quick and easy inflation with 4 valves. Super wide deck and tail. 17'x60x8 makes the board extremely durable and stable

S17SUP



SWIMMING CAPS



Latex Swim Caps

6600 White	6601 Yellow	6602 Red	6603 Green	6604 Blue
6605 Powder Blue	6606 Black	6607 Navy	6608 Purple	6609 Daglo Green
6610 Daglo Orange	6611 Daglo Yellow	6612 Daglo Pink	6613 Orange	6614 Maroon



Silicone Swim Caps

6620 Aqua	6621 Mid Blue	6622 Mid Green	6623 Petal Pink	6624 Lilac
6625 Key Lime	6626 Maroon	6627 Neon Orange	6628 Neon Pink	6629 White
6630 Purple	6631 Black	6632 Silver	6633 Mint Green	6634 Metal Blue
6635 Metal Green	6636 Navy	6637 Red	6638 Powder Blue	6639 Buttercup Yellow

CUSTOM PRINTED SWIM CAPS

Custom Printed Swim Caps are available **POA**

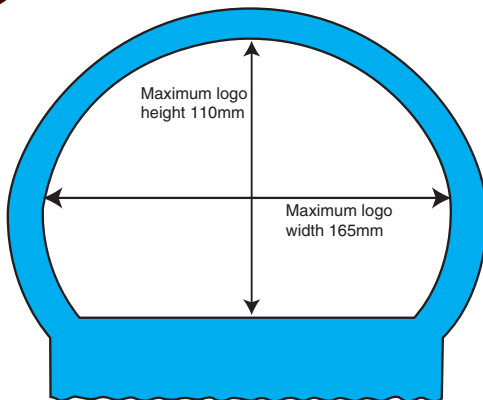

Available colours for Custom Printed Latex Cap 6650

White	Yellow	Red	Green	Blue
Powder Blue	Black	Navy	Purple	Daglo Green
Daglo Orange	Daglo Yellow	Daglo Pink	Orange	Maroon

Available colours for Custom Printed Silicone Cap 6655

White	Black	Red	Mint Green	Metal Blue
Metal Green	Navy	Powder Blue	Silver	Purple
Buttercup Yellow	Neon Orange	Neon Pink		

Colours indicated are as close as possible using the four colour process.

FLIPPERS

6660	Size 8-11 C
6661	Size 11-13 C
6662	Size 1-3
6663	Size 3-5
6664	Size 5-7
6665	Size 7-9
6666	Size 9-11
6667	Size 11-13
6668	Size 13-15



FINE MESH CARRY BAGS

Strong Polyester Mesh-Great Bag to Air Out Your Wet Gear. 68 x 52cm

2011	Black Fine Mesh Carry Bag
2012	Blue Fine Mesh Carry Bag
2013	Red Fine Mesh Carry Bag



SWIMFIT SILICONE TRAINING FINS BLACK/AQUA

Made from 100% silicone for comfort and added durability.

SFFS2S	Small 13J-3
SFFS2M	Medium 4-6
SFFS2L	Large 7-9
SFFS2XL	XL 10-12

MARLIN AQUA SAILOR LIFE JACKETS



PDF Level 50 (Certified to AS 4758.1)

66954	Aqua Sailor Small 15-25kg
66956	Aqua Sailor Junior 25-40kg
66958	Aqua Sailor Small Adult 40-60kg
669510	Aqua Sailor Adult 60kg Plus
669512	Aqua Sailor Large Adult 60kg Plus
6695S	Aqua Sailor XLarge 60kg Plus
6695M	Aqua Sailor 2XLarge 60kg Plus
6695L	Aqua Sailor 3XLarge 60kg Plus



SWIM GOGGLES

6680	A. SG Rhea
6681	SG Zyg
6682	SG Tethys
6683	Speedo Fear
6684	Speedo Bomber
6685	B. Speedo Futura

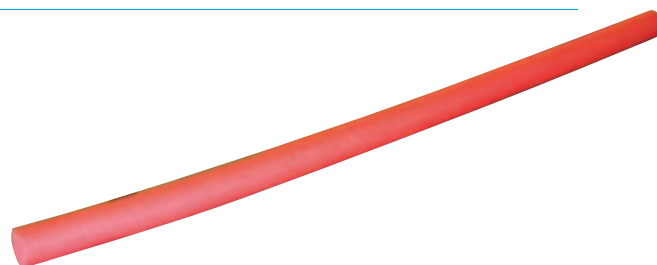

POOL NOODLES

6700	7cm x 165cm
------	-------------



MASK AND SNORKEL SETS

6691	A. SG Standard Mask & Snorkel "Explorer"
6692	B. SG Deluxe Mask & Snorkel "Javelin"



POOL BUOYS

6710	Regular Swim Fit
6711	Large Swim Fit

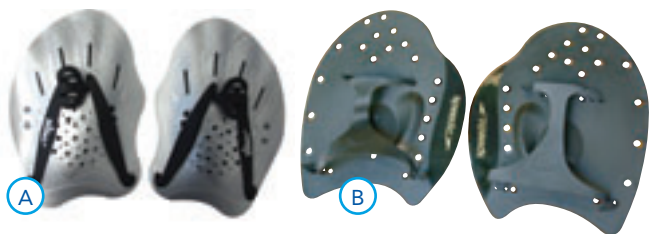

HAND PADDLES

- 6715 **A.** Swim Fit Hand Paddles (One size fits all)
- 6716 **B.** Speedo Power Hand Paddles
- 6717 Replacement Straps



KICK BOARDS

- 6720 Junior 27cm x 22cm
- 6721 Regular 38cm x 23cm
- 6722 Large 43cm x 30cm

SWIMFIT PACER KICKBOARD

100% High-Quality EVA Material
 Size - 39.5cm x 29.5cm x 4cm
 Highly Durable
 Ergonomically shaped to fit perfectly
 Swimming aid to improve swimming kick posture and strength
 Floating aid to assist in swimming confidently

SFKBP

ACCESSORIES

- 6730 **A.** Eyeline Backstroke Flags 6 Lane 17m
- 6731 Eyeline Backstroke Flags 8 Lane 23m
- 673110 Eyeline Backstroke Flags 10 Lane
- 6745 **B.** Nose Clips - Regular S,M,L
- 6747 **C.** Ear Plugs - Silicone
- 6748 **D.** Eyeline Pace Clock
- 6732 **E.** Pacedlock Speedo 900 x 900mm



POOL GAMES

- 6749 **A.** Dive Rings - 6 per pack
- 6750 **B.** Dive Sticks - 6 per pack
- 6751 **C.** Dive Discs - 6 per pack
- 6752 **D.** Dive Seahorses - 4 per pack
- 6753 **E.** Rubber Dive Animals - 4 Per Pack
- 6754 Underwater Hockey **POA**



Please visit www.slatertrellsports.com.au for up to date pricing.



AQUATIC BELT WITH EVA FOAM CONSTRUCTION

- 6760 Small - Medium
- 6761 Large - Extra large



INFLATABLE AQUA BELT

- Not for use under 12yrs old - over 60kg plus.
- 6762 Durable laminated PVC construction



FOAM BLOCK FLOAT BELT

- Not for use under 12yrs old - over 60kg plus
- 6763 8 Eva Foam Blocks



AQUATIC ANKLE & WRIST CUFFS

- 6771 Ankle Cuffs EVA Foam Pair
- 6772 Ankle Cuffs Nylon Covered Cell Foam Pair
- 6812 Wrist Cuffs Nylon Covered Cell Foam Pair



ACCESSORIES

- 6764 Replacement Belt for Small & X Small
- 6765 Replacement Belt for Medium
- 6766 Replacement Belt for Large
- 6767 Replacement Buckle



LYCRA SWIM GLOVES

- 6773 Small Pair
- 6774 Medium Pair
- 6775 Large Pair



MODULAR SET

Includes regular strength latex rubber tubing, hand paddles, handles, mounting loops & leg strap in nylon carry bag.

6776

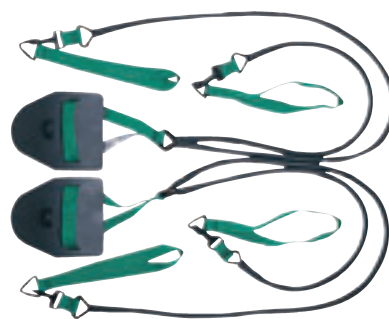

BREASTSTROKE CORDS

Includes twin regular strength latex rubber tubing, hand paddles works both in & outward sweep in the breaststroke pull in nylon carry bag.

6784



KNEE KICK ELASTIC

Controls knee position during breaststroke kick helps facilitate recovery from groin injuries.

6785



HAND PADDLES & MOUNTING LOOPS

6777 Lightweight strength latex rubber tubing in nylon carry bag

6778 Regular strength latex rubber tubing in nylon carry bag

6779 Heavy Duty strength latex rubber tubing in nylon carry bag



SWIM KICK TRAINER

Adds resistance during kicks, sets adds resistance & recovery to legs & abdominal muscles during sessions.

6786

SWIM EXERCISER

5cm waist belt attached to a length regular strength solid rubber tubing.



6780	Regular	\$44.00
6781	Long	\$52.00
6782	X Long	\$82.00
6783	XX Long	\$119.00



PARACHUTE DRAG BELT

6787 Increase resistance training



LONG DOUBLE GRUDGE BELT

Two 5cm waist belts attached with two 400cm lengths regular strength solid rubber tubing in nylon carry bag.

6788



SHORT SWIM BELT

5cm waist belt attached with 120cm latex rubber tubing in nylon carry bag.

6789 Junior Strength

6790 Heavy Duty Strength

X LONG SWIM BELT

5cm waist belt with slider attached to 950cm length regular strength latex rubber tubing in nylon carry bag.

6791



ANKLE TIE

Designed to hold feet together during pull sets webbing with velcro.

6792



ANKLE ELASTIC

Designed to hold feet together during pull sets.

6793

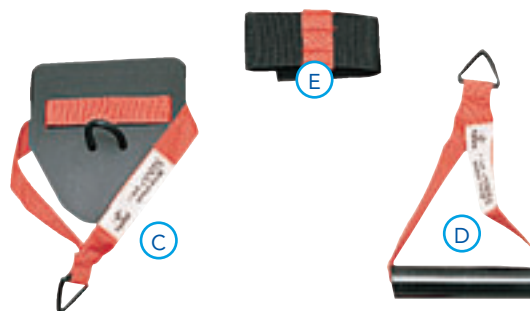
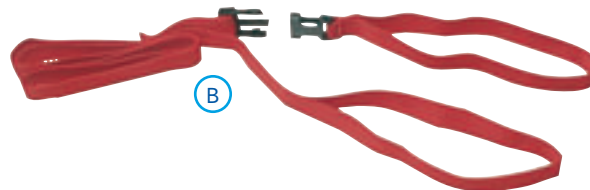

EXA CORDS MODULAR COMPONENTS & REPLACEMENT PARTS

6794 A. Large Swim Parachute

6795 B. Short Belt

6796 C. Modular Hand Paddle

6797 D. Modular Handle

6798 E. Modular Mounting Loop

6799 F. Modular leg strap

6800 G. Small belt 60-85cm

6801 H. Large belt 100-120cm

6802 I. Safety hook

6803 J. 5.0cm belt buckle



ARM BANDS

Durable laminated PVC, multiple air chambers & safety valves.

6804	Size 0 - 1-2yrs
6805	Size 1 - 2-6yrs
6806	Size 2 - 6-12yrs



BAMBINO WINGS

Durable laminated PVC, multiple air chambers & safety valves One size - 1 yr plus.

6807



SWIM RINGS

High strength laminated PVC

6808	Size 1 50cm ring - 19cm inside diameter
6809	Size 2 65cm ring - 30cm inside diameter



KICKBOARD INFLATABLE

High strength laminated PVC, multiple air chambers & handle grips.

6810 One Size Junior



BODY BOARD

This Quality Body Board is suitable for all ages.

6811 Arm Cord is included.

GNARLOO SURFBOARDS

These boards have proven to be the best soft surfboards on the market. Best in performance so people can learn to surf well on them and best as far as usage goes. We have adopted the board inside a board principle that sees an EPS core with a wooden stringer shaped and glassed with epoxy resin. Then it is wrapped in materials that make the board soft. This principle ensures that you get the best of both worlds. Firstly, a board that will perform really well as we can control the shape of the board and therefore the function of the board and secondly we can make the board as soft as it needs for optimum safety. All boards are constructed with heat lamination for added durability.



5470	6'
5471	6'6"
5472	7' 6"
5473	8' 4"
5474	9' 2"

Please visit www.slatertrellsports.com.au for up to date pricing.

SWIMMING



Sponeta®

 Made in Germany



WIR SIND TISCHTENNIS | WE ARE TABLE TENNIS



CORNILLEAU PRO 510 OUTDOOR TABLE TENNIS TABLE

The curved legs of the Pro 510 Outdoor Table make it the most attractive of outdoor tables. Its design allows it to fit in perfectly in the environment of a campsite, caravan park, resort or hotel. This table is also very popular with schools because of its durability.

100% Weatherproof 7mm Table Top

The table can be used in all circumstances and fears neither blows nor bad weather. Its toughness makes it an all-terrain table, and a 7mm playing top allows for a great game and the perfect bounce.

Fixed Steel Net and Steel Base

This table is designed to be fixed to the ground and comes equipped with adjustable screw fittings. It can be installed in public places without risk of theft as the table can be bolted in place using anti-tamper bolts making its permanent leg assembly unable to be removed.

Corner Protection

Protection on each corner of the table to guarantee maximum safety for children.

Ball Dispensers and Bat Storage

Ball dispensers are conveniently within reach of the player, so you are not chasing balls. You can also store 4 bats on either side of the table.

Made in France with 10 Year Warranty

This table is designed, developed and manufactured in France and backed by the best warranty on the market. All outdoor Cornilleau tables are backed by a 10 year warranty that covers all components with the exception of wearing parts such as wheels, the net and net posts. To make sure you continue enjoying your table long after your guarantee period, Cornilleau promise that spare parts will be available to you for 20 years.

Table Assembly

The table comes flat packed and requires full assembly - a YouTube Assembly video "TAB" is attached to this page.

CORNPRO510



ALLIANCE OUTDOOR TABLE TENNIS BAT

2TTABTO03

Red

2TTABTO06

Yellow



CORNILLEAU SOFTBAT OUTDOOR TABLE TENNIS BAT

The world's first eco-design outdoor racket is made from recycling and recovering cotton / polyester fabrics from former ARMOR LUX collections and end of life clothing picked up from a variety of our clients. The SOFTBAT is the first eco-design outdoor racket on the market!

This is an excellent bat for schools. You can throw anything at this bat as it is almost indestructible, which is why it has become so popular with schools & institutions alike. We highly recommend this bat to all recreational players and think it's a steal for the price.

The Perfect Grip

Elastomer that grips and an upper surface that protects, perfect for positioning of the hand. The round ergonomic handle with soft touch grip is comfortable to use and suits youngsters and adults alike.

Playing Surface and Covering

Non-detachable covering is completely resistant to humidity and will not peel. The playing surface SOFTSKIN creates a good amount of spin for your play.

Unlike indoor bats when left outside, outdoor bats are ultra-durable and last for years and years.

CORNBAT1



CORNILLEAU NEXEO X90 CARBON OUTDOOR TABLE TENNIS BAT

The engineers at Cornilleau have developed a patented "durable four-material" technology, as a result they have designed an outdoor Table Tennis Bat that stands apart in terms of performance.

Its sponge-backed smooth rubber provides precision and speed that is also enhanced by Carbon Fibres inside the blade

The materials selected offer improved resistance to shocks and weather conditions

All in all a very durable bat without compromising quality of play.

Rubber - Speed - 80 - Spin - 90 - Control - 80

CORNBAT2



ALLIANCE CONVERSION TABLE TENNIS TOP

- 15mm MDF conversion Table Tennis Top
- Designed to be placed on top of existing tables like a dining table or a billard table
- Total dimensions: 274cm x 152.5cm
- Eva Foam underlayer to protect furniture surfaces & stop from slipping around
- Carton size: 156.0 x 141.0 x 4.0 CM

TTTACT



ALLIANCE TYPHOON TABLE TENNIS TABLE

- Playing Surface: 12mm MDF table top
- Table Top Frame: 20mm x 10mm rectangular frame
- Undercarriage Frame: 25mm x 25mm with cross supports of 20 x 10mm
- 22mm square legs
- Overall size: Length – 274cm Width – 152.5cm Height – 76cm [Official size]
- Folding System: Dual Carriage
- Wheels: 8 x 50mm lockable castor wheels
- Recommended for indoor use only
- Easy Assembly
- Playback facility: fold one half down and keep the other upright to practice by yourself
- **Net and Post Set NOT INCLUDED**
- Carton size: 159.5 x 144.5 x 8CM

30190



ALLIANCE TSUNAMI 15MM TABLE TENNIS TABLE

The Alliance Tsunami Table Tennis Table is designed for those looking for a quality and durable table to provide many hours of entertainment.

A great addition to any home games set up, as well as being suitable for school and club use.

Easy to assemble so you can be playing your first game in no time. Durable so you can play many games for a long time.

Specifications:

- Playing Surface: 15mm MDF table top frame with splash guard technology
- Table Top Frame: 30mm x 20mm
- Undercarriage Frame: main Frame 30mm x 30mm and cross supports 30mm x 20mm
- Overall Size: Length – 274cm Width – 152.5cm Height – 76cm [Official size] -68KG
- Folding System: Table comes as two separate halves which can be folded and placed against each other taking up minimal space when not in use.
- Wheels: 8 x 50mm heavy duty manoeuvrable (4 lockable) wheels
- Playback facility: Fold one half down and keep the other upright to practice by yourself
- Easy Assembly: Simple and easy assembly with the table already 3/4 assembled. Needs two adults and 2 x adjustable spanners to put together. Takes approx. 15 mins. to fully assemble.
- Adjustable feet on all leg supports enabling levelling of playing surface
- Recommended for indoor use only
- Quick opening/closing system with secure safety latch on each table half to keep fixed when folded and 4 safety locking arms to keep the table firmly in place when unfolded.
- **Net and Post Set NOT INCLUDED**
- Carton Size: 159.5 x 144.5 x 13.3 CM

TTTATS15



MB OUTDOOR SPLASH PROOF

- Net Attached
- 35mm Melamine Resin Board
- Metal Frame 36mm
- 4 Double Wheels

6821

Splash Proof



SPONETA OUTDOOR S6-87E TABLE TENNIS TABLE - 10MM BLUE

- The king of outdoor Table Tennis Tables; the advantages of an immovable concrete table but with a bounce like a normal table tennis table
- Playing Surface: 10mm melamine resin board (Blue)
- Table Top Frame: 50mm x 20mm galvanized frame
- Table top has been double strengthened by both the frame and cross section
- Undercarriage Frame: Galvanized sheet steel, powder-coated
- Overall Size: Length: 274cm Width: 152.5cm Height: 76cm
- Table is solid and will need to be fixed/anchored to the standing area
- Extras: Included Net and Post set made of galvanized sheet steel and perfect for the outdoors
- Net thickness: 4mm
- Best possible alternative to a concrete table tennis table
- Carton size: L = 162 x W = 144 x H = 20 cm

TTTSOS6-87E



SG DEVIL ROLLER

- Net Attached
- 16mm MDF Table Top
- Metal Frame 30mm
- 4 Double Wheels

6822



SPIRIT ROLLER TABLE TENNIS TABLE

RECOMMENDED

- Playing Surface: 16mm blue chipboard table top
- Table Top Frame: 36mm frame profile
- Undercarriage frame: 25mm tubular profile
- Overall Size: Length: 274cm Width: 152.5cm Height: 76cm [Official Size]
- Wheels: 4 x 125mm double wheels (2 Fixed and 2 Rotating)
- Playback facility for sole training
- Comes with Net and post set
- Safety bar with holder for balls and bats (bats and balls not included)
- Folding System: Single carriage for easy maneuverability
- Locking system: Hook system with simple and automatic click mechanism
- Recommended for indoor use only
- Manufactured in Germany
- Carton size: H = 162cm x L = 144cm x W = 9cm

6820

TABLE COVER

6830 One Piece

30189 Two Piece

SPONETA REPLACEMENT PARTS KIT

6831



REPLACEMENT SPONETA TABLE TENNIS BALL & BAT HOLDER

6820A



ALLIANCE ECLIPSE 4 STAR TABLE TENNIS BAT

- Advanced level bat - for advanced playing techniques with very good speed and spin
- Blade: 6 ply
- Handle: Alliance D-1 handle - concave/flare style to help prevent slipping
- Rubber: 1.8MM thickness - pimple in
- Sponge: 2.0MM thickness
- Bat Stats:

SPEED: 70
SPIN: 60
CONTROL: 70

TTABTE4



ALLIANCE ECLIPSE 5 STAR TABLE TENNIS BAT

- Advanced level bat - for advanced playing techniques with very good speed and spin
- Blade: 6 ply
- Handle: Alliance D-1 handle - concave/flare style to help prevent slipping
- Rubber: 2.0MM thickness - pimple in
- Sponge: 2.0MM thickness
- Bat Stats:

SPEED: 70
SPIN: 70
CONTROL: 80

TTABTE5



ALLIANCE ECLIPSE 7 STAR TABLE TENNIS BAT

- Professional level bat - with carbon construction for a more powerful attack and sensitive control
- Blade: 7 ply with carbon layers
- Handle: Alliance D-1 handle - concave/flare style to help prevent slipping
- Rubber: 2.0MM thickness - pimple in
- Sponge: 2.0MM thickness
- Bat Stats:

SPEED: 90
SPIN: 80
CONTROL: 80

TTABTE7



ALLIANCE TYPHOON 1 STAR TABLE TENNIS BAT

- Recreational level bat - for fun play with good ball control
- Blade: 5 ply
- Handle: Alliance D-1 handle - concave/flare style to help prevent slipping
- Rubber: 1.4MM thickness - pimple in
- Sponge: 1.5MM thickness
- Bat Stats:

SPEED: 50
SPIN: 40
CONTROL: 50

TTABTT1



ALLIANCE TYPHOON 2 STAR TABLE TENNIS BAT

- Recreational level bat - for fun play with good ball control
- Blade: 5 ply
- Handle: Alliance D-1 handle - concave/flare style to help prevent slipping
- Rubber: 1.4MM thickness - pimple in
- Sponge: 1.5MM thickness
- Bat Stats:

SPEED: 60
SPIN: 40
CONTROL: 50

TTABTT2



ALLIANCE TYPHOON 3 STAR TABLE TENNIS BAT

- Recreational level bat - for fun play with good ball control
- Blade: 5 ply
- Handle: Alliance D-1 handle - concave/flare style to help prevent slipping
- Rubber: 1.8MM thickness - pimple in
- Sponge: 1.8MM thickness
- Bat Stats:

SPEED: 70
SPIN: 50
CONTROL: 60

TTABTT3



ALLIANCE OUTDOOR TABLE TENNIS BAT

- Blade: Polypropylene Paddle
- Rubber: Rubber: PIM-IN 2.0MM
- SPEED: 60 – SPIN: 60 – CONTROL: 50
- Ideal for indoor/outdoor play
- Made with Water resistant Material
- Shock absorption with vented layered construction
- Colours Available: (03) Red, (06) Yellow

2TTABTO03

Red

2TTABTO06

Yellow



ALLIANCE ATTACK 1 STAR TABLE TENNIS BAT

- Recreational bat for beginners and boasts good ball control
- Blade: 5 ply
- Handle: Alliance S-1 handle- anatomical style allows for a good grip
- Rubber: PIM-IN 1.3MM
- Sponge: 1.6MM
- Bat Stats:

SPEED: 40

SPIN: 40

CONTROL: 50

TTABTA

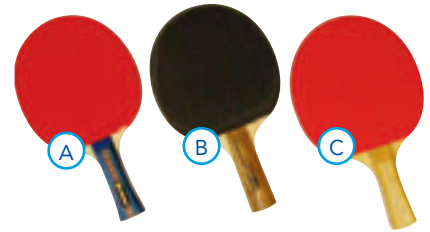

SG TABLE TENNIS BATS

6835 A. Bat SG - Deluxe

6836 B. Bat SG - Standard

6837 C. Bat - Basic

6838 Bat - Plastic



ALLIANCE 4 PLAYER BAT AND BALL TABLE TENNIS SET

Set includes:

- 4 Player Bat & Ball Set includes:
- 4 x Sturdy well constructed Table Tennis Bats
- 4 x Table Tennis Balls (white)
- 1 x Stow-Away Pouch
- Reuse packaging as handy stow away pouch
- Ideal for recreational use and as a start up kit

30191



ALLIANCE 4 PLAYER ECLIPSE TABLE TENNIS SET

Eclipse Table Tennis Set includes:

- 4 x Table Tennis Balls (white)
- 4 x 1* Star quality Bats
- 1 x Pair Sturdy Clip Style Posts
- 1 x Quality Polyester Mesh Net
- 1 x Stow-Away Pouch
- Reuse packaging as handy stow away pouch
- Ideal for recreational use and as a start up kit

TTASET4E



ALLIANCE 4 PLAYER TYPHOON TABLE TENNIS SET

Typhoon Table Tennis Set includes:

- 4 x Table Tennis Balls
- 4 x 1* Table Tennis Bats
- 1 x Pair Screw Style Posts with Mesh Net
- 1 x Stow-Away Pouch
- Reuse packaging as handy stow away pouch
- Ideal for recreational use and as a start up kit

TTASET4T



BUCKET OF TABLE TENNIS BALLS 72 BALLS FLURO ORANGE

6852OJ

72 Balls



ALLIANCE FLURO TABLE TENNIS BALLS

- Bringing a bit of pazazz and colour to your games
- Plastic balls
- Bright fluoro coloured balls: 2 x Green, 2 x Pink and 2 x Yellow
- Packet of 6

2TTABL F



ALLIANCE TABLE TENNIS BALLS 40+ ABS 1 STAR BUCKET OF 60

- Size: 40+
- ABS Plastic cell free balls
- Quality level: 1 Star
- Great for beginners, recreational use, families, schools and training
- Pack of 60 in handy container with handle

TTABL1OP60

Orange

TTABL1WP60

White



BUCKET OF TABLE TENNIS BALLS 72 BALLS FLURO GREEN & YELLOW MIX

6852MIX

72 Balls



ALLIANCE TABLE TENNIS BALLS 40+ ABS 1 STAR ORANGE OR WHITE

- Size: 40+
- ABS Plastic cell free balls
- Quality level: 1 STAR
- Great for beginners, recreational use, families, and schools
- Pack of 6

TTABL1O

Orange

TTABL1

White



ALLIANCE TABLE TENNIS BALLS 40+ ABS 1 STAR ORANGE - PACK OF 36

- Size: 40+
- ABS Plastic cell free balls
- Quality level: 1 Star
- Great for beginners, recreational use, families, schools and training
- Pack of 36 in handy carry bag with handles

TTABL1OP36

Orange

TTABL1WP36

White



BUCKET OF TABLE TENNIS BALLS 72 BALLS WHITE

6852

72 Balls



DHS TABLE TENNIS BALLS D40+ 3 STAR ABS BOX OF 10

- ABS plastic 40+ cell-free-dual table tennis ball
- D40+ cell-free-dual are made from a new material formula that has a more accurate sphericity and better elasticity
- The new material also provides a good bounce trajectory coupled with enhanced durability
- The DHS balls have kept more continuity with the celluloid ball characteristics in hitting sense, drop point, sound, rotation and trajectory
- ITTF APPROVED balls
- Ball of the 2014-2020 ITTF World Championships and most international competitions
- Box of 10 - 3* Balls
- Colour: White

TTDHSBL3ABS



JOSAN TABLE TENNIS BALLS JUMBO 44MM ORANGE

- 44 mm diameter seamless ball
- Larger & heavier than normal table tennis ball
- Slower speed and less spin
- Easier to play & control
- Suitable for learner players
- Colour: Orange

TTJBLJO

SG TABLE TENNIS NET & POSTS

6832	Heavy Duty Deluxe Net & Post Set
6833	Standard Net & Post Set
6834	Sponeta Table Net & Post Set



ALLIANCE TABLE TENNIS NET ONLY

Fits all alliance net and post sets.

TTANO



ALLIANCE ATTACK NET AND POST SET

- Screw style table attachment
- Compact foldaway design
- Polyester knitted net
- Adjustable net tension
- Clamp design expands to fit up to 45mm thick tables

TTANPA



ALLIANCE CLIPMATIC NET AND POST SET

- Clipmatic table clamp
- Compact foldaway design
- Adjustable net tension
- Polyester Net

TTANPC

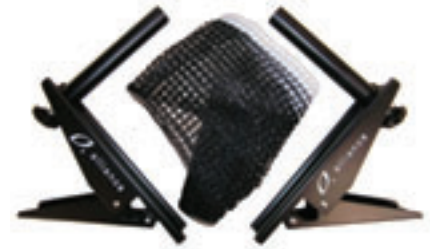

ALLIANCE CLIPMATIC DELUXE II NET AND POST SET

- Clipmatic table clamp
- Sturdy rigid fixed posts
- Retractable post arm
- Adjustable net tension
- Cotton knitted net

TTANPCD2



ALLIANCE ECLIPSE NET AND POST SET

Heavy duty vice frame
Competition grade set
Solid screw on attachment
Sturdy rigid fixed posts
Adjustable net tension
Heavy knitted cotton net
Clamp design expands to fit up to 45mm thick tables

TTANPE



ALLIANCE RETRACTABLE NET AND POST SET

- Quick and simple set up
- Auto retracting system for easy put away
- Clamp design expands to fit up to 50mm thick tables
- Polyester knitted net

TTANPR



ALUMTEC 2600 21"

Junior Racquet with Aluminium Composition. Head size is 92 sq.in. Length 21"

6900



ALUMTEC 2600 23"

Junior Racquet with Aluminium Composition. Head size is 92 sq.in. Length 23"

6901



ALUMTEC 2600 25"

Junior Racquet with Aluminium Composition. Head size is 92 sq.in. Length 25"

6902



ALUMTEC 2510 27"

Junior Racquet with Aluminium Composition. Head size is 100 sq.in. Length 27"

6903



ALUMTEC 2515 27"

Senior Racquet with Aluminium Composition. Head size is 115 sq.in.

6904



FUSIONTEC 580 27"

Senior Racquet with Aluminium and Graphite Composition.

6905



FUSIONTEC 568 L3

Senior Racquet with Aluminium and Graphite Composition.

TNWR568



MASTERPRO 850 L3

The Wish Master Pro series of tennis racquets incorporate advanced Hot Melt Technology.

2TNWR850L3



DELUXE ALUMINIUM 25"

Senior Racquet with Aluminium Composition.

6906



SENIOR GRAPHITE 27"

Senior Racquet with Graphite Composition.

6907



DELUXE GRAPHITE 27"

Senior Racquet with Graphite Composition.

6908



TENNIS GRIP ROLLS

1852 A. Towelling Grip Roll 10m Roll
1853 B. Deluxe Leather Grip 10m Roll



LOOSE PRACTICE TENNIS BALLS

6945 Loose Practice Dozen



WILSON COACHING TENNIS BALLS

6946 Hard & Grass Court Dozen \$29.00



LOW COMPRESSION TENNIS BALLS

6947 Dozen



WILSON LOW COMPRESSION TENNIS BALLS

6952 Green Dot - Stage 1 Dozen



DUNLOP OFFICIAL AUSTRALIAN OPEN TENNIS BALLS

6954 Fluro Green Ball Dozen
6954W White Ball Dozen



LOW COMPRESSION OVERSIZE TENNIS BALLS

6953 Red/Green Oversize Dozen



SLAZENGER HARD COURT TENNIS BALLS

6949 Dozen



SLAZENGER GRASS COURT TENNIS BALLS

6950 Dozen



WILSON TOUR PREMIER ALL COURT TENNIS BALLS

30214 Dozen



WISH TOUR-Y TENNIS BALLS

30192 Dozen



COACHING TENNIS BALLS

6948 Dozen



ALLIANCE BUCKET OF TENNIS BALLS - GREEN 72 BALLS

The Bucket of Tennis Balls has you covered with 72 tennis balls for your tennis match or casual backyard play. Each ball is covered in felt and is a standard tennis ball size with regular bounce and comes in a handy 20 litre bucket with handle and lid for easy storage and transport.

Specifications:

- 20L Bucket
- Carries 72 tennis balls
- Standard size
- Plastic container with lid and handle for storage and transport

TNBL72B11



ALLIANCE BUCKET OF TENNIS BALLS - RED 72 BALLS

The Bucket of Tennis Balls has you covered with 72 tennis balls for your tennis match or casual backyard play. Each ball is covered in felt and is a standard tennis ball size with regular bounce and comes in a handy 20 litre bucket with handle and lid for easy storage and transport.

Specifications:

- 20L Bucket
- Carries 72 tennis balls
- Standard size
- Plastic container with lid and handle for storage and transport

TNBL72B03



ALLIANCE BUCKET OF TENNIS BALLS - BLUE 72 BALLS

The Bucket of Tennis Balls has you covered with 72 tennis balls for your tennis match or casual backyard play. Each ball is covered in felt and is a standard tennis ball size with regular bounce and comes in a handy 20 litre bucket with handle and lid for easy storage and transport.

Specifications:

- 20L Bucket
- Carries 72 tennis balls
- Standard size
- Plastic container with lid and handle for storage and transport

NBL72B04



ALLIANCE BUCKET OF TENNIS BALLS - YELLOW 72 BALLS

The Bucket of Tennis Balls has you covered with 72 tennis balls for your tennis match or casual backyard play. Each ball is covered in felt and is a standard tennis ball size with regular bounce and comes in a handy 20 litre bucket with handle and lid for easy storage and transport.

Specifications:

- 20L Bucket
- Carries 72 tennis balls
- Standard size
- Plastic container with lid and handle for storage and transport

6951

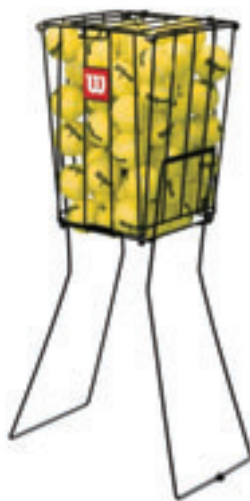

WILSON 75 TENNIS BALL PICK-UP HOPPER

Durable steel construction, holds 75 balls with a no spill lid and handles which convert to lock in place legs for easy use

75BALL

Each



TENNIS BALL TROLLEY

Robust ball trolley which holds 320 balls and comes with a handy lower storage rack ideal for storing ground markers and other training aids. Basket Size: 57cm(L) x 48cm(W) x 42cm(H) Some assembly required. Balls not included. Internal divider can be purchased separately.

19418

Each



TENNIS BALL CART

Lightweight, sturdy aluminium ball trolley on swivel wheels for easy manoeuvrability around the court. Built in zip cover allows balls to be transported in the trolley bag. Trolley snaps open making it easy to set up. Trolley comes with carry bag for easy transportation or storage. Holds 150 balls. Balls not included.

19356

Each



TENNIS COURT SQUEEGEE - WISH

Light weight durable metal frame and large wheels makes draining the court much easier.

Pliable foam blade forms a seal to capture and push water off helping dry the courts faster.

The unique wing design of the squeegee spans 1.5 meters wide, increases work efficiency and minimize water spill.

Also works well for swimming pools, driveways, golf greens and virtually any other flat surfaces, such as construction site cleaning.

Every unit comes with two squeegee blades.

100043 Wish Court Squeegee

TNWCSR Wish Court Squeegee Spare Rubber



WISH RACQUET HOLDER

Portable storage rack for badminton, tennis and squash racquets. Lightweight, sturdy durable PVC coated metal frame has adjustable side strap for added stability. Holds up to 28 racquets. Some assembly required.

1630



TENNIS BALL SERVE DOCTOR

This innovative training aid gives a feeling for correct body position relative to the ball during the service action (or even ground strokes). The Serve Doctor is a simple yet professional training aid consisting of an extension pole and velcro system that attaches to any tennis ball. Just hold the ball in position and have the player hit it right off the rope. It's that simple. Adjustable up to 214cm.

19352

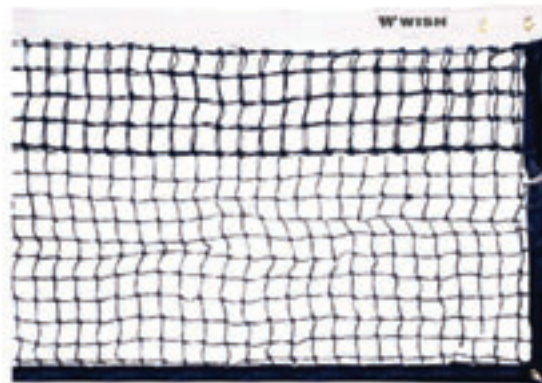

DELUXE DOUBLE MESH TENNIS NET

Double Mesh - Recommended
6920

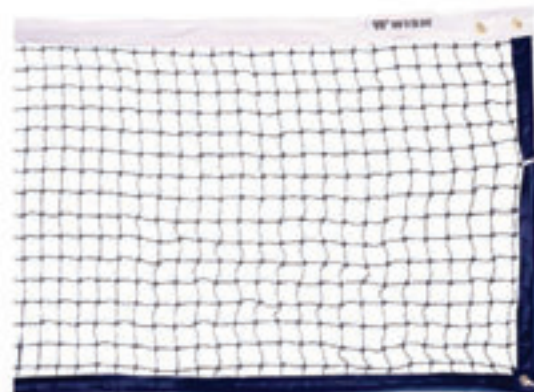

STANDARD SINGLE MESH TENNIS NET

Standard Single Mesh
6921



Please visit www.slatertrellsports.com.au for up to date pricing.

TENNIS



WISH PREMIUM TENNIS NET WINDER

Elevate your tennis court setup with the Wish Tennis Net Winder. Crafted from high-quality heavy-duty steel, this net winder ensures durability and longevity.

With a removable detachable handle in a standard size, it's the perfect companion for clubs, schools, and private courts, making net adjustment a breeze.

Specifications:

- Quality heavy duty steel tennis net winder
- Removable detachable handle (standard size)
- Ideal for clubs, schools and for private courts.

TNWNW



TENNIS SCORE BOARD

Two sided score board. Change the score on one side and it automatically changes the score on the other side. Easy to use. Lightweight to allow easy hanging on fence or umpire's chair. Numbers go up to 7 and are easily changed with the side wheels. Size: 65cm(H) x 46cm(W). Not suitable to be left outdoors permanently.

19310

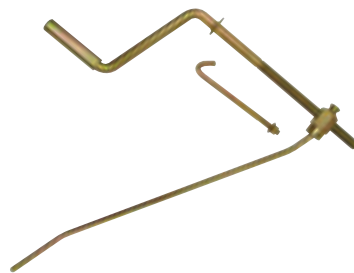

SG TENNIS NET WINDER COMPLETE

6930

Each



TENNIS NET POSTS WITH WINDER

5650

Set

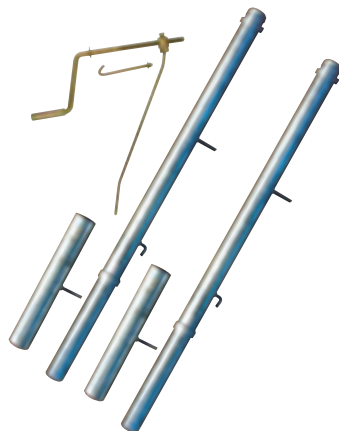

TENNIS NET POSTS WITH WINDER, SLEEVES & END CAPS

5651

Set



NET HANGER

Durable yellow plastic storage hanger suitable for tennis volleyball nets

Easy way to store and carry nets

Net Not Included

TNANH



CENTRE NET STRAP

6931



CENTRE NET STRAP WEIGHT

6931A



**WISH MINI TENNIS NET SYSTEM
5M X 85CM**

- Size: 5M Long x 85cm High
- Steel poles – diameter 19.1mm (3/4")
- Polyester net
- Comes in nylon carry bag with shoulder straps for easy portability and storage

6940



PLASTIC HAND BATS

6046



WISH MINI TENNIS NET SYSTEM - SPARE NET

TNNRMSSN



ALLIANCE TENNIS PORTABLE NET SYSTEM - 3 METRE

The Alliance Tennis Portable Net System comes with a three metre net, two posts, a base system, and a free carry bag for easy storage and transport.

A versatile and easy to setup tennis net and posts set that is ideal for schools, clubs or home uses.

Specifications:

- Powder coated steel tube
- Height: 81cm (32 inch)
- Length: 3m (10 feet)
- Assembly Time: Approx. 5 mins

TNANPS3



**LOBSTER
TENNIS BALL MACHINES**

The Lobster Sports Elite Series is the only battery tennis ball machine that can live up to your expectations of high quality, durability, and innovation. In addition, Lobster Sports Elite Series machines are backed by the only 3 year – unlimited warranty in the industry. Four Elite models are available: the Elite Freedom economy model, the Elite 1 base model, the Elite 2 with triple oscillation, and the Elite 3 with not only triple oscillation, but ground-breaking two-line functionality combined with triple oscillation — so effective, you might forget you're playing against a machine!

6960

Please visit www.slatertrellsports.com.au for up to date pricing.



DELUXE TIMER

5934



STANDARD TIMER

5935

OTHER MODELS OF VULY TRAMPOLINES ARE AVAILABLE.

PLEASE VISIT WWW.SLATERGARTRELLSPORTS.COM.AU



TRAMPOLINES - VULY ULTRA

VULT01	Vuly Ultra Trampoline Set - Small
VULT02	Vuly Ultra Trampoline Set - Medium
VULT03	Vuly Ultra Trampoline Set - Large
VULT04	Vuly Ultra Trampoline Set - XL



GYMBOSS CLASSIC TIMER

The Classic Gymboss timer is perfect for anyone looking for a dedicated interval timer for daily workouts. 1 or 2 intervals - 2 seconds to 99 minutes. Repeat up to 99 times. Beep and/or Vibrate alarm. Alarm duration 1, 2, 5, or 9 seconds. Stopwatch function. Clock function. Secure removable Belt clip. Compact Size (1 3/4 x 2 1/4 x 1/2 inches). Water and shock resistant. AAA battery required.

5936 Gymboss Classic Timer



TUFF GATOR SKIN DODGEBALLS.

6020R	Soccer Ball 213mm Red
6020B	Soccer Ball 213mm Blue
6020G	Soccer Ball 213mm Green
6020Y	Soccer Ball 213mm Yellow
60216	210mm Set of 6 Colours
60226	160mm Set of 6 Colours

VOLLEYBALLS



MINI PINK

6048 Size: 6"
6047 Size: 8"



RUBBER BALL

7000



BADEN MATCHPOINT

BMP001



BADEN LEXUM

BLEXVB



BADEN LIGHT VOLLEYBALL

BLVB



WILSON IMPACT

7002



WILSON MATCHPOINT SOFTPLAY

7001



MOLTEN V5M4500

7005



MIKASA V200W

7010



MIKASA V300W

7011



MIKASA V330W

7012



MIKASA VT370W WEIGHTED TRAINING BALL 370G

7013



MIKASA SKVS SPIKEZONE

7015



VOLLEYBALL BAG

MIKASA

7051

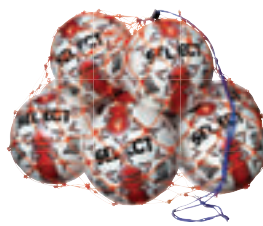

STRING BAGS

2033 Large
2034 Medium
2035 Small



NYLON GEAR BAG

PATRICK

2032

Please visit www.slatertrellsports.com.au for up to date pricing.

VOLLEYBALL

BEACH VOLLEYBALLS



MOLTEN BV5000
FIRST GRADE

7020



MIKASA VLS300
FIRST GRADE - SYN LEATHER

7021



MIKASA VXT30
MATCH - SYN LEATHER

7022



MIKASA SOFT SAND
TRAINING

7023



BALL TOTE ON WHEELS

- 6567 **A.** SG Ball Tote on Wheels
- 6567M **B.** Molten Ball Tote on Wheels



CROSSNET
FOUR SQUARE MEETS VOLLEYBALL

CROSSNET is the world's first four square volleyball game. Set up within minutes in sand, grass, or indoors.

- Height adjustable for men (2.4m), women (2.2m), and children (1.7m)
- Perfect for backyards, beach days, and BBQs
- All orders come with an official CROSSNET™ four-way net, poles, and volleyball

100215



VOLLEYBALL NETS

- 7030 **A.** Competition Volleyball Net - Nylon Cable
- 7031 **B.** Match - Nylon Cable
- 7032 **C.** Super Match - Nylon Cable
- 7033 Tournament - Wire Cable
- 7034 Acromat DLX Volleyball Net - Nylon Cord
- 7035 **D.** Beach Volleyball Net - Nylon Cble
- 7036 Volleyball Antenna

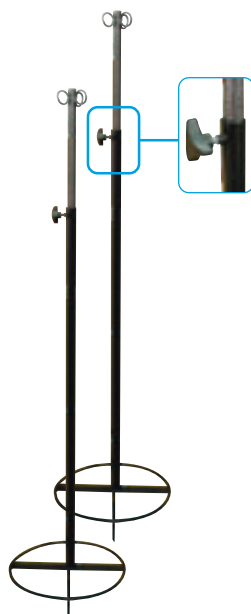

VOLLEYBALL STANDS PER PAIR

Adjustable stands with round base and spike.
7046



ALL IN ONE STAND HD PORTABLE

Includes all attachments to play Badminton, Tennis, Volleyball & Netball.
Heavy Duty Weighted Base with wheels.
1669

Pair



BADEN SAND SHARK

BSS001



GUY ROPES

Guy Ropes 6mm (Twin Pack 3m)

7045

\$13.00



SCORE CHART FLIP OVER

7050

\$46.00



ELSON PORTABLE VOLLEY DELUXE

Portable kit used by the USA GOLD MEDAL WINNING BEACH VOLLEYBALL OLYMPIC TEAM. Kit Includes: Poles, Net, Guy Ropes, Boundary Line, Carry Bag & Instructions.

7040 A. Volleyball Kit Elson

7043 Beach Sand Kit - Ropes and Border

SG DELUXE VOLLEYBALL NET & POST KIT

VYDVK SG Deluxe Kit

PORTABLE VOLLEYBALL STANDS

Weighted heavy duty base with swivel wheels. Includes modified net heights.

Note: The bases can also be used for Badminton. (Badminton posts will need to be purchased).

1661	A. Portable VB Stands Complete	Pair
1662	B. Portable Bases Only	Pair
1663	Spare Base	Each
1664	Volleyball Posts Only	Pair
1666	C:20kg Sand Bag	Each



Sand Bag - Must be used with the Volleyball Stand.



KNEE PADS VOLLEYBALL

7060	A. Club - Flat S,M,L
7061J	B. Competition - Junior
7061S	B. Competition - Senior
7063	C. Senior match - Senior Size Only
7064JW	D. Joust Pads - Junior - White
7064JK	D. Joust Pads - Junior - Black
7064SW	D. Joust Pads - Senior - White
7064SK	D. Joust Pads - Senior - Black

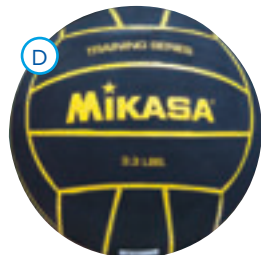

WATER POLO BALLS

7100	A. Molten Mens
7103	B. Mikasa W6000 Mens
7104	C. Mikasa W6009 Womens
7105	D. Mikasa Weighted Training Ball



SWIM FIT WATER POLO CAP SET

Swim Fit - Water Polo Set includes 26 Caps. (12 x White Caps Numbered 2-13) (12 x Blue Caps Numbered 2-13) (2 x Red Caps Number 1)

7110 Swim Fit Cap Set

EYELINE WATER POLO CAP SET

Eyeline - Water Polo Set includes 13 Caps.

Colours Available: Black, Navy, Royal, Maroon, Dark Green (Number 1 Red Cap)

7111 Eyeline Cap Set

7112 Eyeline Cap Single

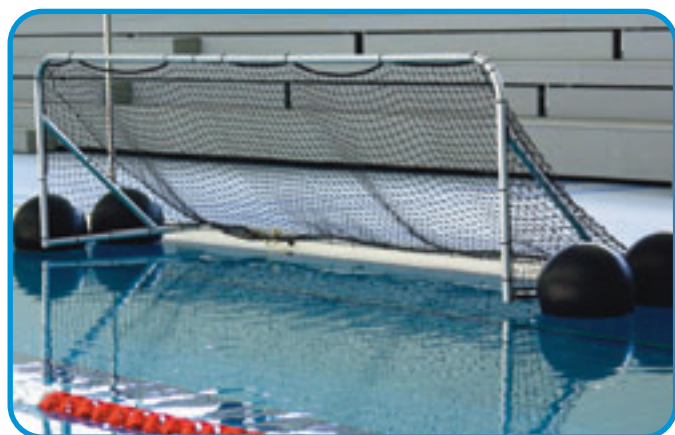

WATER POLO GOALS

Aluminium construction with 4 large floats on each goal. Sold as a Pair.

4550	Water Polo Goals 1800 x 900mm	Pair
4551	Water Polo Goals 3000 x 900mm	Pair

ANTI WAVE PRO 1080 WATER POLO GOAL

The Anti Wave Pro Floating Goal was first introduced at the 1972 Olympic Games in Munich, Germany. This premium water polo goal features a powder coated aluminium frame, reinforced with fiberglass, and a tough, polypropylene net that is knotted at every intersection. The EVA foam floats offer superior, even flotation for maximum goal stability. Small deck wheels allow the goal to be moved easily along the pool deck.

- Full-sized competition floating goal
- Strong, powder-coated aluminium frame, with 3m x .9m face
- Patented open corner net design to reduce ball rebound
- Net is tough polypropylene cord, knotted at every intersection
- Durable fiberglass flotation panels provide even position in the water

ANTI001 Note: Freight will be calculated on purchase.





PULL TOP WATER BOTTLE

Standard Pull Top Waterbottle. 1lt capacity.

7175



CHIN REST WATER BOTTLE

The Chin Rest Water Bottle safely positions the users mouth away from the outlet nozzle, reducing the risks of infection and offering greater safety for athletes. 1lt capacity.

7176



WATER BOTTLE CARRIERS

7185 8 Water Bottle Carrier

7186 12 Water Bottle carrier

7187 16 Water Bottle carrier



SQUEEZE WATER BOTTLE

30193



WATER BOTTLE CARRIER FOLDABLE

Heavy duty plastic frame with solid base. Folds flat for easy storage when not in use.

7189 6 Water Bottle Carrier

7190 8 Water Bottle Carrier

7191 10 Water Bottle Carrier



V8 BOTTLE CARRIER

100% Australian Made. Made from tough and durable Polypropylene. Can be nested for easy storage. Colours can be mixed to match team colours. Holds 8 Pull Top Style Water Bottles.

7177 Blue

7178 Red

7179 Yellow

7180 Green

7181 Black

7182 White



YOGA BLOCK

30194 Blue

30216 Purple

30217 Pink



FOAM YOGA MAT

7170



PERSONAL MAT STANDARD

4911 Standard 900 x 600mm

4910 Deluxe 1200 x 600mm



**FOX SONIK
CUSHION MOUTHGRIP
WHISTLE**

FOX001



**FOX MCMG
MINI CUSHION
MOUTHGRIP WHISTLE**

FOX002



**FOX CMGB
CUSHION MOUTHGRIP
WHISTLE**

FOX003



**FOX EW
ELECTRONIC
WHISTLE**

FOX004

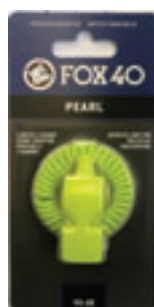

**FOX PFN
PEARL WITH WRIST COIL
WHISTLE**

FOX005



**FOX OFB
FINGERGRIP
WHISTLE**

FOX006



FOX CLASSIC WHISTLE

- 7154P Pink
- 7154 Black
- 7154R Red
- 7154O Orange
- 7154Y Yellow
- 7154B Blue
- 7154NG Neon Green
- 7154W White
- 7154PU Purple
- 7154NY Neon Yellow



**FOX PB
PEARL
WHISTLE**

FOX007



**FOX CLASSIC
WHISTLE
WITH LANYARD**

FOX008 Black Only



SG FINGERGRIP METAL WHISTLE

7157



ACME THUNDERER AFL UMPIRE FINGER GRIP METAL WHISTLE

7151



ACME FINGERGRIP WHISTLE PLASTIC

7152



ACME METAL WHISTLE WITH LANYARD

7153



ACME THUNDERER PLASTIC WHISTLE WITH LANYARD

7150



SG METAL WHISTLE WITH LANYARD

7156



SQUISTLE

7155



SG PLASTIC WHISTLE WITH OR WITHOUT LANYARD

- 7158 Black - With Lanyard
- 30195 Red - With Lanyard
- 30196 Blue - With Lanyard
- 30197 Yellow - With Lanyard
- 30198 Green - With Lanyard
- 7159 Black - Without Lanyard
- 30199 Red - Without Lanyard
- 30200 Blue - Without Lanyard
- 30201 Yellow - Without Lanyard
- 30202 Green - Without Lanyard



ELECTRONIC WHISTLE WITH LANYARD

7161 With lanyard



ALLIANCE SQUEEZY WHISTLE - DELUXE

SAWSD



LANYARDS

7160

Please visit www.slatertrellsports.com.au for up to date pricing.

WHISTLES

CUSTOM TEAMWEAR

**YOUR TEAM OR CLUB CAN NOW
LOOK LIKE TRUE PROFESSIONALS.**

Slater-Gartrell Sports clothing range offers a combination of high performance fabrics in conjunction with a comfortable and functional fit to meet a player's match and training kit requirements at every level.

Slater-Gartrell Sports understands the needs of teams and our range of high performance stock match shirts, training wear and leisure garments combined with an extensive range of customised options cater for every scenario.

Our specialised design team can assist and advise on every aspect of incorporating your specific school, club or university colours onto any garment.

Our embroidery and printing facilities allow quick turnaround on stock items which can all be embellished with your club logo, numbers and or sponsor logo.



**SLATER-GARTRELL
SPORTS**

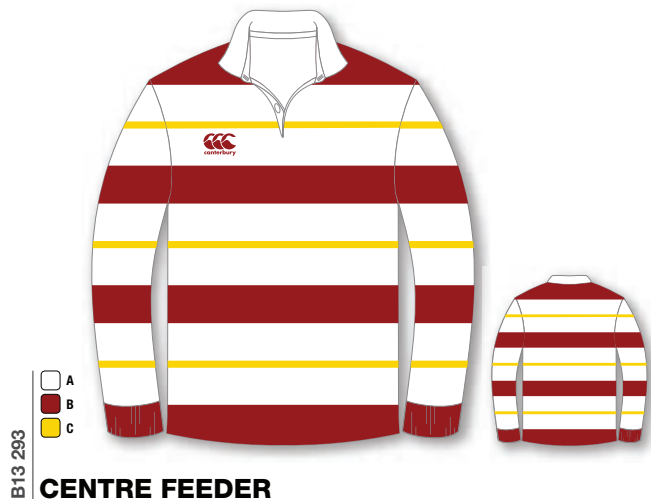

B13194 **MENS DYO WITH SET IN SLEEVE**
 B13238 **MENS DYO WITH RAGLAN SLEEVE**

SIZING XS-4XL | **FITS** MATCH FIT | **FABRIC** POLYCOTTON JERSEY 315GSM

SLEEVES SHORT | **NECK & COLLAR** LOOP NECK WITH SPORTS OR STUB COLLAR

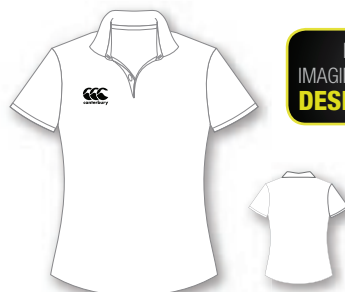

DONT LET OUR
 IMAGINATION LIMIT YOURS
DESIGN YOUR OWN

B13195 **MENS & KIDS DYO RAGLAN SLEEVE**
 B13560 **MENS & KIDS DYO SET IN SLEEVE**
 B13589 **MENS & KIDS DYO VERTICAL STRIPE WITH SET IN SLEEVE**
 B13570 **MENS & KIDS DYO C&S WITH SET IN SLEEVE**

SIZING XXS-6XL | **FITS** CLASSIC FIT | **FABRIC** POLYCOTTON JERSEY 310GSM
 4-14

SLEEVES SHORT, 3/4, LONG WITH CUFF OR HEMMED | **NECK & COLLAR** LOOP NECK WITH SPORTS OR STUB COLLAR, BUTTON THROUGH PLAQUET OR CONCEALED PLAQUET

B13054 **WOMENS DYO**
SIZING 8-24 | **FITS** WOMENS | **FABRIC** POLYCOTTON JERSEY 310GSM

SLEEVES SHORT, 3/4, LONG WITH CUFF OR HEMMED | **NECK & COLLAR** SPLIT NECK WITH SPORTS COLLAR, LOOP NECK WITH SPORTS OR STUB COLLAR, BUTTON THROUGH PLAQUET



NEMESIS



CURVE



CENTRE



INTERNATIONAL PRO



RANDWICK



OPTIMUM



ZEUS



QUAKE



WARRIOR



SOLOMAN

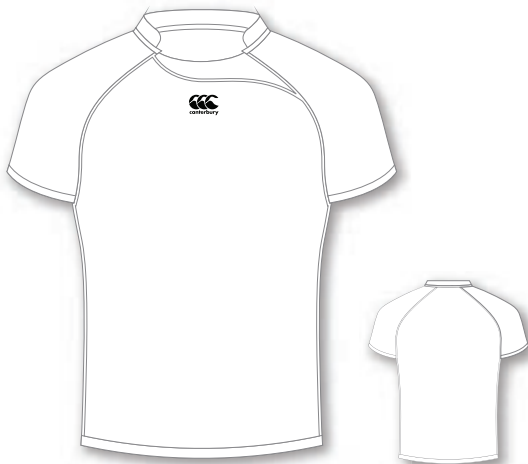

B13 1156 **MENS DYO ELITE**
B13 1154 **MENS & KIDS DYO SLIM FIT SUBLIMATE**

SIZING
XXS - 4XL
4 - 14

FITS
ELITE FIT
SLIM FIT

FABRIC
EVEREST 290GSM
SUBLIMATE JERSEY 300GSM

SLEEVES
SHORT

NECK & COLLAR
RWC NECK AND COLLAR

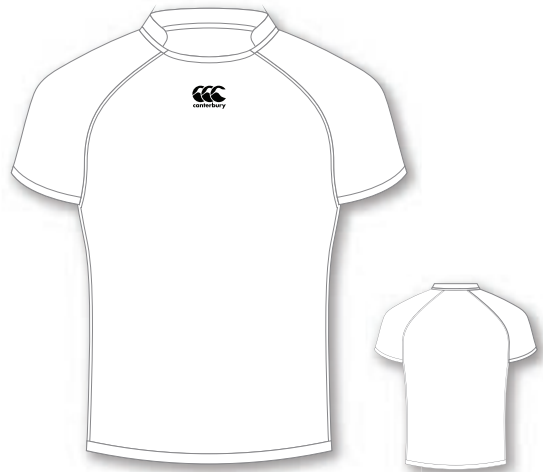

B13 1170 **MENS DYO SLIM FIT SUBLIMATE**

SIZING
XS - 4XL

FITS
SLIM FIT

FABRIC
SUBLIMATE JERSEY 300GSM

SLEEVES
SHORT

NECK & COLLAR
ROUND NECK WITH RWC COLLAR

CUSTOM - SUBLIMATED JERSEYS



- A
- B
- C

ISIS



- A
- B
- C

MUSE



- A
- B
- C

SAINT



- A
- B

INTERNATIONAL HARLEQUIN



- A
- B

STAUNCH



- A
- B

CONTENDER



GILLS



HORIZONTAL



HIGH TOWER



WAIT

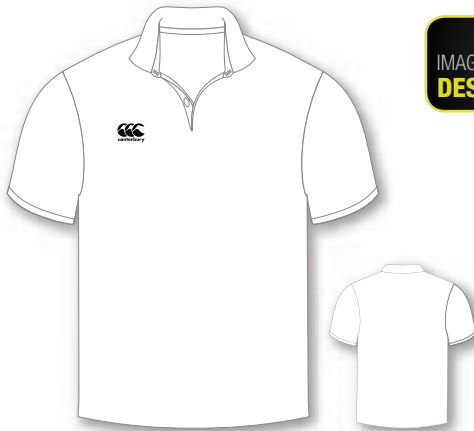

DONT LET OUR
IMAGINATION LIMIT YOURS
DESIGN YOUR OWN

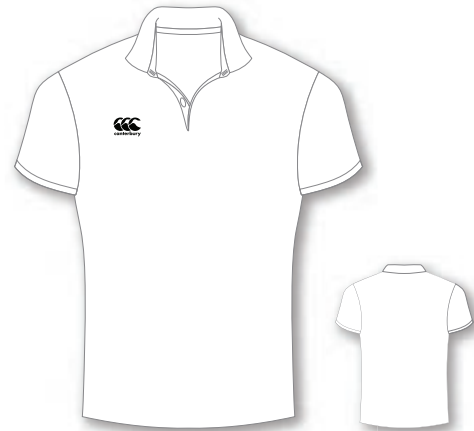

B13 620 (Aus) B13 800 (NZ) **MENS & KIDS DYO SET IN SLEEVE**
B13 196 (Aus) B13 800R (NZ) **MENS & KIDS DYO RAGLAN SLEEVE**

B13 866 **MENS DYO SET IN SLEEVE**
B13 237 **MENS DYO RAGLAN SLEEVE**

SIZING XS - 6XL
4 - 14
FITS CLASSIC FIT
FABRIC SUBLIMATE JERSEY 300GSM

SIZING XS - 6XL
FITS MATCH FIT
FABRIC SUBLIMATE JERSEY 300GSM

SLEEVES SHORT, 3/4, LONG WITH CUFF OR HEMMED
NECK & COLLAR LOOP NECK WITH SPORTS OR STUB COLLAR, V NECK WITH RIB OR SF TRIM, ROUND NECK WITH RIB TRIM

SLEEVES SHORT
NECK & COLLAR LOOP NECK WITH SPORTS OR STUB COLLAR, V NECK WITH RIB OR SF TRIM, ROUND NECK WITH RIB TRIM

T52 828



DYO SUBLIMATE SHORT (LEAGUE)

SIZING 22" - 50"	FITS ADULTS	FABRIC POLYESTER KNIT 235GSM
----------------------------	-----------------------	--

T52 686



DYO SIDE PANEL (AFL)

SIZING 28" - 46"	FITS ADULTS	FABRIC POLYESTER KNIT 235GSM
----------------------------	-----------------------	--

T52 0010

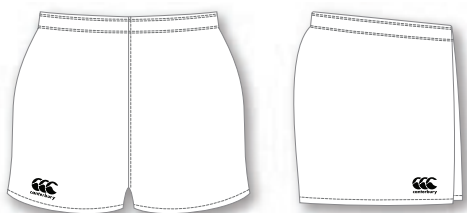

POLYESTER SUBLIMATE SHORT (AFL)

SIZING 28" - 46"	FITS ADULTS	FABRIC POLYESTER KNIT 235GSM
----------------------------	-----------------------	--

T52 126 - ADULTS
T72 126 - KIDS

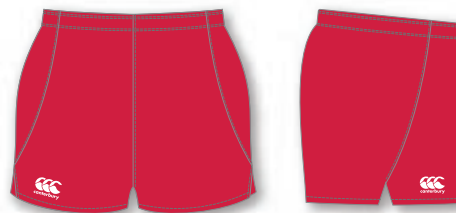

TASLON (TRAINING)

SIZING XS - 4XL 6 - 14	FITS ADULTS KIDS	FABRIC POLYESTER TASLON 110GSM
-------------------------------------	-------------------------------	--

T52 514

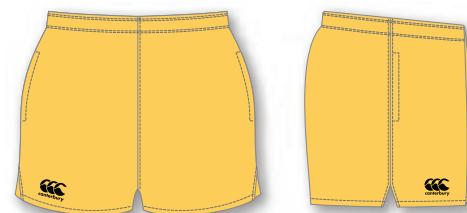

TACTIC SHORT (TRAINING)

SIZING XS - 4XL	FITS ADULTS	FABRIC POLYESTER TASLON 110GSM
---------------------------	-----------------------	--

T52 1657



ELITE TRAINING SHORT (TRAINING)

SIZING XXS - 3XL	FITS ADULTS	FABRIC POLYESTER TASLON 110GSM
----------------------------	-----------------------	--

T52 0010S



SIDE STRIPE (AFL)

SIZING 28" - 46"	FITS ADULTS	FABRIC POLYESTER KNIT 235GSM
----------------------------	-----------------------	--

T52 133 - ADULTS
T72 133 - KIDS



LONG LEG TACTIC (TRAINING)

SIZING XS - 4XL 6 - 14	FITS ADULTS KIDS	FABRIC POLYESTER TASLON 110GSM
-------------------------------------	-------------------------------	--



T52 125



SPRINT (RUGBY)

SIZING 28" - 46"	FITS ADULTS	FABRIC COTTON DRILL 280GSM
----------------------------	-----------------------	--------------------------------------



T52 223



ACTION SHORTS (RUGBY)

SIZING 22" - 50"	FITS ADULTS	FABRIC COTTON DRILL 280GSM
----------------------------	-----------------------	--------------------------------------



T52 321



HARLEQUIN (RUGBY)

SIZING 26" - 50"	FITS ADULTS	FABRIC COTTON DRILL 280GSM
----------------------------	-----------------------	--------------------------------------

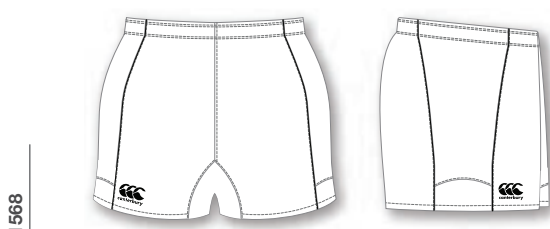

T52 1568

DYO SUBLIMATE ADVANTAGE SHORT (RUGBY)

SIZING 28" - 48"	FITS ADULTS	FABRIC POLYESTER TWILL 215GSM WITH POLYESTER/ LYCRA® CROTCH GUSSET & SIDE HEM PANELS
----------------------------	-----------------------	---

SPECIAL FEATURES
GRIPPER ELASTIC IN WAIST



T52 260



DYO SUBLIMATE SIDE PANELS (LEAGUE)

SIZING 22" - 50"	FITS ADULTS KIDS	FABRIC POLYESTER TRICOT 155GSM
----------------------------	-------------------------------	--



T52 266



DYO TRIANGLE SIDE PANEL (LEAGUE)

SIZING 22" - 50"	FITS ADULTS KIDS	FABRIC POLYESTER TRICOT 155GSM
----------------------------	-------------------------------	--



T52 1580



CUT & SEW ADVANTAGE SHORT (RUGBY)

SIZING 28" - 48"	FITS ADULTS	FABRIC POLYESTER TWILL 215GSM WITH NYLON SPANDEX CROTCH GUSSET & SIDE HEM PANELS
----------------------------	-----------------------	---

SPECIAL FEATURES
GRIPPER ELASTIC IN WAIST



T52 1538

DYO SUBLIMATE TRICOT SHORT (LEAGUE)

SIZING 22" - 50"	FITS ADULTS KIDS	FABRIC POLYESTER TRICOT 155GSM
----------------------------	-------------------------------	--

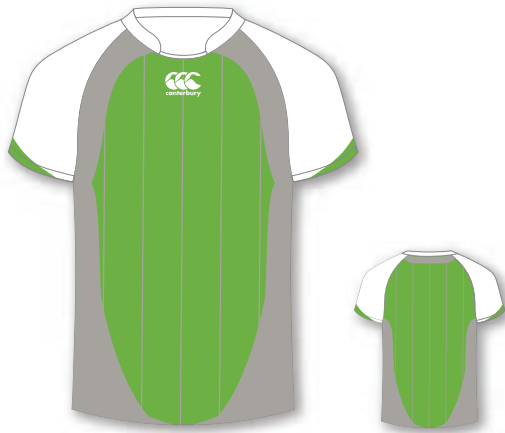

FORMATION



CROSS OVER



THOR



FOX



SUNRISE



TRAPPED



KEEPER

DONT LET OUR
IMAGINATION LIMIT YOURS
DESIGN YOUR OWN

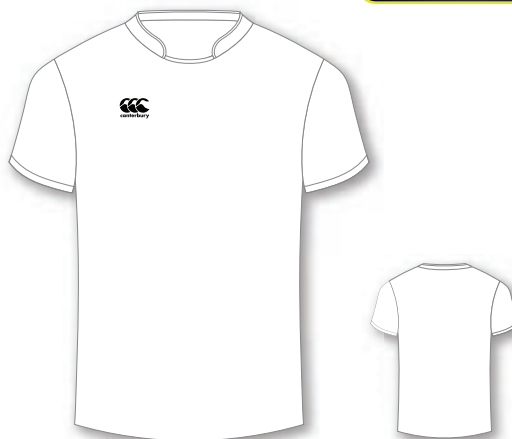

T54 3886 **MENS & KIDS DYO SET IN SLEEVE**
T54 4050 **MENS & KIDS DYO RAGLAN SLEEVE**

SIZING XS - 4XL 6 - 14	FITS SLIM FIT	FABRIC 324 - SUBLIMATE PERFORMANCE 180GSM 111 - SUBLIMATE SPORTS MESH 150GSM 555 - ELITE LIGHT WEIGHT SUB 139GSM
SLEEVES SHORT, LONG HEMMED	NECK & COLLAR SELF FABRIC PREMIER LEAGUE COLLAR	



FERN

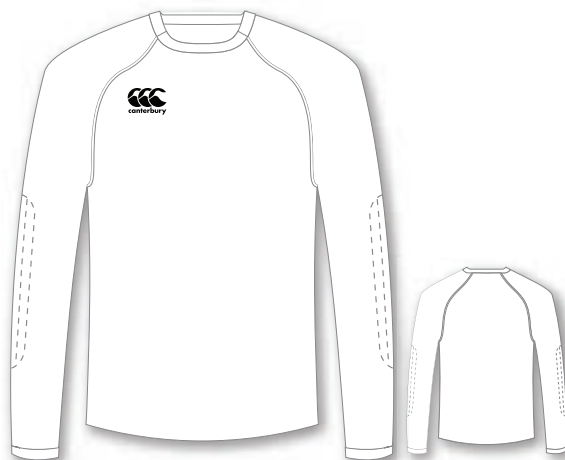

T54 4138

DYO GOALIE TOP

SIZING S - 3XL	FITS SLIM FIT	FABRIC 100 - SUBLIMATE PERFORMANCE 150GSM 324 - SUBLIMATE PERFORMANCE 180GSM 111 - SUBLIMATE SPORTS MESH 150GSM 555 - ELITE LIGHT WEIGHT SUB 139GSM
--------------------------	-------------------------	--

SLEEVES LONG	SPECIAL FEATURES PADDING ON OUTER ELBOWS SELF FABRIC PIPING AND CUFFS
------------------------	--

NOTE: MINIMUMS DO NOT APPLY

B18 242 - MENS & KIDS DYO SET IN SLEEVE CLASSIC
B18 243 - MENS & KIDS DYO RAGLAN SLEEVE CLASSIC
B18 3254 - MENS & KIDS DYO SET IN SLEEVE SLIM
B18 3255 - MENS & KIDS DYO RAGLAN SLEEVE SLIM



MENS & KIDS DYO

SIZING XXS - 4XL 6 - 14	FITS CLASSIC FIT SLIM FIT	FABRIC 100 - SUBLIMATE PERFORMANCE 150GSM 324 - SUBLIMATE PERFORMANCE 180GSM 111 - SUBLIMATE SPORTS MESH 150GSM
--------------------------------------	--	---

SLEEVES SHORT, 3/4, LONG WITH CUFF OR HEMMED	NECK & COLLAR ROUND NECK WITH SELF FABRIC TRIM, PLAQUET NECK WITH SELF FABRIC COLLAR, V NECK WITH SELF FABRIC TRIM, V NECK WITH SELF FABRIC COLLAR & TRIM
---	---

Please visit www.slatertrellsports.com.au for up to date pricing.

CUSTOM - SPORTS TOPS



- A
- B
- C

FORMATION



- A
- B
- C

CROSS OVER



- A
- B
- C
- D

THOR



- A
- B
- C

SUNRISE

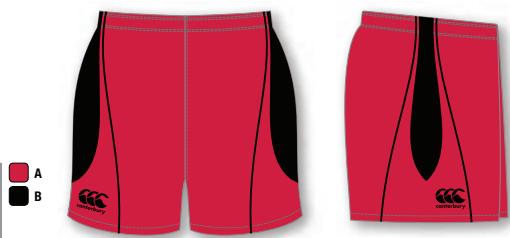

- A
- B

TRAPPED

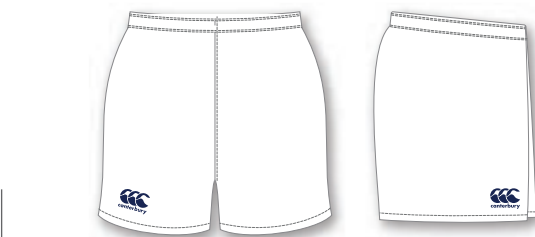

T52 830/S **DYO SHORTS**
T72 830 **KIDS DYO SHORTS**

SIZING
26" - 50"
6 - 14

FITS
ADULTS
KIDS

FABRIC
100 - SUBLIMATE PERFORMANCE 150GSM
324 - SUBLIMATE PERFORMANCE 180GSM
111 - SUBLIMATE SPORTS MESH 150GSM

SPECIAL FEATURES
SHORTER LENGTH IS 4.5CM SHORTER THAN REGULAR

DONT LET OUR
IMAGINATION LIMIT YOURS
DESIGN YOUR OWN

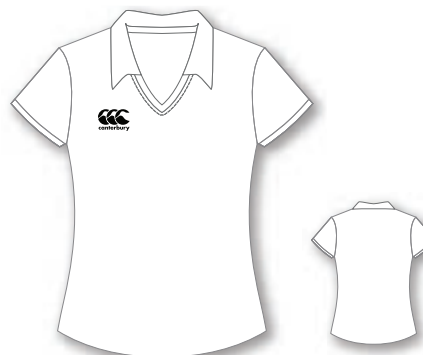

ADULTS

T63 299 **DYO NETBALL TOP CAP SLEEVE**
T63 323 **DYO NETBALL TOP SHORT SLEEVE**
T66 863 **DYO NETBALL TOP SLEEVELESS**

KIDS

T73 299 **DYO NETBALL TOP CAP SLEEVE**
T73 323 **DYO NETBALL TOP SHORT SLEEVE**
T76 863 **DYO NETBALL TOP SLEEVELESS**

SIZING
8 - 24 (cap &
short sleeve)
6 - 20
(sleeveless)
6 - 14

FITS
WOMENS
KIDS

FABRIC
100 - SUBLIMATE PERFORMANCE 150GSM
324 - SUBLIMATE PERFORMANCE 180GSM
111 - SUBLIMATE SPORTS MESH 150GSM

SLEEVES
SHORT, CAP OR
SLEEVELESS

NECK & COLLAR
V NECK WITH SELF FABRIC TRIM, V NECK WITH SELF FABRIC
TRIM & COLLAR, OR V NECK WITH SELF FABRIC TRIM &
KNITTED COLLAR



- A
- B
- C

TENACIOUS



- A
- B
- C

CHILE



- A
- B
- C

MISCHIEF



- A
- B
- C

REBOUND



- A
- B
- C

STAMINA



- A
- B
- C

AFTER SHOCK



TENACIOUS SKORT



CHILE SKORT



REBOUND SKIRT



STAMINA SKIRT



AFTER SHOCK SKIRT



MISCHIEF SKORT

DONT LET OUR IMAGINATION LIMIT YOURS
DESIGN YOUR OWN

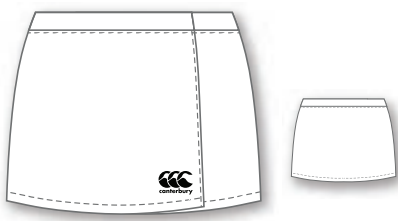

T67 000 - ADULTS
T77 000 - KIDS

DYO WRAP NETBALL SKIRT

SIZING	FITS	FABRIC
8 - 24	WOMENS	100 - SUBLIMATE PERFORMANCE 150GSM
6 - 14	KIDS	324 - SUBLIMATE PERFORMANCE 180GSM
		111 - SUBLIMATE SPORTS MESH 150GSM

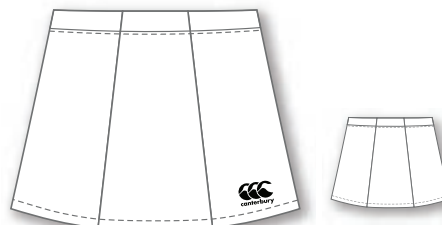

T67 095 - ADULTS
T77 095 - KIDS

DYO 6 PANEL SKIRT

SIZING	FITS	FABRIC
6 - 24	WOMENS	100 - SUBLIMATE PERFORMANCE 150GSM
6 - 14	KIDS	324 - SUBLIMATE PERFORMANCE 180GSM
		111 - SUBLIMATE SPORTS MESH 150GSM



■ A/LETTERS
■ B

- T20 810 **BIB 18.5cm x 18.5cm**
- T20 812 **BIB 22cm x 18.5cm**
- T20 433 **BIB 16cm x 23cm**
- T20 069 **BIB 22cm x 20cm**

FABRIC

- 100 - SUBLIMATE PERFORMANCE 150GSM
- 324 - SUBLIMATE PERFORMANCE 180GSM
- 111 - SUBLIMATE SPORTS MESH 150GSM

SPECIAL FEATURES

- T20 810 SUITABLE FOR TOPS. 1 SET = 7 POSITIONS (14 BIBS) NZ NETBALL STANDARDS
- T20 812 SUITABLE FOR DRESSES. 1 SET = 7 POSITIONS (14 BIBS) NZ NETBALL STANDARDS
- T20 433 SUITABLE FOR TOPS. 1 SET = 7 POSITIONS (14 BIBS) NZ NETBALL STANDARDS
- T20 069 SUITABLE FOR TOPS. 1 SET = 7 POSITIONS (14 BIBS) AUST. NETBALL STANDARDS



■ A
■ B
■ C

GOAL



■ A
■ B

AMAZON



■ A
■ B

BUBBLES



■ A
■ B
■ C

UPRISING



■ A
■ B
■ C

ELECTRA



T67 024S/L
 A
 B
 C
 D

COVERSTITCH



T67 089S/L
 A
 B
 C
 D

OFF SHOOT



A
 B
 C

FLICK



T67 099S/L
 A
 B
 C/DYO

DYO SUBLIMATE SIDE PANEL DRESS



T67 079
 T67 094
 T67 110

WOMENS BODY SUIT

SIZING	FITS	FABRIC
4 - 28 (T67 079) 6 - 24	WOMENS	SUBLIMATE POLYESTER / LYCRA® 250 GSM

NECK & COLLAR
 T67 079 - ROUND NECK WITH FRONT ZIP
 T67 094 - V NECK WITH BACK ZIP
 T67 110 - V NECK WITH FRONT ZIP

DONT LET OUR
 IMAGINATION LIMIT YOURS
DESIGN YOUR OWN



T67 100S/L
 T67 114S/L

DYO NETBALL DRESS FULL SUB WITH SIDE PANELS

SIZING	FITS	FABRIC
8 - 20	WOMENS	93% POLYESTER 7% ELASTINE SUBLIMATE

NECK & COLLAR
 ROUND NECK, SHORT AND LONG LENGTH

SPECIAL FEATURES
 DYO SUBLIMATE, SELF FABRIC NECK AND ARM BINDING. SHORT OR LONG LENGTH. T67 114S/L RACER BACK



A
B

APOLLO



A
B

BARB

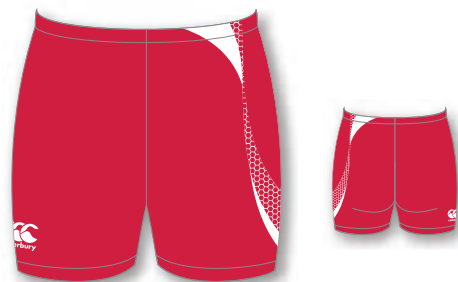

A
B

APOLLO SHORTS



A
B

BARB SHORTS



A
B

ECHO

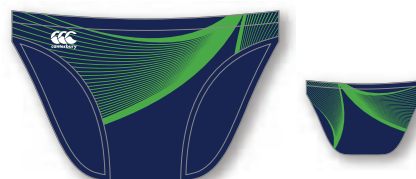

A
B

ECHO BRIEFS



DONT LET OUR
IMAGINATION LIMIT YOURS
DESIGN YOUR OWN

T56 279

MENS & KIDS DYO SUB ATHLETIC SINGLET

SIZING XXS - 5XL 6 - 14	FITS MENS KIDS	FABRIC 100 - SUBLIMATE PERFORMANCE 150GSM 324 - SUBLIMATE PERFORMANCE 180GSM 111 - SUBLIMATE SPORTS MESH 150GSM
SLEEVES SLEEVELESS	NECK & COLLAR ROUND NECK	

SPECIAL FEATURES
NOT SUITABLE FOR WOMEN DUE TO ARMHOLE CUT,
SELF FABRIC NECK AND ARM BINDING



T66 881

WOMENS DYO SUB ATHLETIC SINGLET

SIZING 8 - 24	FITS WOMENS	FABRIC 100 - SUBLIMATE PERFORMANCE 150GSM 324 - SUBLIMATE PERFORMANCE 180GSM 111 - SUBLIMATE SPORTS MESH 150GSM
SLEEVES SLEEVELESS	NECK & COLLAR ROUND NECK	

SPECIAL FEATURES
SELF FABRIC NECK AND ARM BINDING

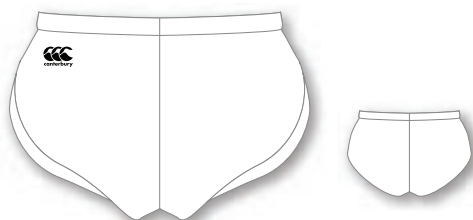

T52 1367 **MENS DYO SUB RUNNING SHORTS**
T72 1367 **KIDS DYO SUB RUNNING SHORTS**

SIZING XS - 3XL 6 - 14	FITS MENS KIDS	FABRIC POLYESTER TASLON 110GSM
SPECIAL FEATURES BUILT IN COTTON BRIEFS		



T52 1368 **MENS DYO SUB NICKS**
T62 2003 **WOMENS DYO SUB NICKS**
T72 1368 **BOYS DYO SUB NICKS**
T72 1389 **GIRLS DYO SUB NICKS**

SIZING XS - 3XL 8 - 18 6 - 14 6 - 16	FITS MENS WOMENS BOYS GIRLS	FABRIC POLYESTER SPANDEX 250GSM
---	--	---



T66 415 **WOMENS DYO SUB CROP TOP**
T76 415 **GIRLS DYO SUB CROP TOP**

SIZING 6 - 20 6 - 16	FITS WOMENS GIRLS	FABRIC POLYESTER LYCRA® 250GSM
NECK & COLLAR ROUND NECK	SPECIAL FEATURES RACER BACK, FRONT AND BACK BRA LINIER, SELF FABRIC NECK AND ARM BINDING, ELASTICATED BOTTOM BAND	

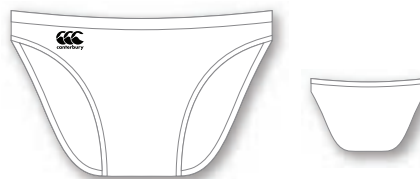

T60 089 **WOMENS DYO SUB RUNNING BRIEFS**
T70 089 **GIRLS DYO SUB RUNNING BRIEFS**

SIZING 6 - 20 6 - 14	FITS WOMENS GIRLS	FABRIC POLYESTER LYCRA® 250GSM
-----------------------------------	--------------------------------	--



VERTICAL STRIPE



SLEEK



TWIN V

DONT LET OUR
IMAGINATION LIMIT YOURS
DESIGN YOUR OWN



T56 800

DYO AFL GUERNSEY

SIZING XS - 4XL 6 - 14	FITS SLIM FIT (ADULTS) CLASSIC (KIDS)	FABRIC SUBLIMATE GUERNSEY 300GSM
SLEEVES SLEEVELESS OR LONG WITH CUFF	NECK & COLLAR V NECK	

SPECIAL FEATURES
ADULTS SLIM FIT ONLY WITH SCALLOPED BACK HEM, KIDS IS CLASSIC FIT ONLY, RIB TRIM AT NECK AND ARMHOLES



GLINT

CUSTOM - FOOTBALL JUMPERS

Please visit www.slatertrellsports.com.au



GULLY



TEST



GULLY PANTS



TEST PANTS

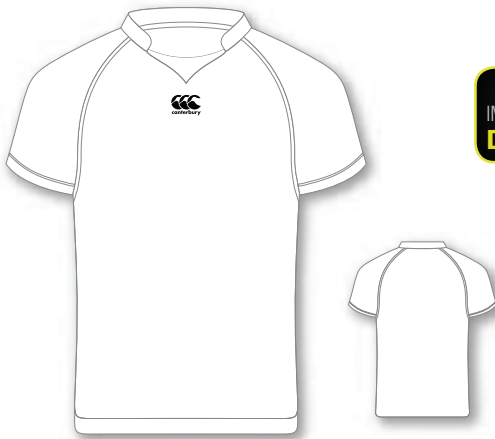

DONT LET OUR IMAGINATION LIMIT YOURS
DESIGN YOUR OWN



T53 2486 - ADULTS
T73 2486 - KIDS
T63 2460 - WOMENS

DYO CRICKET TOP

SIZING

XS - 3XL
6 - 14
8 - 18

FITS

ADULTS
KIDS
WOMENS

FABRIC

100 - SUBLIMATE PERFORMANCE 150GSM
324 - SUBLIMATE PERFORMANCE 180GSM
111 - SUBLIMATE SPORTS MESH 150GSM

NECK & COLLAR

CRICKET V WITH SELF FABRIC V INSERT AND COLLAR

SLEEVES

SHORT OR LONG

T51 1532/L - ADULTS
T71 719 - KIDS

DYO CRICKET PANTS



Please visit www.slatertrellsports.com.au for up to date pricing.



- A
- B
- C

TRAVEL



- A
- B
- C

DRIBBLE



- A
- B

OFFENCE



T56511

MENS DYO MITRED V BASKETBALL SINGLET

<p>SIZING S - 6XL</p>	<p>FITS MENS</p>	<p>FABRIC 100 - SUBLIMATE PERFORMANCE 150GSM 324 - SUBLIMATE PERFORMANCE 180GSM 111 - SUBLIMATE SPORTS MESH 150GSM</p>
<p>SLEEVES SLEEVELESS</p>	<p>NECK & COLLAR V NECK</p>	

DONT LET OUR
IMAGINATION LIMIT YOURS
DESIGN YOUR OWN



T56825 **DYO BASKETBALL SINGLET**
T66825 **DYO WOMENS BASKETBALL SINGLET**
T76825 **DYO KIDS BASKETBALL SINGLET**

<p>SIZING XS-4XL 6 - 24 6 - 14</p>	<p>FITS MENS WOMENS KIDS</p>	<p>FABRIC 100 - SUBLIMATE PERFORMANCE 150GSM 324 - SUBLIMATE PERFORMANCE 180GSM 111 - SUBLIMATE SPORTS MESH 150GSM</p>
<p>SLEEVES SLEEVELESS</p>	<p>NECK & COLLAR ROUND NECK</p>	

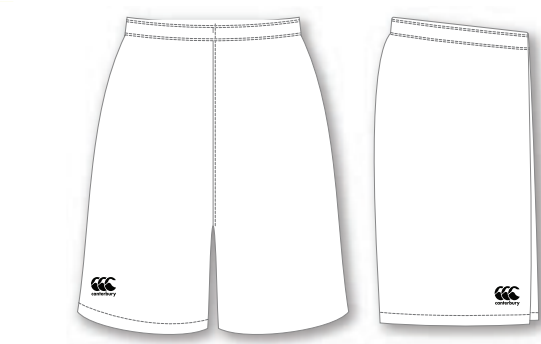

T52862/L **DYO BASKETBALL SHORTS**
T72862 **DYO KIDS BASKETBALL SHORTS**

<p>SIZING XS - 5XL 6 - 14</p>	<p>FITS ADULTS KIDS</p>	<p>FABRIC 100 - SUBLIMATE PERFORMANCE 150GSM 324 - SUBLIMATE PERFORMANCE 180GSM 111 - SUBLIMATE SPORTS MESH 150GSM</p>
<p>SPECIAL FEATURES ADULTS ONLY - REGULAR LENGTH OR LONG LENGTH + 15cm OF REGULAR LENGTH</p>		



PITCHER



SLIDER



T62 1193/S

DYO WOMENS PLAYING SHORTS



SLIDER SHORT



B18 3247

DYO MENS PLAYING TOP

SIZING XS - 8XL	FITS MENS	FABRIC POLYESTER KNIT 235GSM
---------------------------	---------------------	--

SLEEVES SHORT	SPECIAL FEATURES BUTTON THROUGH
-------------------------	---

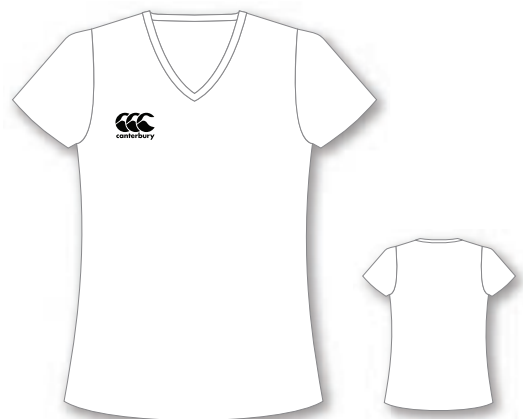

T63 1893

DYO WOMENS PLAYING TOP

SIZING 6 - 24	FITS WOMENS	FABRIC 100 - SUBLIMATE PERFORMANCE 150 111 - SUBLIMATE SPORTS MESH 150GSM
-------------------------	-----------------------	--

SLEEVES SHORT, CAP OR SLEEVELESS	NECK & COLLAR V NECK WITH SELF FABRIC TRIM, V NECK WITH SELF FABRIC TRIM & COLLAR
--	---



SNAKE



EXPLORE



CROWN



RAVEN

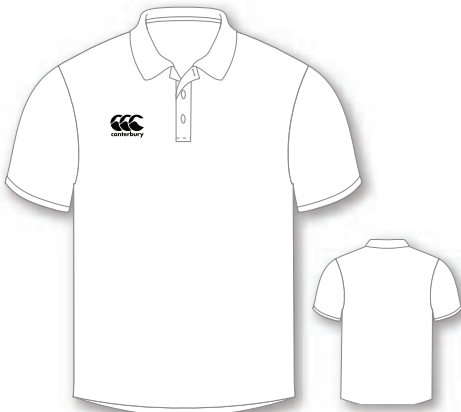

DONT LET OUR
IMAGINATION LIMIT YOURS
DESIGN YOUR OWN

T19 238 **DYO MENS & KIDS SET IN SLEEVE CLASSIC**
 T19 240 **DYO WOMENS SET IN SLEEVE**
 T19 3252 **DYO MENS SET IN SLEEVE SLIM**

SIZING XS - 6XL 6 - 14 8 - 24 XXS - 4XL (SLIM)	FITS CLASSIC KIDS WOMENS SLIM FIT	FABRIC SUBLIMATE SPORTS MESH 150GSM
SLEEVES SHORT	NECK & COLLAR PLAQUET NECK WITH SELF FABRIC COLLAR OR CONCEALED PLAQUET NECK WITH SELF FABRIC COLLAR	
SPECIAL FEATURES SIDE SPLITS WITH BACK TAIL, OPTIONAL POCKET		

T19 239 **DYO MENS & KIDS RAGLAN SLEEVE CLASSIC**
 T19 241 **DYO WOMENS RAGLAN SLEEVE**
 T19 3253 **DYO MENS RAGLAN SLEEVE SLIM**

SIZING XS - 6XL 6 - 14 8 - 24 XXS - 4XL (SLIM)	FITS CLASSIC KIDS WOMENS SLIM FIT	FABRIC SUBLIMATE SPORTS MESH 150GSM
SLEEVES SHORT	NECK & COLLAR PLAQUET NECK WITH SELF FABRIC COLLAR OR CONCEALED PLAQUET NECK WITH SELF FABRIC COLLAR	
SPECIAL FEATURES SIDE SPLITS WITH BACK TAIL, OPTIONAL POCKET		



T55 2090
 A
 B
 C

SIDE WINDER

SIZING XS - 6XL
6 - 14
FITS CLASSIC
KIDS
FABRIC POLYESTER/COTTON FLEECE 280GSM

SLEEVES LONG WITH RIB CUFFS
NECK & COLLAR ROUND RIB NECK TRIM

SPECIAL FEATURES
 FULL ZIP, SIDE POCKETS



T55 2091
 A
 B
 C

ULSTER

SIZING XS - 6XL
6 - 14
FITS CLASSIC
KIDS
FABRIC POLYESTER/COTTON FLEECE 280GSM

SLEEVES LONG WITH RIB CUFFS
NECK & COLLAR ROUND RIB NECK TRIM

SPECIAL FEATURES
 FULL ZIP, SIDE POCKETS



T55 2092
 A
 B
 C

VICTORY

SIZING XS - 6XL
6 - 14
FITS CLASSIC
KIDS
FABRIC POLYESTER/COTTON FLEECE 280GSM

SLEEVES LONG WITH RIB CUFFS
NECK & COLLAR ROUND RIB NECK TRIM

SPECIAL FEATURES
 FULL ZIP, SIDE POCKETS



T55 2093
 A
 B
 C

WARRIOR

SIZING XS - 6XL
6 - 14
FITS CLASSIC
KIDS
FABRIC POLYESTER/COTTON FLEECE 280GSM

SLEEVES LONG WITH RIB CUFFS
NECK & COLLAR ROUND RIB NECK TRIM

SPECIAL FEATURES
 FULL ZIP, SIDE POCKETS
NOTE: Don't use centre front or back screenprints on this style due to centre seam front and back.

T58 1118 - ADULTS
T78 1118 - KIDS



CAPTAIN

SIZING
XS - 6XL
6 - 14

FITS
CLASSIC
KIDS

FABRIC
915 - POLYESTER TASLON 110GSM
998 - POLYESTER MICRO FIBRE 110GSM

SLEEVES
LONG

SPECIAL FEATURES
FULL ZIP, SIDE POCKETS, BOTTOM ELASTICATED SIDE
DRAW CORD

T58 2395 - MICROFIBRE
T58 2398 - TASLON



TAIPAN

SIZING
XS - 5XL

FITS
CLASSIC

FABRIC
998 - POLYESTER MICRO FIBRE 110GSM
915 - POLYESTER TASLON 110GSM

SLEEVES
LONG

SPECIAL FEATURES
PACKAWAY HOOD

T51 842S/R/L - ADULTS
T71 842 - KIDS
T61 842 - WOMENS



STRAIGHT PANEL PANT

SIZING
XS - 4XL
6 - 14
8 - 24

FITS
CLASSIC
KIDS
WOMENS

FABRIC
915 - POLYESTER TASLON 110GSM
998 - POLYESTER MICRO FIBRE 110GSM

SPECIAL FEATURES
SIDE ZIP POCKETS, LEG ZIPS WITH
CUFF ADJUSTERS

T51 843S/R/L - ADULTS
T71 843 - KIDS
T61 843 - WOMENS



PIPED TRACK PANT

SIZING
XS - 4XL
6 - 14
8 - 24

FITS
CLASSIC
KIDS
WOMENS

FABRIC
915 - POLYESTER TASLON 110GSM
998 - POLYESTER MICRO FIBRE 110GSM

SPECIAL FEATURES
SIDE ZIP POCKETS, LEG ZIPS WITH
CUFF ADJUSTERS

T58 810 - ADULTS
T78 810 - KIDS

- A
- B
- C/DYO PANEL
- D/TRIM
- E/CCC LOGOS

STRIP

SIZING
XS - 4XL
6 - 14

FITS
CLASSIC
KIDS

SLEEVES
LONG

FABRIC
915 - POLYESTER TASLON 110GSM
998 - POLYESTER MICRO FIBRE 110GSM

SPECIAL FEATURES
DYO SUBLIMATE PANEL OPTION, FULL ZIP, SIDE POCKETS,
BOTTOM ELASTICATED SIDE DRAW CORD



T58 2625 - ADULTS
T78 2625 - KIDS

- A
- B
- C

TAHS TRACK JACKET

SIZING
XS - 6XL
6 - 14

FITS
CLASSIC
KIDS

SLEEVES
LONG

FABRIC
915 - POLYESTER TASLON 110GSM
998 - POLYESTER MICRO FIBRE 110GSM

SPECIAL FEATURES
FULL ZIP, SIDE POCKETS, BOTTOM ELASTICATED
SIDE DRAW CORD



T51 810S/R/L - ADULTS
T71 810 - KIDS
T61 810 - WOMENS

- A
- B DYO PANEL
- C/TRIM
- D/CCC LOGOS

STRIP PANT

SIZING
XS - 4XL
6 - 14
8 - 24

FITS
CLASSIC
KIDS
WOMENS

SPECIAL FEATURES
SIDE ZIP POCKETS, DYO SUBLIMATE
SIDE PANEL OPTION

FABRIC
915 - POLYESTER TASLON 110GSM
998 - POLYESTER MICRO FIBRE 110GSM



T51 1722S/R/L - ADULTS
T71 1722 - KIDS
T61 1722 - WOMENS

- A
- B
- C

TAHS TRACKPANT

SIZING
XS - 4XL
6 - 14
8 - 24

FITS
CLASSIC
KIDS
WOMENS

SPECIAL FEATURES
SIDE ZIP POCKETS, LEG ZIPS WITH
CUFF ADJUSTERS

FABRIC
915 - POLYESTER TASLON 110GSM
998 - POLYESTER MICRO FIBRE 110GSM





T58 2625 - ADULTS
T78 2625 - KIDS



TAHS TRACK JACKET

SIZING
XS - 6XL
6 - 14

FITS
CLASSIC
KIDS

FABRIC
915 - POLYESTER TASLON 110GSM
998 - POLYESTER MICRO FIBRE 110GSM

SLEEVES
LONG

SPECIAL FEATURES
FULL ZIP, SIDE POCKETS, BOTTOM ELASTICATED
SIDE DRAW CORD



T58 2626 - ADULTS
T78 2626 - KIDS



ALPHA TRACK JACKET

SIZING
XS - 6XL
6 - 14

FITS
CLASSIC
KIDS

FABRIC
915 - POLYESTER TASLON 110GSM
998 - POLYESTER MICRO FIBRE 110GSM

SLEEVES
LONG

SPECIAL FEATURES
FULL ZIP, SIDE POCKETS, BOTTOM ELASTICATED
SIDE DRAW CORD

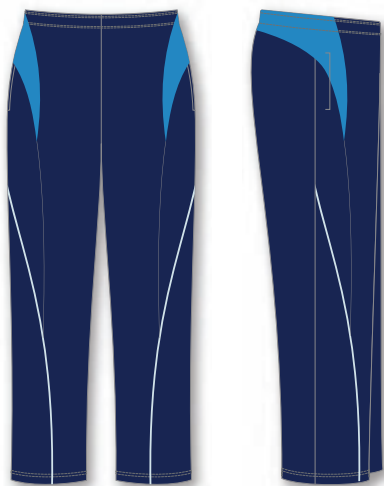

T51 1722S/R/L - ADULTS
T71 1722 - KIDS
T61 1722 - WOMENS



TAHS TRACKPANT

SIZING
XS - 4XL
6 - 14
8 - 24

FITS
CLASSIC
KIDS
WOMENS

FABRIC
915 - POLYESTER TASLON 110GSM
998 - POLYESTER MICRO FIBRE 110GSM

SPECIAL FEATURES
SIDE ZIP POCKETS, LEG ZIPS WITH
CUFF ADJUSTERS

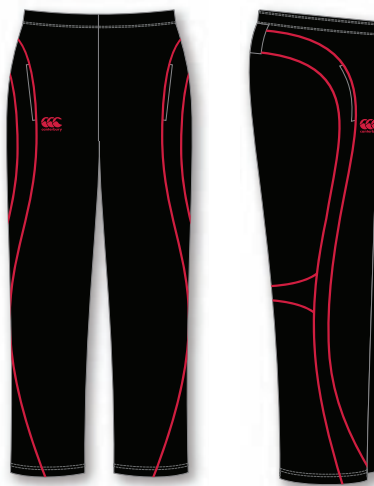

T51 1723S/R/L - ADULTS
T71 1723 - KIDS
T61 1723 - WOMENS



ALPHA TRACKPANT

SIZING
XS - 4XL
6 - 14
8 - 24

FITS
CLASSIC
KIDS
WOMENS

FABRIC
915 - POLYESTER TASLON 110GSM
998 - POLYESTER MICRO FIBRE 110GSM

SPECIAL FEATURES
SIDE ZIP POCKETS, LEG ZIPS WITH
CUFF ADJUSTERS

T58 193 - ADULTS
T78 193 - KIDS



EURO JACKET

SIZING
2XS - 3XL
6-14

FITS
CLASSIC

FABRIC
NYLON RIPSTOP 165GSM

SLEEVES
LONG

SPECIAL FEATURES
OPTIONAL FLEECE OR MESH LINING, POCKETS
FLEECE LINED

T58 2627 - ADULTS
T78 2627 - KIDS



PULSE JACKET

SIZING
2XS - 4XL
6-14

FITS
CLASSIC

FABRIC
NYLON RIPSTOP 165GSM

SLEEVES
LONG

SPECIAL FEATURES
OPTIONAL FLEECE OR MESH LINING, POCKETS
FLEECE LINED, EXTERNAL HOOD OPTION

T58 099



FLEECE VEST

SIZING
2XS - 3XL

FITS
CLASSIC

FABRIC
POLYESTER MICRO POLAR FLEECE 280GSM

SLEEVES
SLEEVELESS

SPECIAL FEATURES
FULL ZIP, SIDE ZIP POCKETS

T55 546



EARNSHAW

SIZING
XS - 4XL

FITS
CLASSIC

FABRIC
POLYESTER MICRO POLAR FLEECE 280GSM

SLEEVES
LONG

SPECIAL FEATURES
QTR NECK ZIP, SIDE ZIP POCKETS

CUSTOM TEAMWEAR

**YOUR TEAM OR CLUB CAN NOW
LOOK LIKE TRUE PROFESSIONALS.**

Slater-Gartrell Sports clothing range offers a combination of high performance fabrics in conjunction with a comfortable and functional fit to meet a player's match and training kit requirements at every level.

Slater-Gartrell Sports understands the needs of teams and our range of high performance stock match shirts, training wear and leisure garments combined with an extensive range of customised options cater for every scenario.

Our specialised design team can assist and advise on every aspect of incorporating your specific school, club or university colours onto any garment.

Our embroidery and printing facilities allow quick turnaround on stock items which can all be embellished with your club logo, numbers and or sponsor logo.



**SLATER-GARTRELL
SPORTS**



COLLEGE

COLOURS

PLEASE PROVIDE A COLOUR THEME FOR THIS DESIGN



CRUSH

COLOURS

PLEASE PROVIDE A COLOUR THEME FOR THIS DESIGN



RACER

COLOURS

PLEASE PROVIDE A COLOUR THEME FOR THIS DESIGN



VERGE

COLOURS

PLEASE PROVIDE A COLOUR THEME FOR THIS DESIGN



GROVER

COLOURS

PLEASE PROVIDE A COLOUR THEME FOR THIS DESIGN



T55 661

DYO SUBLIMATE JACKET

SIZING

XXS - 4XL

FITS

CLASSIC

FABRIC

BRUSHED BACK POLY 335GSM

SLEEVES

LONG WITH CUFF

SPECIAL FEATURES

FULL ZIP, SIDE POCKETS, RIB WAIST BAND AND CUFFS

Please visit www.slatertrellsports.com.au for up to date pricing.

CUSTOM - LEAVERS JACKETS

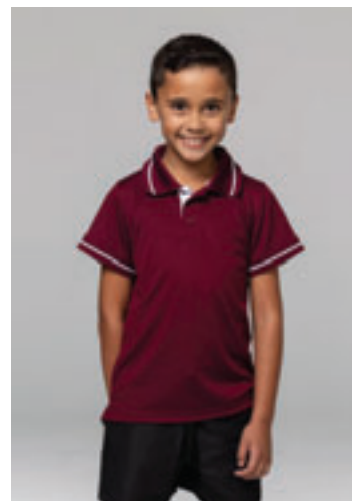
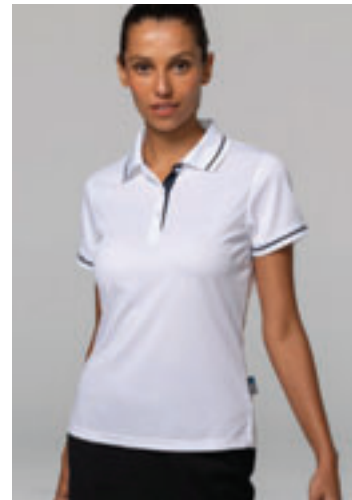

COTTESLOE polo



1319 MENS Size: S-3XL+5XL **2319 LADIES** Size: 6-26 **3319 KIDS** Size: 4-16

TECHNICAL FEATURES

- Fabric Weight: 155gm
- Fabric: 100% polyester **DRYWEAR™** new mesh knit

UNIQUE SELLING POINTS

- Light weight comfortable smart polo + jacquard knitted collar & cuff
- Contrast self fabric inner comfort band & under placket
- Soft and breathable fabric
- Loose pocket included (men's only)
- Side splits for modern fit and enhanced movement

MENS	S	M	L	XL	XXL	3XL	5XL
1/2 CHEST	53	55.5	58	60.5	63	68	73
variations +/- 1 cm (guide only)							

LADIES	6	8	10	12	14	16	18	20	22	24	26
1/2 CHEST	42.5	45	47.5	50	52.5	55	57.5	60	64.5	69.5	74.5
variations +/- 1 cm (guide only)											

KIDS	4	6	8	10	12	14	16
1/2 CHEST	36	38	40	42	44	46	49
variations +/- 1 cm (guide only)							

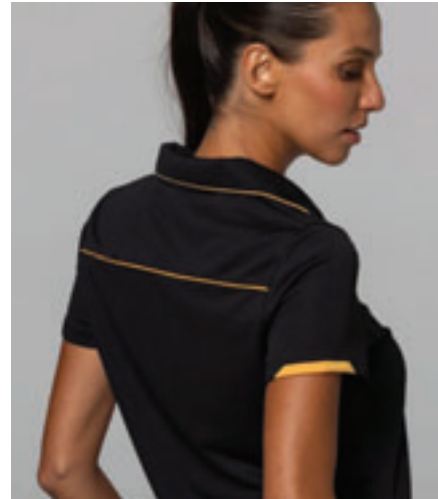

STOCK SERVICE / TEAMWEAR

CURRUMBIN polo



1320 MENS Size: S-3XL+5XL **2320 LADIES** Size: 6-26 **3320 KIDS** Size: 4-16

TECHNICAL FEATURES

- Fabric Weight: 160gm
- Fabric: 100% polyester **DRYWEAR™** mini waffle knit

UNIQUE SELLING POINTS

- Self fabric collar with contrast under collar with piping effect
- Contrast piping at front & back yoke
- Feature contrast centre sleeve hem finish
- Loose pocket included (men's only)
- Side splits for modern fit and enhanced movement

MENS	S	M	L	XL	XXL	3XL	5XL				
1/2 CHEST	53	55.5	58	60.5	63	68	73				
variations +/- 1 cm (guide only)											
LADIES	6	8	10	12	14	16	18	20	22	24	26
1/2 CHEST	42.5	45	47.5	50	52.5	55	57.5	60	64.5	69.5	74.5
variations +/- 1 cm (guide only)											
KIDS	4	6	8	10	12	14	16				
1/2 CHEST	36	38	40	42	44	46	49				
variations +/- 1 cm (guide only)											

Please visit www.slatertrellsports.com.au for up to date pricing.



black/white navy/fluoro orange navy/white slate/fluoro green red/white royal/white white/navy

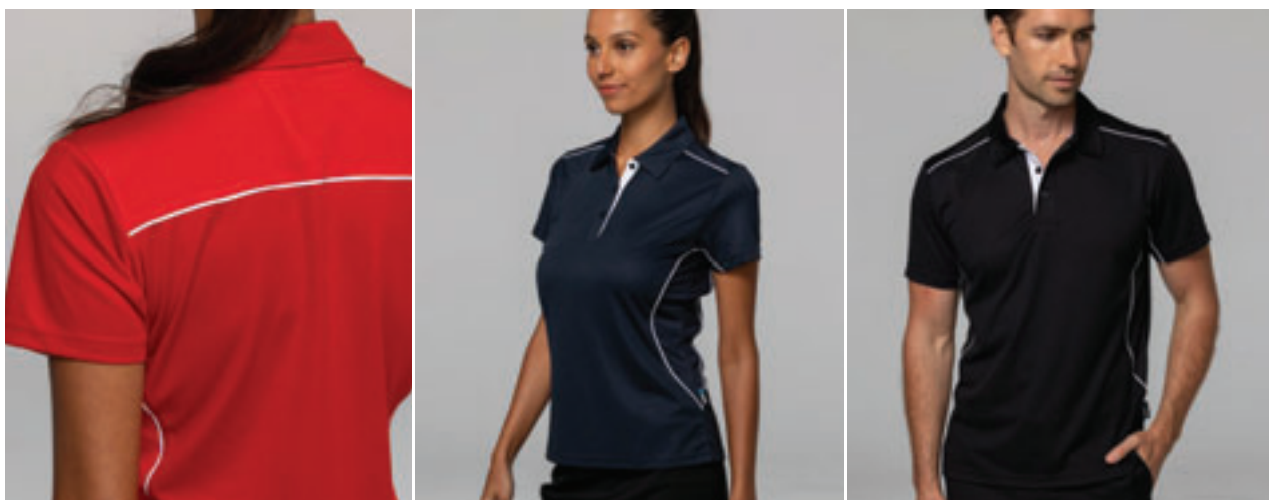

KURANDA polo



1323 MENS Size: S-3XL+5XL **2323 LADIES** Size: 6-26

TECHNICAL FEATURES

- Fabric Weight: 155gm
- Body: 100% polyester **DRWEAR™** new mesh knit
- Panels: 100% polyester **DRWEAR™** ice mesh

UNIQUE SELLING POINTS

- Set in sleeve polo with self fabric collar
- Front & back yoke and side panel in ice mesh with contrast piping
- Under front sleeve panel with contrast piping
- Loose pocket provided (men's only)
- Contrast self fabric under front placket

MENS	S	M	L	XL	XXL	3XL	5XL				
I/2 CHEST	53	55.5	58	60.5	63	68	73				
variations +/- 1 cm (guide only)											
LADIES	6	8	10	12	14	16	18	20	22	24	26
I/2 CHEST	42.5	45	47.5	50	52.5	55	57.5	60	64.5	69.5	74.5
variations +/- 1 cm (guide only)											



black/white white/slate royal/white navy/white slate/black red/white



PORTSEA polo



1321 MENS Size: S-3XL+5XL **2321 LADIES** Size: 6-26

TECHNICAL FEATURES

- Fabric Weight: 180gm
- Fabric: 80% polyester 20% cotton (cotton back fabric)

UNIQUE SELLING POINTS

- Set in sleeve polo with jacquard knitted collar & cuff
- Loose pocket included (men's only)
- Side splits for modern fit and enhanced movement
- Contrast tape at inner comfort band & inner side splits

MENS	S	M	L	XL	XXL	3XL	5XL
1/2 CHEST	53	55.5	58	60.5	63	68	73

variations +/- 1 cm (guide only)

LADIES	6	8	10	12	14	16	18	20	22	24	26
1/2 CHEST	42.5	45	47.5	50	52.5	55	57.5	60	64.5	69.5	74.5

variations +/- 1 cm (guide only)

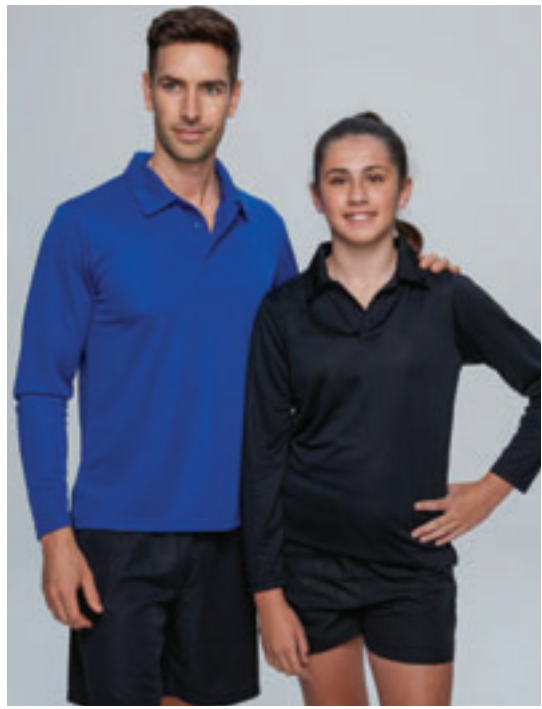

BOTANY L/S polo

1316 MENS Size: S-3XL+5XL 3316 KIDS Size: 4-16



160gm 100% polyester **DRWEAR™** mini-waffle knit, with moisture removal technology, easy care fabric and self fabric collar and a three-button placket. (Loose pocket - mens only).

MENS	S	M	L	XL	XXL	3XL	5XL
1/2 CHEST	53	55.5	58	60.5	63	68	73
variations +/- 1 cm (guide only)							
KIDS	4	6	8	10	12	14	16
1/2 CHEST	36	38	40	42	44	46	49
variations +/- 1 cm (guide only)							



pacific blue/ white

purple/ white

red/ white

royal/ white

silver/ white

slate/ fluoro orange

white/ navy

bottle/ white

black/ fluoro green

black/ fluoro orange

black/ silver

black/ gold

black/ white

black/ red

navy/ fluoro green

navy/ fluoro orange

navy/ gold

navy/ red

navy/ white

ENDEAVOUR polo

1310 MENS Size: S-3XL+5XL 2310 LADIES Size: 6-26



155gm 100% **DRYWEAR™** polyester moisture removal birdseye knit, easy care fabric, traditional piping and self fabric collar.
Ladies has a V neck johnny collar.
Mens has a three-button placket.
(Loose pocket - mens only).

MENS	S	M	L	XL	XXL	3XL	5XL				
1/2 CHEST	53	55.5	58	60.5	63	68	73				
variations +/- 1cm (guide only)											
LADIES	6	8	10	12	14	16	18	20	22	24	26
1/2 CHEST	42.5	45	47.5	50	52.5	55	57.5	60	64.5	69.5	74.5
variations +/- 1cm (guide only)											

Available in mens & ladies only



black/ white (M,L) black/ red (M,L) black/ ashe (M,L) black/ gold (M,L) black/ royal (M,L) black/ teal (M,L) black/orange (M,L) white/ black (M,L) white/ navy (M,L) navy/ red (M,L)

(M,L) = mens & ladies only

Available in mens, ladies & kids



navy/ white navy/ gold navy/ sky pacific blue/ white maroon/ gold



red/ white royal/ white purple/ white gold/ black side view



PATERSON polo

1305 MENS Size: S-3XL+5XL **2305 LADIES** Size: 6-26 **3305 KIDS** Size: 4-16



180gm 80% polyester **DRWEAR™** 20% cotton
moisture removal, cottonback pique knit, easy care fabric with a self
fabric collar and contrast panels.
Three-button placket, kids sizes 4, 6 and 8 only have two buttons.
(Loose pocket - mens only).

MENS	S	M	L	XL	XXL	3XL	5XL
1/2 CHEST	53	55.5	58	60.5	63	68	73

variations +/- 1 cm (guide only)

LADIES	6	8	10	12	14	16	18	20	22	24	26
1/2 CHEST	42.5	45	47.5	50	52.5	55	57.5	60	64.5	69.5	74.5

variations +/- 1 cm (guide only)

KIDS	4	6	8	10	12	14	16
1/2 CHEST	36	38	40	42	44	46	49

variations +/- 1 cm (guide only)

Available in mens & ladies only



black/ electric purple/ white (M,L) black/ electric royal/ white (M,L) black/ electric orange/ white (M,L) black/ red/ gold (M,L) black/ ashe/ white (M,L) slate/ black/ white (M,L) royal/ white/ ashe (M,L) navy/ ashe/ white (M,L)

(M,L) = mens & ladies only

Available in mens, ladies & kids



navy/ white/ ashe navy/ red/ gold red/ black/ white black/ kawa green/ white black/ red/ white side view

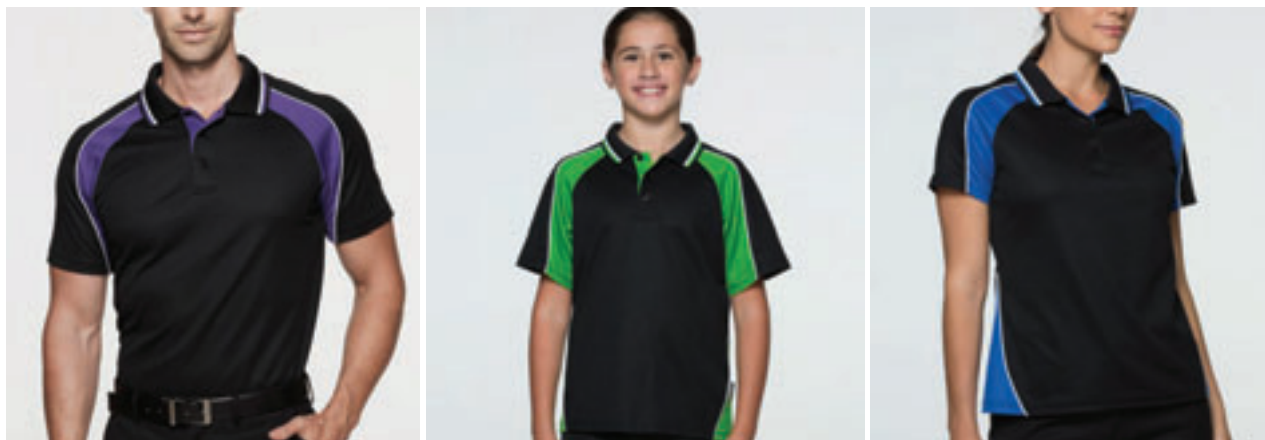

PANORAMA polo

1309 MENS Size: S-3XL+5XL **2309 LADIES** Size: 6-26 **3309 KIDS** Size: 4-16



180gm 80% polyester **DRWEAR™** 20% cotton moisture removal, cottonback pique knit, easy care fabric and traditional knit collar with contrast stripes, panels and piping.

Three-button placket on mens and a two-button placket for kids sizes 4, 6 and 8. (Loose pocket - mens only).

MENS	S	M	L	XL	XXL	3XL	5XL
1/2 CHEST	53	55.5	58	60.5	63	68	73

variations +/- 1 cm (guide only)

LADIES	6	8	10	12	14	16	18	20	22	24	26
1/2 CHEST	42.5	45	47.5	50	52.5	55	57.5	60	64.5	69.5	74.5

variations +/- 1 cm (guide only)

KIDS	4	6	8	10	12	14	16
1/2 CHEST	36	38	40	42	44	46	49

variations +/- 1 cm (guide only)



black/ white black/ red black/ gold black/ neon green black/ cyan black/ ashe (mens & ladies only) black/ teal ashe/ black (mens & ladies only)

navy/ white navy/ red navy/ gold navy/ neon green navy/ sky navy/ neon pink bottle/ white bottle/ gold

royal/ white royal/ red royal/ gold maroon/ white purple/ white red/ white cyan/ black cyan/ neon green

slate/ neon yellow slate/ neon orange slate/ neon pink slate/ neon green neon orange/ slate neon green/ black neon pink/ black neon yellow/ black

TASMAN polo



1311 MENS Size: S-3XL+5XL **2311 LADIES** Size: 4-26 **3311 KIDS** Size: 4-16

TECHNICAL FEATURES

- Fabric Weight: 150gm
- Fabric: 100% polyester **DRYWEAR™** moisture removal micro-knit
- Snag resistant

UNIQUE SELLING POINTS

- Easy care fabric for when you are on the go
- Contrast design elements under collar, side panels, sleeve and placket
- Loose pocket provided (men's only)
- Side splits for modern fit and enhanced movement

MENS	S	M	L	XL	XXL	3XL	5XL
1/2 CHEST	53	55.5	58	60.5	63	68	73

variations +/- 1 cm (guide only)

LADIES	4	6	8	10	12	14	16	18	20	22	24	26
1/2 CHEST	40	42.5	45	47.5	50	52.5	55	57.5	60	64.5	69.5	74.5

variations +/- 1 cm (guide only)

KIDS	4	6	8	10	12	14	16
1/2 CHEST	36	38	40	42	44	46	49

variations +/- 1 cm (guide only)



white/ navy black/ white black/ gold black/ red black/ ashe black/ teal

navy/ white navy/ gold navy/ red royal/ white royal/ gold red/ white

ashe/ black purple/ white bottle/ gold apple/ black burgundy/ white hot pink/ white (L) side view

PREMIER polo



1301 MENS Size: XS-3XL+5XL **2301 LADIES** Size: 8-26 **3301 KIDS** Size: 6-16

160gm 100% polyester **DRWEAR™** mini-waffle knit, with moisture removal technology, easy care fabric, self fabric collar with piping highlights, three-button placket, contrast piping and panels.
 (Loose pocket - mens only).
 Styled V neck for ladies
 PLEASE NOTE: Size XS available while stocks last.

MENS	XS	S	M	L	XL	XXL	3XL	5XL		
1/2 CHEST	50.5	53	55.5	58	60.5	63	68	73		
variations +/- 1 cm (guide only)										
LADIES	8	10	12	14	16	18	20	22	24	26
1/2 CHEST	45	47.5	50	52.5	55	57.5	60	64.5	69.5	74.5
variations +/- 1 cm (guide only)										
KIDS	6	8	10	12	14	16				
1/2 CHEST	38	40	42	44	46	49				
variations +/- 1 cm (guide only)										



EUREKA polo



1304 MENS Size: S-3XL+5XL **2304 LADIES** Size: 8-26 **3304 KIDS** Size: *4-16

160gm 100% polyester **DRWEAR™** mini-waffle knit, with moisture removal technology, easy care fabric, traditional knit collar with contrast signature, coloured highlight piping and a three-button placket.

(Loose pocket - mens only).

Hi Viz mens polo - has pre attached square pocket.

Ladies placket has 4 buttons.

*NOTE: Size 4 available in white/royal, bottle/white, bottle/gold, maroon/white, navy/white, navy/gold, red/white, royal/white, royal/gold, royal/red, sky/navy

MENS	S	M	L	XL	XXL	3XL	5XL
1/2 CHEST	53	55.5	58	60.5	63	68	73

variations +/- 1cm (guide only)

LADIES	8	10	12	14	16	18	20	22	24	26
1/2 CHEST	45	47.5	50	52.5	55	57.5	60	64.5	69.5	74.5

variations +/- 1cm (guide only)

KIDS	*4	6	8	10	12	14	16
1/2 CHEST	36	38	40	42	44	46	49

variations +/- 1cm (guide only)



black/ white/ ashe

black/ orange/ white

black/ red/ white

black/ ashe/ white

royal/ white/ ashe

white/ navy/ ashe

white/ red/ ashe

white/ royal/ ashe

bottle/ white/ ashe

red/ black/ white

navy/ red/ white

navy/ white/ ashe

navy/ gold/ ashe

sky/ navy/ ashe

MURRAY polo

1300 MENS Size: S-3XL+5XL **2300 LADIES** Size: 8-26 **3300 KIDS** Size: 6-16



160gm 100% polyester **DRWEAR™** moisture removal, mini-waffle knit easy care fabric, traditional knit collar with contrast stripes, curved sleeve panel and a 3 button placket.
(Loose pocket - mens only).

MENS	S	M	L	XL	XXL	3XL	5XL
1/2 CHEST	52	54.5	57	59.5	62	64.5	72

variations +/- 1 cm (guide only)

LADIES	8	10	12	14	16	18	20	22	24	26
1/2 CHEST	45	47.5	50	52.5	55	57.5	60	64.5	69.5	74.5

variations +/- 1 cm (guide only)

KIDS	6	8	10	12	14	16
1/2 CHEST	38	40	42	44	46	49

variations +/- 1 cm (guide only)



Disclaimer: Please note neon colours will vary on the actual garment due to the difficulty in matching with printing. Strongly suggest purchasing a sample for assurance.

TASMAN singlet

1111 MENS Size: S-3XL+5XL 2111 LADIES Size: 4-20 3111 KIDS Size: 4-16



150gm 100% polyester **DRWEAR™** moisture removal microknit, snag resistant easy care fabric. Mens and kids have round self fabric neck bind, V neck self fabric neck bind for ladies. Contrast side panels with high light details on sleeve and back neck reflective tab for ear phones.

MENS	S	M	L	XL	XXL	3XL	5XL
1/2 CHEST	51	53.5	56	58.5	61	63.5	68.5

variations +/- 1 cm (guide only)

LADIES	4	6	8	10	12	14	16	18	20
1/2 CHEST	38.5	41	43.5	46	48.5	51	53.5	56.5	59.5

variations +/- 1 cm (guide only)

KIDS	4	6	8	10	12	14	16
1/2 CHEST	35	37	39	41	43	45	48

variations +/- 1 cm (guide only)



black/ cyan

black/ neon green

black/ gold

black/ red



black/ white

slate/ neon green

slate/ neon orange

cyan/ black



cyan/ neon green

navy/ gold

navy/ red

navy/ sky



navy/ white

maroon/ white

royal/ white

bottle/ gold

red/ white



TASMAN tracktop

1611 MENS Size: S-3XL+5XL **3611 KIDS** Size: 4-16

100% polyester soft feel ripstop, contrast colour panels, 2 external zipped pockets, 2 internal pockets, stand up collar, jersey interlock lining and internal zip for easy decoration.

MENS	S	M	L	XL	XXL	3XL	5XL
1/2 CHEST	60	62	64	66	68	70	74
variations +/- 1 cm (guide only)							
KIDS	4	6	8	10	12	14	16
1/2 CHEST	42	45	48	51	54	57	60
variations +/- 1 cm (guide only)							

Please visit www.slatergartrellsports.com.au for up to date pricing.

STOCK SERVICE / TEAMWEAR



black/ white

black/ gold

black/ orange

black/ red

navy/ white

navy/ sky

navy/ red



navy/ gold

royal/ white

royal/ red

royal/ gold



bottle/ white

maroon/ white

red/ white

side view



EUREKA tracktop

1604 MENS Size: S-3XL+5XL **3604 KIDS** Size:6-16

100% polyester Pongee (Chinese silk), contrast colour panels with piping, 2 zipped pockets, stand up collar, jersey interlock lining, internal zip for easy decoration.

MENS	S	M	L	XL	XXL	3XL	5XL
I/2 CHEST	60	62	64	66	68	70	74
variations +/- 1 cm (guide only)							
KIDS	6	8	10	12	14	16	
I/2 CHEST	45	48	51	54	57	60	
variations +/- 1 cm (guide only)							



black/ white

black/ red

black/ gold



black/ orange

red/ white

royal/ white



navy/ white

navy/ gold

navy/ sky

navy/ red

side

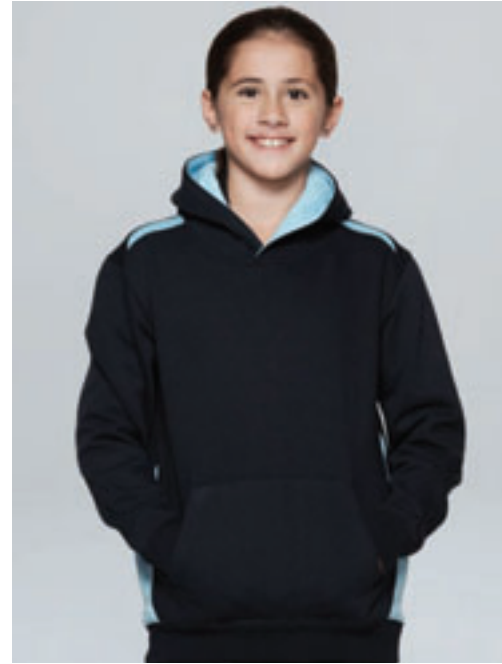

PATERSON hoodie

1506 MENS Size: XS-3XL+5XL **3506 KIDS** Size: 4-16

300gm blended 50% cotton 50% polyester brushed inner jersey knit fleece, low pill, with contrast panels and hood lining and flat tie cord (mens only).

MENS	XS	S	M	L	XL	XXL	3XL	5XL
1/2 CHEST	53.5	56	58.5	61	63.5	66	71	76
SHOULDER TO HEM	69	73	75	77	79	81	83	91
variations +/- 1 cm (guide only)								
KIDS	4	6	8	10	12	14	16	
1/2 CHEST	41	43	45	47	49	51	53	
SHOULDER TO HEM	53	55	57	60	62	64	66	
variations +/- 1 cm (guide only)								

TASMAN sports bag

4001 SPORTS BAG

Features:

- 600d polyester
- no10, heavy duty zips
- large side compartment with ventilation holes
- elasticised mesh pocket on one side
- w: 27.5cm x h: 31.5cm x d: 58cm
- contrast padded shoulder strap
- capacity: 50 litres

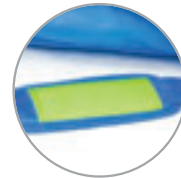

printable flat strap guard

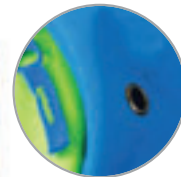

ventilation holes

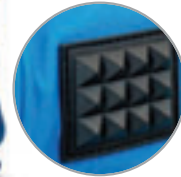

rubber feet

cyan/ neon green

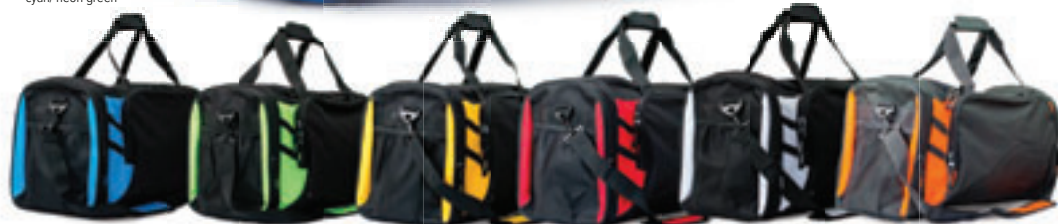

black/ cyan

black/ neon green

black/ gold

black/ red

black/ white

slate/ neon orange



slate/ neon green

cyan/ black

navy/ sky

navy/ white

navy/ red

navy/ gold



bottle/ gold

maroon/ white

red/ white

royal/ white

solid black

solid navy

TASMAN backpack

4000 BACKPACK

Features:

- 600d polyester
- no10, heavy duty zips
- elasticised mesh pockets on both sides
- padded shoulder straps
- contour padded back
- capacity: 28 litres
- w: 31cm x h: 44.5cm x d: 20.5cm



black/ cyan black/ neon green black/ gold black/ red



black/ white bottle/ gold slate/ neon green slate/ neon orange



cyan/ neon green cyan/ black red/ white royal/ white



maroon/ white navy/ red navy/ sky navy/ white navy/ gold



solid navy solid black



black/ red



ID card holder



internal organiser



rubber feet



061-White



021-Grey



047-Yellow



277-Orange



129-Red



063-Burgundy



012-Purple



373-Sky



196-Royal



107-Navy



092-Bottle Green



138-Black



205-Neon Green



200-Neon Orange



215-Neon Pink

AUSTRALIA PLAYER SHIRT S/S

- 100% polyester
- Breathable player shirt
- Quick-drying and moisture wicking

Size 6-8-10-12-XS
S-M-L-XL-XXL-XXXL

SEL700



138-Black



063-Burgundy



129-Red



107-Navy



196-Royal



092-Bottle Green



061-White

AUSTRALIA PLAYER SHORTS

- 100% polyester
- Quick-drying and moisture wicking

Size 6-8-10-12-XS
S-M-L-XL-XXL-XXXL

SEL705

BRAZIL GOALKEEPE SHIRT

- 100% micro polyester
- Flat lock seams and double stitched collar
- Wicking Moisture Management System
- Quick-drying, breathable and lightweight
- Comfortable and durable quality

Size 6-8-10-12-XS
S-M-L-XL-XXL-XXXL

SEL730



Neon Green/Black



Neon Orange/Black



Grey/Black



ARGENTINA GOALKEEPER SHORTS

- 100% micro polyester
- Slim and long
- Wicking Moisture Management System
- Quick-drying, breathable and lightweight
- Comfortable and durable quality

Size 6-8-10-12-XS
S-M-L-XL-XXL-XXXL

SEL706

AUSTRALIA SOCKS

- Leg 100 % Polyester, Foot Cotton/ Spandex and polyester toe and heel
- Strong and comfortable

Sizes 9-12(XS), 13-3(S), 2-8(M), 7-11(L), 11-14(XL)

SEL715



138-Black



61-White



196-Royal



107-Navy



373-Sky



227-Orange



151-Yellow



63-Burgundy



650-Emerald



92-Bottle



12-Purple



200-Fluro Orange



205-Fluro Green



210-Fluro Yellow



215-Fluro Pink



129-Red



AUSTRALIA JERSEY, SHORT & SOCK PACK

Minimum of 10 Packs per Order.

Choose any of the colours listed on the previous pages.

SEL715

Per Pack

CLUB SCARFS AVAILABLE

Minimum Quantity – 25 units 100% Arcylic Jacquard Scarf

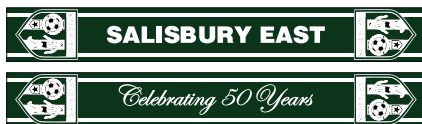

FREE DESIGN SERVICE

Size A : 15.5-16.5cm Wide x 140-145cm Long *** including fringe **Size B** : 17-18cm Wide x 145-150cm Long *** including fringe

Delivery : 3-4 weeks after order confirmation with design sheet **Artwork Required** : AI or EPS

Colours Available: Red, Dark Red, Burgundy, Orange, Aussie Gold, Yellow, Gold, Sky, Royal, Navy, Emerald, Bottle, White, Black, Grey

Please visit www.slatertrellsports.com.au for up to date pricing.

STOCK SERVICE / TEAMWEAR

LOGOS - THERMO FILM OR EMBROIDERY



NUMBERS - 8 INCH OR 4 INCH



NAME - 2 INCH OR 3 INCH



LETTERS - 2 INCH OR 3 INCH



COLOURS

STANDARD

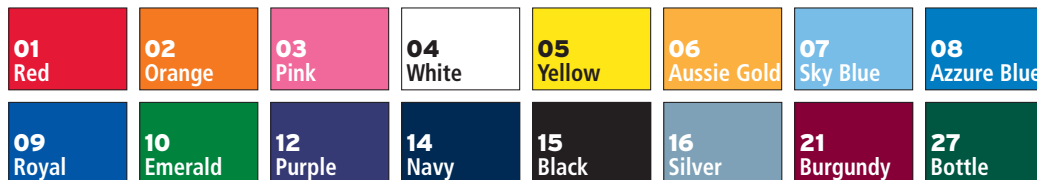

SPECIAL



EMBROIDERY / SCREEN PRINT



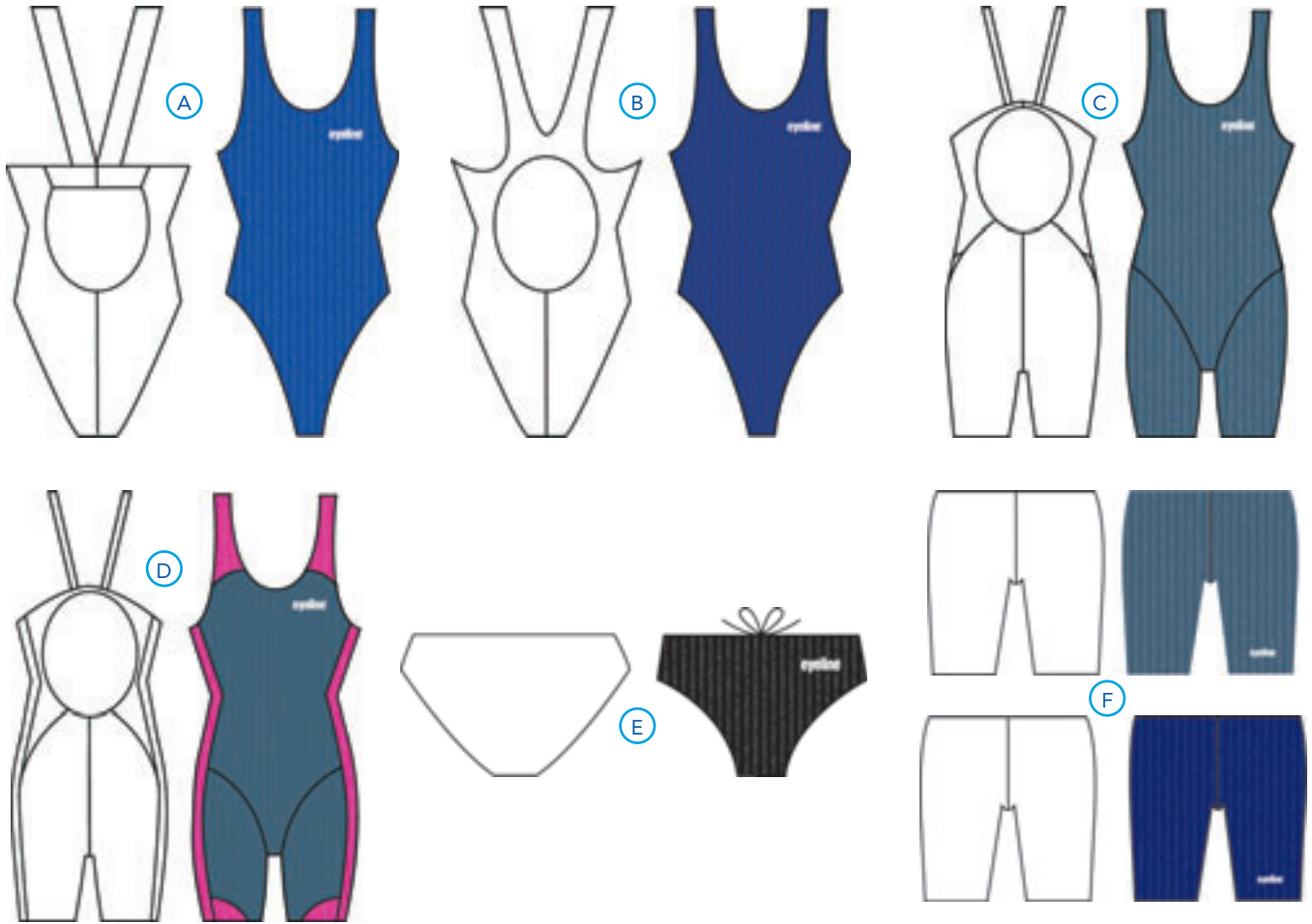

SWIMWEAR - MICROLINE RACING

A. COMP BACK

Embroidered logo full front lined - available in Navy or Royal

Womens sizes 8-14	POA
Girls sizes 6-14	POA

B. SURGE BACK

Embroidered logo full front lined - available in Navy or Titanium

Womens sizes 8-14	POA
Girls sizes 6-14	POA

C. FASTBACK KNEE LENGTH

Embroidered logo crotch lined only
- available in Black, Royal & Titanium

Womens sizes 8-14	POA
Girls sizes 6-14	POA

D. FASTBACK PANEL KNEE LENGTH

Embroidered logo crotch lined only - Titanium / Pink

Womens sizes 8-14	POA
Girls sizes 6-14	POA

E. BRIEF

Embroidered logo full front lined

Mens sizes 14-20	POA
Boys sizes 6-14	POA

F. KNICKS

Embroidered logo gusset lined
- available in Black, Royal & Titanium

Mens sizes 14-20	POA
Boys sizes 6-14	POA

SWIMWEAR RANGE SIZE CHART

Girls Size	2	4	6	8	10	12	14			
Chest (cm)	54	57	59	65	70	75	80			
Waist (cm)	48	50	53	56	60	63	66			
Hips (cm)	58	60	63	69	75	80	85			
Womens Size	8	10	12	14	16	18	20	22	24	26
Chest (cm)	85	89	93	97	101	105	109	113	117	121
Waist (cm)	65	68	72	75	79	83	87	90	94	107
Hips (cm)	90	95	98	102	106	110	114	118	122	126
Boys Size	2	4	6	8	10	12	14			
Waist (cm)	40	45	50	55	60	65	70			
Waist (inches)	16	18	20	22	24	26	27.5			
Mens Size	14	16	18	20	22	24	26	28	30	
Waist (cm)	70	75	80	85	90	95	100	105	110	
Waist (inches)	28	30	32	34	36	38	40	42	44	

TRIATHOLON SIZE CHART

Knicks unisex	XS	S	M	L	XL
Waist (cm)	70	75	80	85	90

6 Wheel Pedal Roller	80	Balance Beams 59		Body Support	188
Acme Whistle	260	Balance Boards	81	Body Tube	98
Adjustable Speed Hurdle	112	Balance Bug Set	80	Bolster	209
ADPE Duo Purpose Mag Bike	104	Balance Disc	79	Books on Sport	48
Aero Ball Barrel	126	Balance Snake	80	Boule	141
Aero Ball Sack	126	Balance Trainer Beam	85	Bow Kit	3
Aerobic Step	99	Ball Cage	229	Bowling Machine Balls	51
Aerosol Canisters	177	Ball Compressor	37	Bowling Markers	55
Aerosol Marker	177	Ball Markers	153	Bownet	145
AFL Post Padding	132	Ball Pressure gauge	217	Bows Archery	3
Agility	110	Ball Pumps	38	Boxing Gloves	101
Agility & Quickness Book	113	Ball Thrower	56	Boxing Head Gear	102
Agility Band	92	Ball Tote on Wheels	256	Boxing Trainers	101
Agility Belt	116	Ball Tote on Wheels	38	Brass Pins	21
Agility Pole Base	112	Ball Tote on Wheels	38	Bucket of Balls	63
Agility Poles	110	Ball Tube Bag	191	Bucket of Tennis Balls	250
Agility Rings	114	Balls Pickleball	205	Buffalo Water Cooler	133
Agility Training Kit	117	Bambino Wings	239	Bum Bag First Aid Kit	87
Air Flow Golf Balls	152	Bandages	186	Bump Pad	138
Air Goal	71	Band-aids	187	Cage Ball	74
Air Horn	13	Barbell	98	Camp Cook Set	195
Air Horns	137	Barricade	76	Campus Brand	126
All In One Portable Stands	257	Base for Free Kick Man	221	Canoe	172
All In One Stand	191	Base Pegs	11	Captains Arm Band	221
All In One Stand Deluxe	28	Baseball	29	Capture the Flag Kit	64
All Round Goal	64	Baseball Bats	30	Cards	43
Alliance Portable Goal Post Set	133	Baseball Bats	30	Catapult Trainer	116
Alpha Goals	144	Baseball Score Card	32	Catch Ball	67
Alphabet Bean Bag Set	61	Baseball Umpire Counter	32	Catchers Cricket Bat	56
Aluminium Soccer Goals Portable	149	Baseballs	29	Catchtail Balls	68
American Footballs	208	Bases	29	Caterpillar	82
American Footballs	208	Basketball	35	Centre Net Strap	252
Amplifier	13	Basketball Backboards	39	Chalk	155
Animal Bean Bag Kit	60	Basketball Bibs	41	Championship Hurdle	16
Animal Bean Bags	60	Basketball Hi Hopper	78	Chess	43
Ankle Elastic	238	Basketball Net	39	Chest Plates	31
Ankle Weights	123	Basketball Nets	39	Chest Plates Baseball	31
Anti Wave Pro 1080 Water Polo Goal	258	Basketball Post padding	39	Chest Plates Softball	31
Aqua Belt	236	Basketball Rings	39	Chime Ball Set	66
Aquatic Ankle & Wrist Straps	236	Basketball Towers	40	Chin Up Tower	103
Aquatic Belt	236	Basketballs	35	Chipping Basket Golf	152
Archery	3	Bat Film	56	Chirpy Rubber Chickens	70
Archery Bows	3	Bat Grips	56	Chlorhexidine Solution	87
Archery Stand	4	Bat Oil	56	Classroom Kits	197
Archery Steps to Success Book	4	Batteries for Stopwatches	227	Club Coloured Footballs	129
Arctic Heat Cooling Vests	87	Battery	176	Club Football	128
Arm Guards Archery	3	Batting Gloves	53	Club Training Kit	100
Arrows Archery	3	Batting Inners	55	Coaching Basketball	67
Athletics Line Marking Bundle	175	Batting Pads Cricket	52	Coaching Basketballs	36
Athletics Trolley	7	Battle Rope Deluxe	99	Coaching Board Carry Bag	47
Attack Football	128	Beach Volleyballs	256	Coaching Boards	44
Award Stickers	22	Bean Bag Ball	61	Coaching Folders	46
Awards	21	Bean Bag Ball Set	61	Coaching Kits	47
Backstroke Flags	235	Bean Bag Kit	61	Cobweb Balls	67
Baden Lexum	255	Bean Bags	10	Collapsible Bench	86
Baden Light Volleyball	255	Beep Test	168	Colour Bean bag Set	61
Baden Matchpoint	255	Beetle Bean Bag Kit	60	Coloured Ball Set	63
Badminton	25	Bibs	41	Coloured Basketballs	35
Badminton Nets	27	Bicycle Pump	217	Coloured Bins	228
Badminton Racquet	25	Big Felt Tennis Ball	67	Coloured Hand Grips	98
Badminton Shuttles	26	Bins	228	Coloured Marquees	184
Badminton Stands	28	Blindfold Set	73	Coloured Skipping Ropes	99
Bag Deluxe Select	38	Board Games	43	Combo Trolley Shot Put and Discus	7
Bag for Free Kick Man	221	Bocce	141	Competition Discus	5
Bails	55	Body Band Rolls	98	Compressor	200
Balance Beam	81	Body Board	239	Compressors	7

Connecta Balance Path	78	Ear Thermometer	169	Foam Fitness Dice	114
Control Markers	201	Early Childhood Learning	59	Foam Fitness Dice	68
Control Punches	201	Easy Catch Ball	64	Foam Frisbee Flyers	71
Core Sliders	92	Eco Balance Cushion	80	Foam Hopscotch Set	72
Coreball	91	Egg & Spoon Race Set Deluxe	73	Foam Javelin	18
Corner Post Set	221	Egg & Spoon Set	72	Foam Juggling Rings	86
Cornilleau Table Tennis	143	Elbow Pads	157	Foam Penguin Bowling Set	70
Crawling Tunnel	82	Electronic Starting Gun	13	Foam Plyo Hurdles	121
Crazy Catch	56	Electronic Whistle	260	Foam Polo Hockey Kit	142
CrazyCatch	206	Elementary Soft PVC Disc	5	Foam Reaction Ball	119
Cricket	50	Elliptical	106	Foam Roller	119
Cricket Balls	50	Elliptical Jump Ball	78	Foam Shapes	85
Cricket Bats	51	Elson Portable Deluxe Volleyball Kit	257	Foam Shot Put	6
Cricket Helmets	53	Elson Portable Volleyball Deluxe Set	141	Focus pads	101
Croquet Set Deluxe	140	Equipment Bag	53	Foldable Water Bottle Carrier	259
Croquet Set Deluxe	65	Exercise mat	114	Folding Stretcher	187
Cross Bar Rests	9	Extreme Soft Big Volleyball	62	Foot Pods	80
Crossnet	141	Ezyline Marker	177	Football	128
Crossnet	256	Fascia Roller	93	Football Bladders	137
Crowd Control Barrier	12	Feather Vanes	4	Football Headgear	133
Cube Bean Bag	61	Fence Post Temporary	10	Footballs	128
Cubline Marker	176	Fibreglass Tape Roll	56	Fountainline	175
Cup Catch Set	69	Field Compass	201	Four Colour Agility Ladder	114
Custom Marquees	184	Field Marker Set	11	Fox Whistle	260
Custom Netball Bibs	192	Field Markers	183	Foxtail Balls	68
Custom Swim Caps	233	Fine Mesh Carry Bags	229	Free Kick Man	221
Cylindrical Post Padding	132	Fineline Bowling Green Marker	177	Frisbee Catcher	71
Darts	198	Finger Tabs	4	Frisbee Flyer	71
Defensive Mannequin	36	First Aid Kits	87	Frisbee Golf	70
Deluxe Bag	38	Fitness	88	Frisbee Golf Basket	140
Deluxe Bag with PVC Base	217	Fitness Circuit Stand	103	Frisbee Golf Basket	152
Deluxe Bags with PVC Base	217	Fitness Dice Set	71	Frisbee Golf Disc Set	140
Deluxe Scoreboard	213	Flag Bunting	10	Frisbees	198
Deluxe Timer	254	Flag Race Bucket	11	Frog Feet	79
Devil Roller Table Tennis	243	Flag Race Flags	11	Future Stars Golf	151
Devil Sticks	86	Flat Hoop	120	Gaiter	196
Diamond Duo Mannequin Yellow	111	Flat Hoops	10	Game Books	43
Diamond Protective Shield	139	Flat Speed ladder	113	Games	43
Digital Score Numbers	55	Fletch Glue	4	Gaol Umpire Coat	137
Dino Egg & Spoon Set	73	Flexi Markers	182	Gar Bag	53
Discus	5	Flexi Markers	182	Garbage Bins	228
Discus Cage	7	Flexiband	94	Gator Balls	254
Discus Carry Bag	6	Flip Over Scoreboard	213	Gator Bals	198
Discus Trolley	228	Flip Over Scoreboard	55	Giant Dart Set	65
Display Flags	185	Flippers	234	Glove Lacing Kit	32
Disposable Oxi Mask	87	Float Belt	236	Gnarloo Fatty Surfboards	173
Dive Discs	235	Floaties	239	Gnarloo Surfboards	239
Dive Rings	235	Floor Mats	100	Go-Go Golf Balls	153
Dive Seahorses	235	Floor Mats Wood	100	Goal Keeping Gloves Soccer	218
Dive Sticks	235	Floor Target	75	Goal Keeping Shirt	222
Divot Tools	153	Floor to Ceiling	100	Goal Umpire Flags	137
Dodgeballs	254	Floorball	126	Goals	144
Dodgeballs	62	Floorball Cage	126	Golf	151
Dome Kit	121	Floorball Goals	126	Golf Balls	152
Dome Markers	182	Floorball Helmets	127	Golf Balls	153
Double Agility Ladder	113	Floorball Protection	127	Golf Buggy	153
Double Scooter Boards	77	Floorball Sticks	126	Golf Clubs	153
Dribbling Goggles	38	Fluro Softball	29	Golf Practice Balls	152
Dual Action Pump	133	Foam Balance Beam	81	Golf Tees	153
Dual Resistance Trainer	115	Foam Bell Ball	66	GPS Devices	159
Duffle Bag	53	Foam Bolster	209	Grip Ball Set	201
Dumbbell	98	Foam Bowling Set	65	Grip Roll	33
Dumbbells	96	Foam Croquet Set	140	Grip Tester	168
Dynamometer	169	Foam Croquet Set	78	Groin Protection	55
Ear Muffs	13	Foam Dice Set	73	Ground Disc Set	183
Ear Plugs	235	Foam Discus	5	Guy Ropes	257

Gym Ball Display Stand	97	Identification	170	Little Anne Manikin	87
Gym Balls	96	Indoor Cricket	57	LoLo Ball Set	79
Gym Mat Trolley	155	Indoor Cycle Bike	105	Long Double Grudge Belt	238
Gym Mats	155	Indoor Rubber Base	112	Long Jump Take Off Mat	11
Gymboss Timer	254	Indoor Shot Put	6	Long Jump Tape Stake	11
Gymboss Timer	98	Indoor Soccer Balls	214	Loumet Gym Balls	96
Gymnastics	154	Inflatable Kickboard	239	Lycra Swim Gloves	236
Gymnastics Chalk	155	Inflator Needles	37	Mag Bike	104
Hack Squat	106	Injury Support	188	Magnetic Strips	47
Half Foam Rollers	81	Inners	55	Manikin Wipes	87
Hammer Throw	7	Instant Heat Pack	187	Mannequin Bag	111
Hand Grips	95	Instant Ice Pack	87	Mannequin Rubber Base	111
Hand Paddles	235	Instant Ice packs	187	Manufacturing	180
Hand Paddles	237	Iron Shot Put	6	Marker Stand	183
Hand Pump Standard	38	Javelin Carry Bag	18	Markers	182
Hand Sanitiser	167	Javelin Hard Tube	18	Marlin Life Jacket	234
Hand Wraps	102	Javelin Storage Trolley	228	Marquees	184
Handball Goals	157	Javelin Storage Trolley	7	Masks Baseball	31
Handball Packs	156	Javelin Trolley	18	Masks Softball	31
Handball Resin	157	Jelly Spike Balls	66	Massage Balls	94
Handball Resin Remover	157	Juggling Balls	86	Massage Table	187
Handball Target for AFL	133	Juggling Diabolo	65	Match Soccer ball	214
Handballs	156	Juggling Plates	86	Matchpoint Ball	255
Handy Height Scale	168	Juggling Rings	86	Measuring Tapes	19
Head Gear for Boxing	102	Jumping Mat	75	Measuring Tool High Jump	9
Heart Rate Monitors	158	Jumping Sack Nylon	75	Measuring Wheels	19
Heat Pads	187	Junior Golf	151	Medallions	23
Heavy Duty Boxing Trainer	101	Kanga Cricket	57	Medals	23
Height Scale	169	Katchit	55	Mediband	89
Helmets Baseball	31	Kayak Paddle	173	Medical	186
Helmets Cricket	53	Kayaks	172	Medisportz	186
Helmets T-Ball	31	Keeping Inners	55	Medium Wedge	85
Hero Balls	62	Kettlebell Rack	96	Megaphones	20
High Bounce Ball	63	Kettlebells	96	Merit Awards	23
High Jump	8	Kick Boards	235	Merit Stickers	23
High Jump Bars	9	Kicking Tee	209	Mess Kit	195
High Jump Mat Trolley	9	Knee Guards Floorball	127	Metal Athletics Marker	11
High Jump Mats	8	Knee pads	157	Metal Athletics Markers	183
High Jump Measuring Stick	9	Knee Pads Volleyball	257	Metal Shot Puts	6
High Jump Stands	9	Knee Support Splint	157	Micro Ball Pump	217
High Stepper	79	Knocken Ball	18	Microband	90
Hockey	164	Knocking In Machine	52	Microband	90
Hockey Ball Cage	165	Knotted Climbing Rope	201	Microbandx	90
Hockey Balls	162	Lacing AWI	137	Milo Cricket	57
Hockey Helmet	164	Lacrosse	225	Mini Airflow Bats	69
Hockey Protection	164	Landing Bun Covers	8	Mini Balance Trainer	79
Hockey Shin Guards	165	Landing Buns	8	Mini Bocce Set	72
Hockey Smock	165	Lane Marker Cone Set	12	Mini Hurdle Cone Set	121
Hockey Sticks	163	Lane Marker Cone Set	183	Mini Pink Balls	255
Hollow Plastic Hoops	10	Lanyards for Whistles	261	Mini Pink Dodge Balls	199
Home Plate	29	Large Block	85	Mini Soccer Ball	67
Hook & Swivel	100	Large Cylinder	85	Mini Tennis Net System	253
Hook & Swivel	102	Large Wedge	85	Mini Tennis Racquet	69
Hoops	10	Lateral Step Trainer	116	Mini Trampoline	103
Hopscotch Gym Mat	73	Leg press	106	Mini Witches Hats	184
Hopscotch Mat	81	Life Jacket	171	Minkey Balls	162
Horseshoe Set	143	Life Saving	171	Mobile Basketball	74
Hurdle Trolley	17	Life Saving Caps	171	Modcrosse	224
Hurdles	16	Life Saving Rescue Tube	171	Modular Components	238
Hygiene	167	Line Marker Battery	176	Modular Set	237
Hyper Cool Towel	95	Line Marking	174	Molten Ball Tote	38
Ice Ball	95	Line Marking Paint	178	Moon Ball	78
Ice Cool Gel Pads	187	Line Marking Parts	176	Mouthguards	135
Ice Pads	187	Line Marking Pumps	176	Mouthguards	189
Ice Spray	188	Linesman Flags Soccer	221	Multi Ball Inflation Device	200
ID Bands	170	Little Anne	171	Multi Coloured Juggling Balls	86

Multi Hurdle Set of 5	111	Plastic Hand Bats	253	Quoits	143
Multi Lane Timer	227	Plastic Hoops	10	Quoits Top Score Rope	201
Multi Number Dice	72	Plastic Knocks	4	Racquet Holder	25
Multi Throw Training Disc	5	Plastic Marker Flags	182	Rainbow Bat Set	69
Multi Use Witches Hats	120	Playball Kit	64	Rainbow Mini Playball Set	63
Mundo	156	Playground Ball	199	Rainbow Parachutes	83
MYO-X2	94	Playground Ball	62	Rainbow Playballs	63
MYOSphere	94	Playmaker Soccer Goals	148	Rainbow Pom Pom Ball	66
MYOStick	94	Plyo Boxes	121	Ranger Compass	201
Neoprene Bands	170	Plyo Hurdles	121	Re-Usable Hot & Cold Compression	87
Nerf Foam Soccer Balls	215	Poles	120	Re-Writable Sign Board	112
Net Clips	220	Polo Hockey	142	Reaction Ball	119
Net Hanger	252	Pom Pom Ball Set	66	Reaction ball	92
Net Ties	217	Ponchos	194	Reaction Balls	111
Net Weight	252	Pool	201	Rebounders	206
Netball	190	Pool Buoys	234	Rectangular Pop Up Goals	149
Netball Bibs	192	Pool Chalk	201	Recumbent Bike	105
Netball Bibs	41	Pool Cue	201	Referee Polo Shirts	39
Netball Gloves	193	Pool Cues	201	Refill Can Air Horn	13
Netball Nets	190	Pool Games	235	Relay Batons	10
Netball Post Pads	191	Pool Noodles	234	Resistance System	88
Netball Ring	191	Pop Up Goal	217	Resistance Training	88
Netball Timers	193	Portable AFL Goal Posts	133	Respect Barrier	220
Netballs	190	Portable Basketball Towers	40	Resuscitation Equipment	87
Nose Clips	235	Portable Dry Spirometer	168	Reversible Netball Bibs	41
Numbered Bean Bag Set	61	Portable Full Size Soccer Goals	149	Rhythm Ribbon Set	83
Numbered Flat Marker Discs	74	Portable Height Scale	169	Ribbons	21
Numbered Marking Cones	184	Portable Netball Stand	191	Rock'N'Hopper	78
Numbered Mat	75	Portable Passing Target	75	Rollers	93
Numbered Playball Set	63	Portable PT Pack	117	Rollout Line	82
Numbered Scarfball Set	68	Portable Stand Weight	28	Roo Ball	29
Numbered Singlets	42	Portable Starting Stand and Light	14	Round Hoop	120
Numbered Witches Hats	184	Portable Tennis Net	253	Round Magnets	47
Off Stump Target	56	Portable Volleyball Stands	257	Round Pop Up Goals	149
Officials Flag	12	Possession Arrows	38	Rounder Bat	80
Onyx Body Roller	119	Post Treadin	10	Rubber Disc	5
Optima Pop-Up Chipping net	152	Power Sled	117	Rubber Dive Animals	235
Orbit Tennis	141	Powertube Plus	88	Rubber Field Markers	182
Orbit Tennis Bats	199	Powertube Plus	88	Rubber Hit Off Mat	153
Orienteering	201	Premier Football	128	Rubber Horseshoe Set	72
Outdoor Play Soccer Goals	147	Printer paper	227	Rubber Quoits	143
Outdoor Table Tennis	241	Pro Speed Sled	115	Rubber Quoits	72
Oz Cricket	57	Pro Training Kit	100	Rubber Volleyball	255
Pace Clock	235	Pro Workout Kit	100	Ruck Bags	138
Pacer Kickboard	235	Professional Rebounder 2.0	206	Rucksack	195
Paddle Ring Set	70	Proline V4 Line marker	176	Rugby Head Gear	209
Paint Bucket	11	Pronto Line Paint	178	Rugby League Balls	207
Parts Line Marking	176	Protection Hockey	164	Rugby Post Padding	209
Patrick Corner Post Set	221	PTP Resistance	88	Rugby Union Balls	207
Patrick Deluxe Bag	38	Pucks	165	Running Spikes	14
Patrick Numbered Singlets	42	Pugg Goals	148	Sack Race	75
Pealess Whistle	171	Pull-Up Bar	91	Safety Practice Disc	5
Personal Mat	259	Pump Action Air Horn	13	Safety Softball	29
Personal Mats	155	Pumps and Compressors	136	Safety Whistle Hunter	194
Physical Education Aids	198	Punching Bag Stand	102	Sand Shark Volleyball	256
Pickleball	205	Punching Bag Wall Brackets	102	Sash	170
Pickleball Net	205	Putters	153	Satchel	47
Pickleball Paddle	205	Putting Alignment Trainer	153	Saturn Ring Ball	68
Pickleball Set	205	PVC AFL Goal Posts	132	Scales	169
Pilates Ball	91	PVC Garden Goals	148	Scissor Mats	8
Pilates Mat Blue	155	PVC School Balls	62	Scoop Ball Set	201
Place Cards	21	PVC Soccer Goals	148	Scoop Ball Set	69
Place Ribbons	21	Pyramid Ball	119	Scoop Stretcher	187
Place Stickers	23	Pyramid Balls	66	Scooter Ball Launchers	77
Plastic Bins	228	Quick Release Harness	116	Scooter Basketball Goals	77
Plastic Cricket	57	Quickster Goals	144	Scooter Boards	77

Scooter Hockey Sticks	77	Softballs	29	Super Connectors	120
Scooter Net Catchers	76	Softy Balls	62	Super Dome Base	120
Scooter Paddles	77	Solera	156	Super Frisbee Flyer Set	71
Scooter Velcro Catchers	76	Solo Bins	228	Super Reaction Ball Set	119
Scoreboard Satchel	56	Space Ball Pack	74	Super Soccer Ball	214
Scoreboards	213	Speed Chute	115	Super Soft Ball Set	63
Scorebook Cricket	56	Speed Hurdles	16	Super Soft Launch Balls	77
Sea Anemone	66	Speed Ladders	113	Super Soft Launch Balls	77
Sector Tape	11	Speed Resistor	115	Superband	90
Seiko	227	Speed Rings Set	114	Surfboards	173
Self Return Hurdle	16	Speed Sled	115	Swift Yardstick	169
Sensory Ball	95	Speed training Kit	117	Swim Belt	238
SG Pop Up Goal	147	Speedballs	100	Swim Caps	233
Shape Bean Bag Set	61	Speeder	226	Swim Exerciser	237
Sherrin Footballs	132	Speedminton	226	Swim Gloves	236
Shin Guards Hockey	165	Sphygmomanometer	168	Swim Goggles	234
Shoe Goo	32	Spike Balls	199	Swim Kick Trainer	237
Short Swim Belt	238	Spike Ball	67	Swimfit	234
Shot Put	6	Spike Discs	182	Swimming	233
Shot Put Carry Bag	6	Spikeball Game Set	141	Swirl Ball	68
Shot Put Stop Block	6	Spin Bike	104	Swiss Ball	78
Shot Put Trolley	228	Spin Tennis	141	Swiss Ball Super Pump	98
Shot Put Trolley	7	Spirit Roller Table Tennis Table	243	Synthetic Discus	5
Shoulder Harness	116	Splash Proof Table Tennis Table	242	Synthetic Turf	55
Shuttle Ball Heavy Duty	64	Sponeta Table Tennis	242	System Stop Watch	227
Shuttle Balls	70	Square Pop Up Goals	149	T-Ball Bats	30
Sidearm Pro	56	Squash	225	T-Ball Kits	31
Silicon Spray	103	Squash Balls	225	T-Ball on a String	32
Silicon Training Fins	234	Squash Safety Glasses	225	T-Ball Stand	33
Silva Compass	201	Squeeze Water Bottle	17	T-Balls	29
Sirens	20	Squeezy Whistle	260	Table Tennis	241
Skateboard Ramp	142	Squistle	260	Table Tennis Balls	246
Skill Balls	66	Stability Disc	91	Table Tennis Bat Holder	243
Skillcoach Shooter Basketball	36	Stackable Tubs	229	Table Tennis Bats	244
Skin Fold Calliper	169	Stand Up Paddle Boards	231	Table Tennis Nets	247
Skip O Hop	72	Standard Dome Base	120	Tackling Bags	138
Skipping Rope Leather	99	Standard Timer	253	Target Butts Archery	3
Skipping Ropes	99	Stands Badminton	28	Target Faces Archery	3
Skipping Ropes Advanced	92	Starting	15	Target Parachutes	83
SKLZ	144	Starting Block Trolley	15	Target Shot Soccer Goal	146
Sleeping Bag	194	Starting Block Trolley	7	Team Partner Chute	82
Sliding Discs	68	Starting Blocks	15	Team Soccer Ball	214
Small Block	85	Starting Clap Board	13	Teamwear	262
Small Cylinder	85	Step for Wave	85	Tennis Ball Cart	251
Small Wedge	85	Step Speed Hurdle	113	Tennis Ball Machines	253
Smash Ball Set	69	Stick O Hop	64	Tennis Ball Serve Doctor	251
Smith Machine	109	Stickers	22	Tennis Ball Trolley	250
Snap Down Basketball Ring	39	Stopwatch	227	Tennis Balls	249
Snooker	201	Storage	228	Tennis Court Squeegee	251
Snooker Chalk	201	Storage Baskets	228	Tennis Grip	248
Soccer Ball Packs	216	Storage Bucket	229	Tennis Net Winder	252
Soccer Balls	214	Storage Trolley	228	Tennis Nets	251
Soccer Balls for Synthetic Grass	215	Strapit	186	Tennis Posts	252
Soccer Bibs	223	Strapping Tape	186	Tennis Racquets	248
Soccer Gloves	218	Street Hockey	165	Tennis Scoreboard	213
Soccer Goals	144	Street Hockey Stick	165	Tent	196
Soccer Hi Hopper	78	Street Soccer Ball	66	Tether Ball	32
Soccer nets	217	Strength Bag	120	Tether Ball Buffalo	63
Soccer Shin Guards	220	Strength Grip	95	Therapy Roller	93
Sock Ties	220	String Bag	38	Therapy Twister	95
Socks	132	String Bags	217	Thermals	196
Sofcrosse	224	Strings Archery	3	Thigh Guards	55
Soft Toss Frisbee Set	71	Stumps	55	Three Leg Race Bands	80
Soft Touch Football	129	Sunscreen	230	Three Steps	85
Softball	29	SUP Boards	231	Thumb Tape	186
Softball Complete Kits	31	Supalite Balls	62	Tiger Feet	79

Timers	193	Volleyball Nets	256
Timers	254	Volleyball Stands	256
Tip It Tower game Kit	76	Volleyballs	255
Toning Balls	97	Volleyballs	255
Total Resistance Systems	88	Vortex Howler	199
Totem Tennis	141	Waist Amplifier	13
Totem Tennis Bats	199	Waist Band	170
Touch Flag Belt Sets	209	Waist Belt	116
Touch Flag Belt Sets	209	Wall Charts	169
Touch Flags	209	Warning Cards	221
Touch Rugby Balls	208	Water Bottle Carrier	259
Touch Rugby Belt	209	Water Bottles	259
Towel X	95	Water Polo Balls	258
Towelling Grip	33	Water Polo Caps	258
Trackball	94	Water Polo Goals	147
Traffic Cone Pole Set	111	Wave	85
Traffic Cones	184	Weight Belts	102
Trainer Cones	120	Weight Bench	103
Training Bag Mitts	101	Weight Gloves Pro	101
Training Cones	184	Weight Plate Rack	103
Training Cones	184	Weight Plate Rack	97
Training Fitness Mitts	101	Weight Plates	97
Training Javelin	18	Weighted Jump Rope	125
Training Javelin Plastic	17	Weighted Vest	123
Training Singlets	42	Wheel Bag	53
Trampolines	254	Wheelie Bag	53
Treadmill	106	Wheelie Bins	228
Triangle	201	Whistles	260
Triflex Set	94	Wicket Keeping Gloves	53
Trigger Balls	95	Wicket Keeping Pads	52
Trophies	23	Wiffle Ball	29
Trophy	23	Wild Child Rebounder 2.0	206
Trunk Tester	168	Wilson Impact Volleyball	255
Tube Ball Bags	217	Wilson Matchpoint Softplay	255
Tubular Agility Ladder	113	Winners Dias	12
Tuff Gator Balls	254	Winners Stand	12
Tuff Skin Balls	198	Wireless Receiver	227
Tuff Skin Balls	62	Witches Hats	184
Tug-O-War Ropes	14	Wooden Discus	5
Tumbling Runs	122	Woods	153
Turbojav Plastic	17	Wool Sock	196
Turned Iron Hammer Throw	8	Wrist Ribbons	83
Turned Shot Put	6	Wrist Support	157
Twelve Sided Dice Set	67	Wrist Weights	123
Twenty Sided Dice	73	X Roller	93
Two Sided Target Face	75	XPE Mat	194
Two Steps	85	Xtreme Line Marking Paint	179
Two Tier Dumbbell Rack	103	Yoga Block	259
Two Way Radio	20	Yoga Mat	259
U-Shaped Magnets	47	York Fitness Pedometer	100
Ultimatch Soccer Ball	214	Zig Zag base	112
Ultra Line Marking Paint	179		
Umpire Counter Cricket	56		
Under Water Hockey	165		
Universal Mats	122		
Upright Bike	104		
Utility Bench	107		
V3 Line Marker Pump	176		
V8 Water Bottle Carrier	259		
Vaifix Wrap	186		
Valve Oil	217		
Velcro Holder for Speed Hurdles	113		
Velcro Net Ties	217		
Velcro Paddle Ball Set	68		
Vibrating Rollers	93		
Victory Podium	12		

COLLAR & NECK OPTIONS

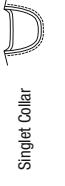
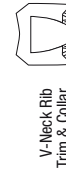

FIT DESCRIPTIONS

Classic Fit

The standard fit garment is a heritage fit and one for all shapes and sizes of players and wearers. This fit is ideally suited for schools, clubs and corporate wearers.

Slim Fit

Our Slim Fit garment range is tailored to the body shape to keep you looking good whilst providing maximum comfort. They are available in both our On & Off Field collection throughout the Canterbury Teamwear catalogue.

Match Fit

The Match fit garment was originally designed for Sevens Rugby, however as the 15s version of the game developed, more emphasis has been placed on the slimmer fitting garments. Our version is designed with the tapered narrower body combined with the narrowed shorter sleeves.

COLOURS

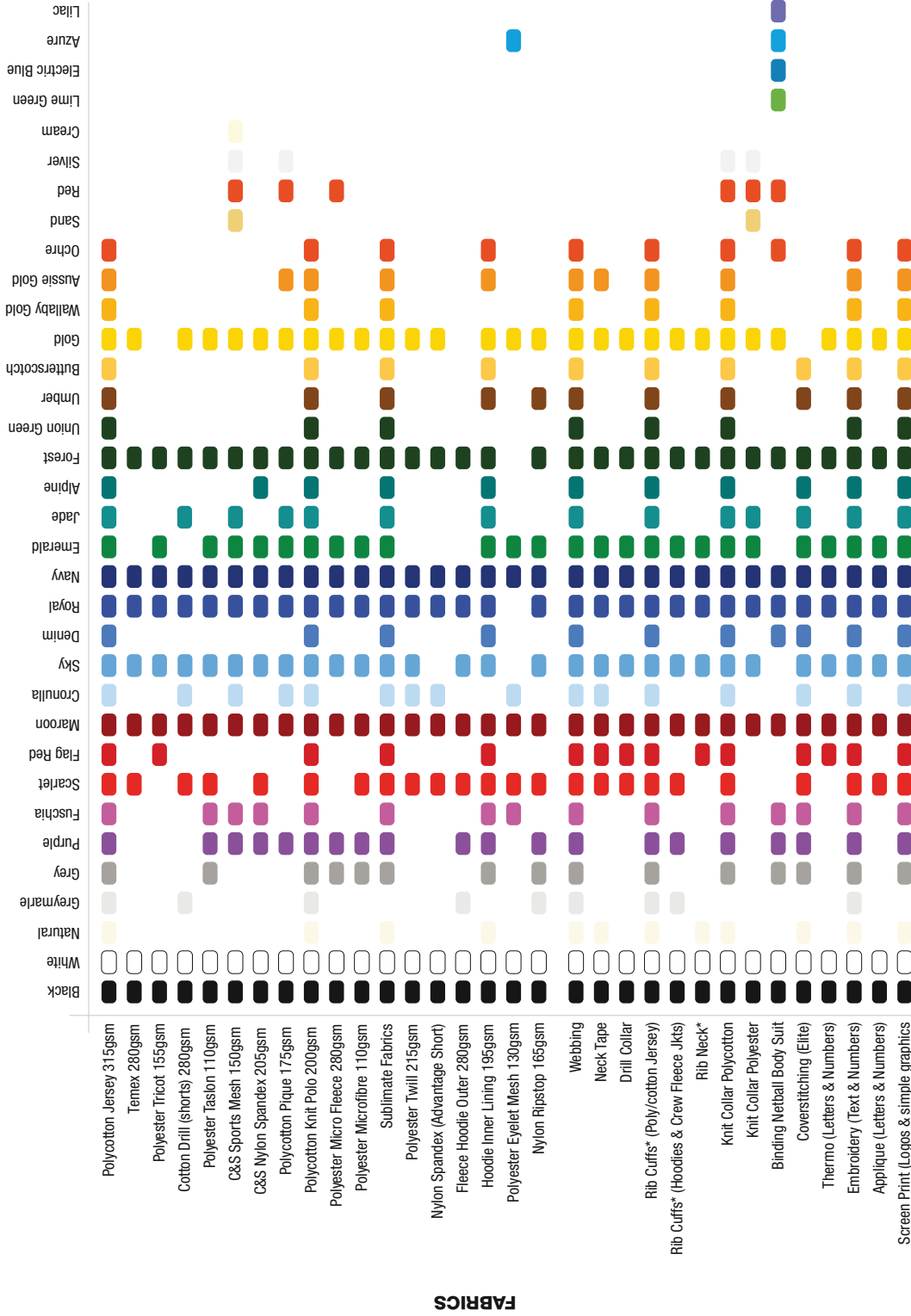

*Rib offered in plain, striped rib is not available.

SG SLATER-GARTRELL
SPORTS

EST.

1978

66 Helena Street, Midland 6056

Incorporating Midland Sports Warehouse
ABN 66 075 692 369

T : (08) 9274 5788

E: sales@slatergartrellsports.com.au

W: slatergartrellsports.com.au